



AIXPLORER mach³⁰

User's Guide

User's Guide Ref. :
SSIP95050-A03
PM.LAB.051-C
September 2018







SuperSonic Imagine

510, rue René Descartes Bat F
13857 Aix en Provence Cedex



SuperSonic Imagine Ultrasound products may be manufactured under or operate in accordance with one or more of the following United States patents and corresponding patents in other countries:

U.S. Patent Numbers:

- (US) 5606971
- (US) 5810731
- (US) 9117439
- (US) 7252004

Other patent applications are pending in various countries.

The software used for this system includes software owned by SuperSonic Imagine and licensed to SuperSonic Imagine by a licensor.

Availability of this software and related documents is restricted.

The software and related documents must be used only for this system.

The intellectual property of this software and related documents is not assigned to you.

You must not copy the software or documents, nor modify the software in whole or in part.

You must not recompile or reassemble the software.

You must not assign, disclose, transfer, or sublicense the software or documents to a third party.

The ultrasound system software is subjected to the US and French Export and Administration Laws and Regulations and you must not export or re-export the software in whole or in part unless properly authorized by the US or French government.

The information in the documents, or programs in the software are subject to change without notice.



CAUTION

No modification of this equipment is allowed.

The following names are trademarked or registered by SuperSonic Imagine, Inc:

- Aixplorer® Mach
- The Theragnostic Company™
- ShearWave™ Elastography
- SWE™ Mode
- Q-Box™
- UltraFast™ Imaging
- SuperCompound™
- UltimateFocus™
- SuperRes™
- TissueTuner™
- SonicTouch™
- SonicSoftware™
- ManualTouchTGC™
- SuperLinear™ 18-5 transducer
- SuperCurved™ 6-1 transducer
- SuperEndocavity™ 12-3 transducer
- SuperLinear™ Volumetric 16-5 transducer
- SuperLinear™ 10-2 transducer
- SuperMicroConvex™ 12-3 transducer
- SuperLinear™ HockeyStick 20-6 transducer
- TouchRing™
- SonicResearch™
- MultiWave™
- Thy-RADS™
- ReportBuilder™
- UltraFast™ Doppler
- PLanewave UltraSensitive™
- SonicPad®

Table of Contents

1. Introduction	1
Welcome!	3
About this User's Guide	3
Training	4
About this Device	5
General Description	5
Intended Use	5
Indications for Use	6
Contraindications	6
Essential Performances	7
Prescription Device	7
Conformance Standards	7
Certifications	9
Contact Us	10
France	10
North America	10
United Kingdom	10
Germany	11
China	11
Service	11
Service	12
Upgrades and Updates	13
2. System Overview	15
Receiving and Storing Aixplorer® Mach 30	17
Storage of the Device	17
Safe Disposal of the Device	17
Temperature, Pressure and Humidity Limits	19
Electrical Operating Requirements	19
Dimensions	20
Description of the System	22
Connecting the Power Cable and Protective Earth	23

Information concerning the terminal to which the potential equalization conductor is to be connected

():	24
Monitor and Articulated Arm	24
Control Panel	27
How to Move the Control Panel Up and Down	27
How to Swivel the Control Panel	28
Speakers and Audio Adjustment	29
Transducers	29
Connecting a Transducer	29
Cable Holders	33
On-Cart Storage	33
Gel Holder/Warmer	33
Storage Areas	36
Input/Output Connectors	37
USB Ports	37
Displayport	39
CD/DVD Drive	39
Printers	40
Integrated Printers (optional)	40
Additional Printer	41
Barcode Scanner (optional)	44
1D Barcode Scanner	45
Compatible Barcode Types	51
Parameter Defaults	52
Additional Video Devices	53
Mobility	55
Handles	55
Brake and Wheel Locks	56
Foot Rest	57
Moving the System	57
Preparing to Move the System	57
Moving the System	58
Compatible Accessories and Kits	59
Compatible Accessories	60
Gels	60
Transducer Sheaths	62
Cleaning Solutions	71
Printer Paper and Toner	71

Biopsy Guides	72
3. Safety	73
Definition of precaution levels	75
Symbols	76
General equipment safety	78
Electrical safety	80
Electromagnetic Interference	81
General information	81
Recommended separation distances between portable and mobile RF communications equipment and Aixplorer® Mach 30	83
Declaration of electromagnetic emissions	86
Declaration of immunity	87
Thermal Safety	89
Mechanical Safety	91
Safely performing ultrasound examinations with the SuperSonic Imagine Aixplorer® Mach 30 system	92
Bioeffects and biophysics of ultrasound interactions	92
Thermal mechanisms	100
Non-thermal mechanisms	107
Benefits of ultrasound versus risks	111
The ALARA principle	114
The output display standard	118
Practicing the ALARA principle	124
Security Management	143
Recommendations regarding use of USB devices ...	144
Alert system	145
4. Getting Started	149
Conventions	151
Conventions used in this user's guide	151
Conventions used in the system	151
Knobology	152
Getting started	158
Turning the system ON and OFF	158
Setting the time and date	161
Setting the language	161
Getting connected to a network	161

Selecting a transducer	161
Beginning an exam	163
Ending an exam	169
Imaging modes	170
General information on imaging modes	170
5. Imaging	173
About System Display	175
About the Imaging Main Display	175
Notification Icons	177
About the Imaging touch screen	180
Common Imaging Controls	180
Freeze	181
Depth	181
Gain	182
Time Gain Compensation (TGC)	182
Focal Zone Management	183
Zoom	184
Left/Right	186
Top/Bottom	186
Dual	186
Play	187
Dual Top/Bottom	187
Hide Patient Name	187
Arbitration	187
Transducer/Clinical Applications	
Compatibility	189
B-mode Imaging	190
Accessing B-mode	190
About B-Mode Main Display	190
About B-Mode touch screen	191
Description of B-mode Imaging Parameters	191
Biopsy	195
Panoramic	197
ShearWave™ Elastography	203
Accessing ShearWave™ Elastography	203
About the SWE™ Main Display	203
About SWE™ touch screen	204
Description of SWE™ Parameters	204
SWE™ Scanning TIPS	209
Color Mode Imaging	211

The Various Color Modes	211
Accessing Color Modes	212
About Color Modes Main Display	212
About Color Modes Touch Screen	213
Description of Color Imaging Parameters	213
COLOR Scanning TIPS	225
Pulsed Wave Doppler Mode	227
Accessing PW	227
About PW Main Display	227
About PW Touch Screen	228
Setting Up PW	228
Description of PW Imaging Parameters	229
PW Scanning Tips	237
Continuous Wave Doppler	238
Accessing CW	238
About CW Main Display	238
About CW Touch Screen	239
Setting Up CW	239
Description of CW Imaging Parameters	240
3D Imaging	246
Accessing 3D Imaging	246
Acquisition	246
Multi-Planar Reconstruction (MPR)	247
Multi Slice (MS)	248
Contrast Enhanced Ultrasound Imaging (CEUS)	253
Accessing CEUS Mode	253
About CEUS Mode Main Display	254
About CEUS mode touch screen	254
Description of CEUS Parameters	255
CEUS Scanning TIPS	259
M-Mode Imaging	261
Accessing M-mode	261
About M-Mode Main Display	261
About M-Mode touch screen	261
Setting Up M-mode	262
Description of M-mode Imaging Parameters	263
M-mode Scanning	265
ECG	267
Setting up the ECG module	267
Description of ECG parameters	270

6. Analysing an image	273
Using body markers	275
How to use body markers	275
Customization	276
Using annotations	276
How to use annotations	276
Annotation mode	277
Group of annotations	277
Moving annotations	277
Annotation Library	278
Home	278
Exit	278
Customization	279
Performing measurements	279
Accessing measurements	279
Basic measurements	280
Other touch screen measurement functionalities ..	300
Labeled measurements	301
Measurement customization	302
Measurement accuracy	302
BI-RADS® analysis	314
BI-RADS® assessment categories	315
Performing BI-RADS® lexicon classification	315
Documenting BI-RADS® lexicon classification with images	316
Thy-RADS™ Analysis	317
Performing Thy-RADS™ lexicon classification	317
Documenting Thy-RADS™ lexicon classification with images	318
7. Reports	321
Description of the report feature	323
Report builder	323
Description of the report builder	323
Patient information	324
Images	324
Measurements	325
Worksheet	326
Conclusion	331
Generating reports	332

Printing reports	332
Exporting reports	332
8. Image and Data Management	333
Saving Data	335
Capturing Images and Clips	335
Reviewing an Exam	337
Printing images	340
Sending a Study	342
Deleting exams and images	347
To delete one or more images	347
To delete exams	348
Image Query and Retrieve	348
General Information about Query-Retrieve	348
Performing a Query	350
Performing a Retrieve	351
Opening pushed DICOM data	352
Displaying and Navigating Retrieved Images	353
Exiting Query and Retrieve	353
Ending an Exam	353
Continuing an Exam	354
9. Customizing the System	355
Description of the System	
Configuration	357
System/Display	357
Description of the System/Display Tab	357
System	358
Regional parameters	360
Exam	361
Customization	362
Device Settings	364
Description of the Device Settings Tab	364
Media Settings	364
Media Association	365
System DICOM options	366
Administration	368
Description of the Administration Tab	368
Devices	369
Ethernet Configuration	372
WIFI Configuration	373

Network Tools	376
Disk Maintenance	377
Medical Staff	379
Presets	380
Description of the Presets Tab	380
Annotation	381
Bodymarker	382
Imaging Presets	385
Measurements	389
Description of the Measurements Tab	389
Measures	390
Labels and Calculations	390
Packages	392
Obstetrics	393
Online Services	398
Online System Update	400
Online Maintenance/Diagnostics	402
Online Servers Configuration	403
How to update software versions and options	404
System Diagnostics	406
10. System Care & Maintenance	409
Changing Printer Paper and Toner	411
Cleaning the System	411
Cleaning Frequency	411
Cleaning the Exterior of the Machine	412
Cleaning the Monitor	413
Cleaning the Touch Screen Display	413
Cleaning the Air Filter	413
Cleaning and Disinfecting the Barcode	
Scanner	415
Maintenance	415
Cleaning and Disinfecting the ECG	
Module	416
ECG leads cleaning instructions	416
ECG end cleaning instructions	417
Cleaning and Disinfecting Transducers	417
Transducer Cleaning Safety	417
Transducer Cleaning and Disinfection Guidance	419

General Cleaning and Disinfection Procedures for the Aixplorer® Mach 30 Transducers	420
Cleaning and Disinfection Products	422
Soaking Limits	425
Additional Information Regarding Cleaning and Disinfection of Ultrasound Transducers	428
11. Troubleshooting	429
.....	431
12. References	433
General References	435
Obstetrical References	439
Fetal Growth Equations and Tables	440
Gestational Age Equations and Tables	443
Estimated Fetal Weight Equations and Tables	446

1 Introduction

Welcome!

Welcome and congratulations on your purchase of the Aixplorer® Mach 30 Ultrasound System.

The following documents are available for the Aixplorer® Mach 30 Ultrasound System:

- **User's Guide**

This User's Guide contains important information regarding the use and safety of the product. Please read this guide carefully and store it in a location where it can be easily accessed.

- **Start Guide** (PM.LAB.092)

The Start Guide contains a quick description of the system as well as basic information regarding the use of the product.

- **Obstetrical References** (PM.LAB.091)

The Obstetrical References Guide contains the detailed obstetrical tables and equations that are used on Aixplorer® Mach 30.

- **Acoustic Table Guide** (PM.LAB.090)

The Acoustic Table Guide contains all acoustic tables for each transducer/mode combination available for Aixplorer® Mach 30.

The Aixplorer® Mach 30 system has been designed with the safety of the operator and patient in mind.

Please read the following chapters thoroughly before you start working with the system.

SuperSonic Imagine guarantees the system will perform as intended only when all cautions and warnings specified in this user's guide are observed.

About this User's Guide

This user's guide contains important information about the use of your ultrasound system.

The features described in this user's guide may be optional. Please contact your local SuperSonic Imagine sales or service representative for further information.

Pictures are not contractual and are only displayed for general information purposes.

It also contains information about contacting SuperSonic Imagine for support.

This guide is intended for use by, or by the order of, and under direct supervision of a licensed physician qualified to direct the use of the ultrasound device.

This guide is intended for users who have been trained or are otherwise familiar with the use of medical ultrasound devices.

Clinical guidance on how to perform an ultrasound examination is not provided in this manual.

This user's guide complies with the following:

- 93/42/EEC European Directive modified by 2007/47/EEC European Directive
- FDA regulation, 21 CFR § 801

Training

In case further information is needed, trainings are advised and available upon request at SuperSonic Imagine. Please contact your local representative for more information.

About this Device

General Description

The SuperSonic Imagine Aixplorer® Mach 30 system is a cart based ultrasound imaging system used to perform diagnostic general purpose ultrasound imaging studies.

The system contains a scan converter and can be coupled to a variety of linear, curved, micro-convex, and motorized linear array transducers to produce images, which are displayed on a LCD monitor.

An adjustable control panel with integrated touch screen allows the user to perform an ultrasound exam quickly and efficiently in accordance with ALARA principles.

The system also allows the user to perform measurements and associated calculations, capture images to digital memory or to an external device (such as a printer), and review diagnostic studies in the form of a report.

The system functions in a manner similar to existing devices and transducers for the imaging modes: B-Mode, M-mode, Color Doppler imaging, Pulsed Wave Doppler, Continuous Wave, Harmonic Imaging, Amplitude Power Doppler imaging, Directional Amplitude Power imaging, Contrast Enhanced Ultrasound Imaging, Elasticity Imaging, and 3D imaging.

Intended Use

The SuperSonic Imagine Aixplorer® Mach 30 ultrasound diagnostic system and transducers are intended for general purpose pulse echo ultrasound imaging, soft tissue elasticity imaging, doppler fluid flow analysis of the human body.

Indications for Use

The SuperSonic Imagine Aixplorer® Mach 30 ultrasound system is indicated for use in the following applications, for imaging and measurement of anatomical structures: Abdominal, Small Organs, Musculoskeletal, Superficial Musculoskeletal, Vascular, Peripheral Vascular, OB-GYN, Pelvic, Pediatric, Urology, Trans-rectal, Trans-vaginal and Neonatal/Adult Cephalic, Non-invasive Cardiac.

In addition, the SuperSonic Imagine Aixplorer® Mach 30 ultrasound diagnostic system and associated transducers are intended for:

- Measurements of abdominal anatomical structures,
- Measurements of broad band shear wave speed, and tissue stiffness in internal structures of the liver and the spleen,
- Measurements of brightness ratio between liver and kidney,
- Visualization of abdominal vascularization, microvascularization and perfusion,
- Quantification of abdominal vascularization and perfusion

The shear wave speed and stiffness measurements, the brightness ratio, the visualization of vascularization, microvascularization and perfusion, the quantification of vascularization and perfusion may be used as an aid to clinical management of adult and pediatric patients with liver disease.

This device is intended for use by, or by the order of, and under the supervision of a licensed physician qualified to use or direct the use of the device¹.

This system should only be used by trained sonographers who are knowledgeable about the risk of excessive acoustic energy in the body, particularly in the case where a great amount of fluid is present in the scanning area.

Contraindications

The Aixplorer® Mach 30 system is not designed for ophthalmic use or any use causing the acoustic beam to pass through the eye.

¹Information delivered by the device must be used by a licensed physician qualified to establish a diagnosis.

The Aixplorer® Mach 30 system is not intended for use with flammable anaesthetics or in conjunction with flammable agents.

Essential Performances

The Aixplorer® Mach 30 Ultrasound System shall be free from noise on a waveform or artefacts or distorting an image or error of a displayed numerical value which cannot be attributed to a physiological effect and which may alter the diagnosis

The Aixplorer® Mach 30 Ultrasound System shall be free from the display of incorrect numerical values associated with the diagnosis to be performed.

The Aixplorer® Mach 30 Ultrasound System shall be free from the display of incorrect safety related indications.

The Aixplorer® Mach 30 Ultrasound System shall be free from the production of unintended or excessive ultrasound output.

The Aixplorer® Mach 30 Ultrasound System shall be free from the production of unintended or excessive transducer assembly surface temperature.

The Aixplorer® Mach 30 Ultrasound System shall be free from the production of unintended or uncontrolled motion of transducer assemblies intended for intracorporeal use.

Prescription Device

Caution: United States federal law restricts the sale of diagnostic ultrasound devices to sale by or on the order of a physician.

Conformance Standards

According to 93/42/EEC European Directive modified by 2007/47/EEC European Directive, Aixplorer® Mach 30 is a Class IIa Medical Device.

According to:

- IEC/EN 60601-1, Equipment is Class I, type BF.
- IEC 60601-1-2, Equipment is Class B.

The product is compliant to the following standards:

- UL 60601-1 Medical Electrical Equipment, Part 1: General Requirements for Safety
- CAN/CSA-C22.2 No. 601.1 Medical Electrical Equipment - Part 1: General Requirements for Safety
- IEC/EN 60601-1-1 Medical electrical equipment – Part 1-1: General requirements for safety – Collateral standard: Safety requirements for medical electrical systems.
- IEC/EN 60601-1-2 Medical electrical equipment – Part 1-2: General requirements for safety – Collateral standard: Electromagnetic compatibility – Requirements and tests.
- IEC 60601-2-37 Medical electrical equipment – Part 2-37: Particular requirements for the safety of ultrasonic medical diagnostic and monitoring equipment.
- IEC 62304 Medical device software – Software life cycle processes
- NEMA UD 2 Acoustic Output Measurement Standard for Diagnostic Ultrasound Equipment
- NEMA UD 3 Standard for Real-Time Display of Thermal and Mechanical Acoustic Output Indices on Diagnostic Ultrasound Equipment
- EN ISO 10993-1 Biological evaluation of medical devices – Part 1: Evaluation and testing
- EN ISO 14971: Medical devices – Application of risk management to medical devices
- IEC/EN 60601-1 Medical electrical equipment – Part 1: General requirements for safety
- IEC 61340-5-1: Electrostatics – Part 5-1: Protection of electronics devices from electrostatic phenomena – General Requirements
- IEC 61340-5-2: Electrostatics – Part 5-2: Protection of electronics devices from electrostatic phenomena – User guide
- EN 50419: Marking of electrical and electronical equipment in accordance with Article 11(2) of Directive 2002/96/EC (WEEE)
- Digital Imaging and Communications in Medicine (DICOM) standard: PS 3 -2017d

Certifications

SuperSonic Imagine is ISO 13485 certified.

SuperSonic Imagine is ISO 14001 certified.

Contact Us

Customer service representatives are available regionally to help answer your questions. Please contact your local SuperSonic Imagine sales or service representative for assistance.

France



SuperSonic Imagine

Les Jardins de la Duranne - Bât E & F

510, rue René Descartes

13857 Aix en Provence Cedex - France

Telephone: +33 (0)442 99 24 32

Telephone: +33 (0)426 70 02 70

E-mail: contactsFR@supersonicimagine.com

North America



SuperSonic Imagine, Inc.

2625 Weston Road

Weston, FL 33331- North America

Telephone: +1(954) 660 3528

E-mail: contactsUSA@supersonicimagine.com

United Kingdom



SuperSonic Imagine Ltd.,

18 Upper Walk

Virginia Water

Surrey GU25 4SN - United Kingdom

Telephone: +44 (0)845 643-4516

E-mail: contactsUK@supersonicimagine.com



Germany

SuperSonic Imagine GmbH

Zeppelinstr. 71 – 73

81669 München - Germany

Phone: +49 89 36036 - 844

Fax: + 49 89 36036 - 700

E-mail: contactsDE@supersonicimagine.com



China

SuperSonic Imagine

Suite 2304, Block D, Ocean International, DongSiHuan ZhongLu,
Chaoyang District, Beijing (100025), China

Phone : +86-10- 85861023/ 2951/ 2917

Fax: + 86-10-8586 2389

E-mail: beijing@supersonicimagine.com

Service

Call your SuperSonic Imagine local representative.

Service

The lifetime of the product is directly impacted by the following variables:

- Hours of clinical operational use of the product
- Hours of clinical non-operation use while the product is energized and in the “on” state
- Environmental exposure of the product with regard to temperature, humidity and pressure
- Appropriate electrical power conditions
- Proper handling and moving of the product
- Proper storage of the product when not in use
- Proper maintenance and cleaning of the product
- Maintenance quality and frequency
- Quality of accessories used with the device

The SuperSonic Imagine Aixplorer® Mach 30 ultrasound system has to be installed by an authorized SuperSonic Imagine sales or service representative.

To optimize operation and maximize the life of the product, we recommend having an annual maintenance performed by a SuperSonic Imagine authorized representative.

Maintenance and service contracts are available.

All repairs must be conducted by a SuperSonic Imagine authorized representative.

Maintenance operations as described in **Chapter 10, *System Care & Maintenance* [409]** can be performed by the user.

Improper installation, repair or maintenance will void any warranties associated with the product.

Please contact a SuperSonic Imagine sales or service representative for further information.

When the Aixplorer® Mach 30 or its accessories do not longer function properly, please contact SuperSonic Imagine.

Upgrades and Updates

Upgrades may be announced that consist of hardware or software improvements.

Updated user information will accompany those system upgrades.

Software updates will also be available via the Online Services feature.

Always verify that you are using the revision of this document appropriate for your product version.

To verify the correct version of the document for your system or to obtain the latest revision, contact your SuperSonic Imagine representative or local distributor.

2 System Overview

Receiving and Storing Aixplorer® Mach 30

Upon delivery and initial installation, please allow SuperSonic Imagine authorized personnel to open the system packaging. If you need to send the device back to SuperSonic Imagine for service, please do not pack it. Contact your Local SuperSonic Imagine representative.

The Aixplorer® Mach 30 system must be installed only by SuperSonic Imagine authorized personnel.

It is imperative to leave the system 48 hours at room temperature before it is first switched on.

Storage of the Device

The Aixplorer® Mach 30 ultrasound system may be stored indefinitely provided that it is done so under ambient conditions which do not exceed the limits outlined in this chapter.

In the case of extremely long periods of storage (greater than 1 year), it is possible that on-board batteries may become discharged.

If you plan to store the system for extended periods of time, please consult your authorized SuperSonic Imagine service representative regarding battery management.

It is also prudent to have a service representative on-site when re-starting the system for the first time after prolonged storage.

Safe Disposal of the Device

The Aixplorer® Mach 30 ultrasound system contains components that are similar to those found in a typical personal computer.

As such, the electronic parts contained within the housing may contain small amounts of lead (electrical components), mercury (electrical components and batteries) and lithium ions (batteries).

The housing is also composed of plastic material, which can be recycled. As SuperSonic Imagine is ISO 14001:2015 certified, please verify with your local regulations regarding recycling of electrical components, plastics and overall safe disposal of this device.

Please contact your SuperSonic Imagine representative for further information.

Temperature, Pressure and Humidity Limits

The system should be operated, stored, and transported within the parameters outlined below.

Either its operational environment must be constantly maintained or the unit must be turned Off.

Condition	Operation	Storage	Transport
Temperature	From 15°C to 35°C (From 59°F to 95°F)	From -20°C to 50°C (From -4°F to 122°F)	From -20°C to 50°C (From -4°F to 122°F)
Relative humidity	From 30% to 80%	From 30% to 80%	From 30% to 80%
Pressure	From 700 hPa to 1060 hPa	From 500 hPa to 1060 hPa	From 500 hPa to 1060 hPa
Altitude	Below 3000 m		

Electrical Operating Requirements

The system contains an internal power supply which is designed to work at the following voltage ranges:

- 100-240V, 50/60Hz, 500W.

Power must be available through a grounded, hospital-grade outlet (UL 60601-1).

Dimensions

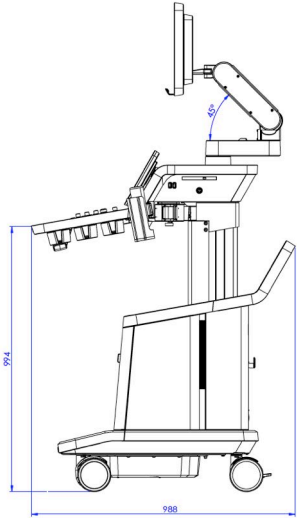
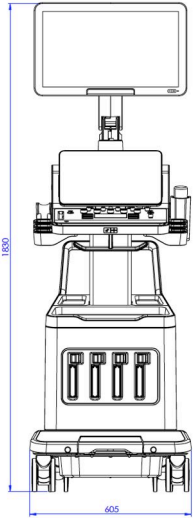
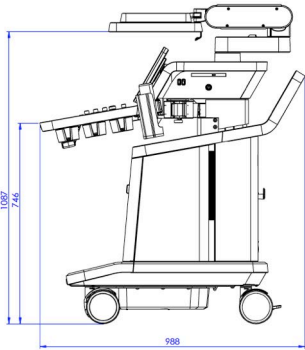
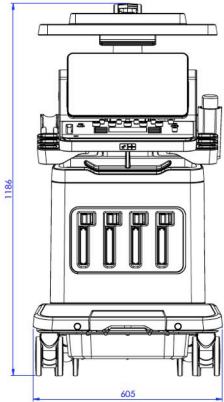

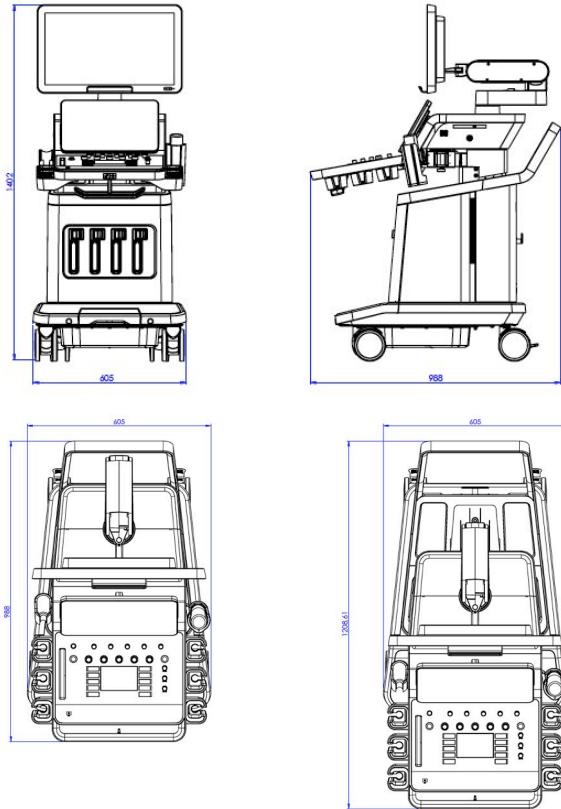

Width: 60.5cm (23.8in)

Height:

- 183cm (72in), with control panel and monitor fully raised
- 140,2cm (55,2in), with control panel in lowest position and monitor in lowest position
- 118.6cm (46.6in), with control panel lowered and monitor in flat position

Depth:

- 98.7cm (38.8in)
- 120,8cm (47.5in), with control panel fully extended

Weight: about 112kg (247 Lbs) without any accessories.

Description of the System

The Aixplorer® Mach 30 system is a cart-based ultrasound system composed of a central processing unit enclosed in a lower housing, an articulated control panel, a touch screen, a monitor and a variety of transducers.



1. Monitor	2. Articulated monitor arm
3. Touch screen	4. Storage areas
5. Handle	6. Transducer connectors
7. Wheel brake	



1. Gel holder/warmer	2. Touch screen
3. Speakers	4. SonicPad®
5. Hand rest	

Connecting the Power Cable and Protective Earth



WARNING

Be sure to connect the power plug to a three-pin grounded outlet meeting the ratings indicated on the rating name plate.

If this type of outlet is not available, contact your SuperSonic Imagine representative.

When the system is correctly plugged in, the on/off button located on the control panel blinks.



CAUTION

The power cable has a locking system preventing it from being unplugged unintentionally.

Make sure you press the red button located on the cable head to unplug it.



Information concerning the terminal to which the potential equalization conductor is to be connected (▽):

To use another medical device in combination with this system, an equipotential wire for connecting to an equipotential bus must be supplied. For more information, contact your SuperSonic Imagine representative. Be sure to connect the potential-equalization lead wire before inserting the equipment power plug into the receptacle. Also, be sure to remove the equipment power plug from the receptacle before disconnecting the wire to avoid electrical shock.

Monitor and Articulated Arm

The monitor is mounted on an articulated arm that permits it to be positioned vertically and horizontally.

You can adjust the position of the monitor to suit different operating positions and operator heights.

When it is released from its locked transport position, the monitor can be tilted up and down, swiveled left and right, and moved from side to side.

To release the monitor from its locked transportation position, rotate the screw on the arm counterclockwise (blue cursor).

For transportation, put the monitor in its lower position and rotate the locker clockwise (red cursor) in order to lock the monitor in this position. If the system needs to be packed for transportation the monitor can be put in flat position.

To adjust the monitor, grasp it by its handle and tilt, swivel or move it.



You can configure the brightness of the screen using the **-/+** buttons located at the bottom right hand corner of the monitor.

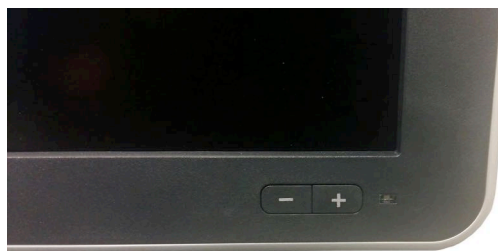



CAUTION

Do not pull the monitor when both the monitor and the control panel are not aligned with the Aixplorer® Mach 30 system. Pulling the monitor when both the monitor and the control panel are positioned as seen on the picture below may cause an imbalance of the system.



Do not push or pull the articulated arm.



Control Panel

How to Move the Control Panel Up and Down

You can adjust the control panel height electrically by doing as follows.

1. Push one of the two buttons located on the front handle as shown below:



2. Do one of the following:
 - To lower the control panel down, push the down button
 - To lift the control panel up, push the up button



CAUTION

When the system is turned off, you can only lower the control panel.

How to Swivel the Control Panel

1. Push the Unlock button located on the front handle (see picture below) and rotate the control panel to the left or to the right for your convenience

You can also pull the control panel towards you



2. Release the button to lock the control panel in desired position.



CAUTION

When in unlocked position, you can slightly move the control panel. If you want to move it freely make sure to push the unlock button as mentioned above.



WARNING

Make sure there is no object or person under the system when moving the control panel down or when swivelling it.

You can also tilt the touch screen. Simply grasp it by the sides and tilt in the desired position according to your needs.



Speakers and Audio Adjustment

The Audio Volume may be adjusted in System Configuration.



CAUTION

Do not get fluids into the speaker grills.

Be sure to clean any unused gel from the surface of the control panel after system use.

Avoid placing fluids close to the speaker grills.

Transducers

Connecting a Transducer

To connect a transducer:

Connect the transducer and push in its compartment, push the lock handle all the way to the left to lock the connector (see picture below).



CAUTION

When not in use, make sure the locker is in unlocked position (pushed to the right).

Make sure the locker is in unlocked position (pushed to the right) before connecting a transducer as follows.



If a transducer is not connected properly, an icon is displayed on the probe tab as follows:

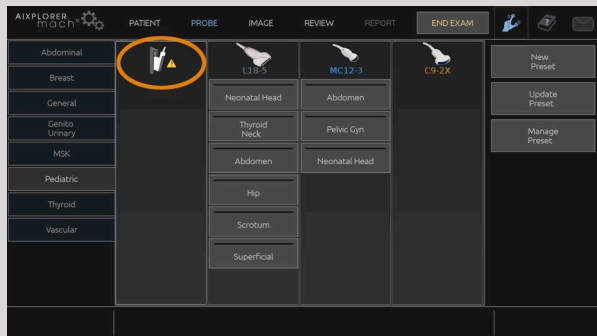

When this icon is displayed, please reconnect the transducer correctly to avoid any hardware or software problems.

When disconnecting the transducer, push the locker all the way to the right to unlock the connector (see picture below) and then hold the connector and pull it straight out.



NOTE

Make sure you hold the transducer the right way. The SuperSonic Imagine transducers are designed with an arrow which indicates the first element.



CAUTION

If a transducer is connected or disconnected with an image displayed, the system and/or the transducer may malfunction.

Do not connect or disconnect a transducer during the system startup or shutdown process. This may result in system malfunction.

If a transducer is dropped or other significant impact occurs, inspect the transducer carefully before use.

Verify that the transducer cover has not been cracked, and the cable and insulation are intact.

If there is any doubt of the integrity of the transducer, discontinue use and contact an authorized SuperSonic Imagine Service Representative.

Cable Holders

You can put the probe cables on the hooks located under the control panel.



On-Cart Storage

Gel Holder/Warmer

An on-cart gel holder has been provided as a convenience.

The gel holder is located on the side of the touch screen.



Standard sized 250ml, diameter 50 mm gel bottles may be placed in the holder for easy access during clinical exams.



TIP

Place gel bottles in the holder with the nozzle down so that the gel is always ready to flow.

Use warm water and a soft bristle brush to remove stubborn dried gel.

A gel warmer has been provided for your convenience. It is directly integrated onto the gel holder. It heats gel to 98,6°F (37°C) in less than an hour.

To activate or deactivate the gel warmer, press the following icon located on the touch screen.

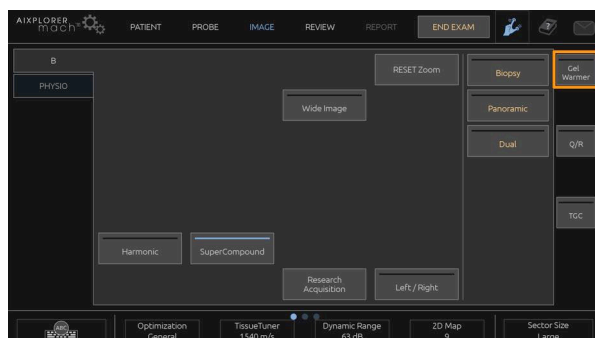



CAUTION

A blue LED indicates that the warmer is powered. It does not mean that it is being warmed.

The gel bottle diameter must be between 49 mm (min) and 52 mm (max) to avoid warming problems.



WARNING

Do not warm the gel too much to avoid the risk of injuries or burns.

Only use the gel warmer with recommended gels for Aixplorer® Mach 30 (please refer to [the section called “Gels” \[60\]](#) for the full list of compatible gels).

Respect the expiry date of the gel.

The system and its accessories are not intended to be used outdoor.



CAUTION

The gel warmer may be cleaned by using a soft, damp cloth and a mild detergent or hospital grade disinfectant, for more information please refer to [Chapter 10, System Care & Maintenance \[409\]](#).

Use care not to wet the electronic controls.

Do not use an abrasive cleaner or isopropyl alcohol to clean the gel warmer.

Do not submerge or immerse the gel warmer in water.

Set the gel warmer properly, in a stable position.

Only use ultrasound gels in the gel warmer. Do not use any other products.

Storage Areas

These areas be may be used to store basic items such as notebooks, charts, DVD's and towels.

The picture below indicates the storage areas as well as the maximum weight you can store for each areas.



You can store a total of 26 kg (57 lbs) on the system, including probe weight.



CAUTION

Do not attempt to open the cart to attach devices.

Call your SuperSonic Imagine sales or service representative for assistance.

Incorrectly connecting electronic devices to the ultrasound system will void all warranties and may result in malfunction, electrical shock or fire.

Do not overload the storage areas on the system.

When storing items, opt for the middle storage area rather than the upper one. Overloading the upper storage area may cause an imbalance of the system.

Excessive loading of the system with peripherals, or stacking peripherals outside of the designated peripheral bay may cause system instability, resulting in the peripheral or system falling over.

Do not load the control panel with heavy items.

Do not lean on the control panel.

Input/Output Connectors

USB Ports



CAUTION

Externally powered USB devices powered are not permitted to be connected to the USB ports of the Aixplorer® Mach 30 ultrasound system.

Any USB device may be connected to the system as long as it is SELF-powered through the USB port (two USB ports can be used) or powered from an external supply IEC60601 (1MOPP) compliant.



WARNING

When using a USB port, ensure that both the user and the patient do not place hands or any other body parts on or in the USB port.

The following ports are available on the system:

- Two USB ports are located on the right side of the control panel



- Three USB ports are located on the rear side of the system
In these USB ports, you can plug the footswitch and a memory stick.
- One isolated USB port is located on the rear side of the system



WARNING

The isolated ethernet and USB ports have the following sticker below them. 



CAUTION

Peripherals that need to be powered directly by the Aixplorer® Mach 30 (such as a USB key or the foot pedal) should not be connected through the isolated USB port.

Make sure to only connect peripherals that are powered by an external source through the isolated USB port. As an example, plugging the footswitch on the isolated USB port may slow down the system.

A two-pedal KINESIS footswitch is provided with the Aixplorer® Mach 30 (optional).

Displayport

A displayport as well as adapters allowing you to switch from displayport to VGA, DVI and HDMI, are provided with the system.



CAUTION

Only equipments compliant with IEC 60601-1 may be connected to the displayport.

An external monitor which supports DVI capability may be connected through the displayport.

For more details, see [the section called “Additional Video Devices” \[53\]](#).

CD/DVD Drive

The CD Drive is located on the left side of the control panel:



The CD/DVD drive supports the following media:

- DVD-R (SL)
- DVD-R (DL)
- DVD+R (SL)
- M-Disc DVD(DVD+R)
- DVD+R (DL)
- DVD+RW
- DVD-RW
- DVD-RAM
- CD-R
- CD-RW

To eject a CD/DVD:

1. Click on the appropriate icon (CD or DVD)

The job list is displayed

2. Press the Eject button to eject the CD or DVD

For information on icons, refer to [the section called “Notification Icons” \[177\]](#).

If you need to manually eject the CD/DVD, insert one end of a paper clip in the hole located right next to the CD/DVD player.

Printers

Integrated Printers (optional)

A SONY black and white thermal printer is integrated on the system. It is located at the rear of the cart.

The SONY black and white thermal printer provided with the system should remain on.

It will stay in an energy-saving mode. Turning Off and restarting the printer stresses the Aixplorer® Mach 30 system and could cause other electrical problems.

Additional Printer

You may want to plug an additional printer to your Aixplorer® Mach 30 device.



WARNING

Never plug a printer that does not comply with IEC 60601-1 standard to a USB port of your Aixplorer® Mach 30. If external peripheral is not connected to the isolated USB port, the External peripheral equipment must be in compliance with related IEC standards for safety. The electrical medical systems conformance to IEC60601-1-1: 2000 or IEC60601-1: 2012 must be verified. All devices meeting IEC60950 must be kept outside of the patient environment, as defined in IEC60601-1-1.

Commercial devices such as printers and external monitors, usually exceed allowable leakage current limits and, when plugged into separate AC outlets, are in violation of patient safety standards. Suitable electrical isolation of such external AC outlets, or providing the device with extra protective earth, will be required in order to meet IEC60601-1 standards for electrical leakage.

Please refer to the list of compatible printers below. These printers are compatible with your Aixplorer® Mach 30 device and should be connected through the isolated USB port. If you use printers that are not listed, make sure they are compliant with IEC60601-1.

If the printer complies with the IEC 60950 standard, perform the following steps:

1. Make sure that the Aixplorer® Mach 30 device is connected to the network (the isolated Ethernet port is located at the rear of the cart)
2. Plug the power cable of your external printer to the wall plug
3. Plug the network cable of your external printer to the network
4. Turn your external printer on
5. Configure the Aixplorer® Mach 30 system to connect to the printer on the same network



NOTE

The Aixplorer® Mach 30 and the external printer may be plugged into the same network at your facility.

If the printer complies with the IEC 60601-1 standard, perform the following steps:

1. Plug the power cable of your external printer to the wall plug
2. Do one of the following, depending on the printer model:
 - connect the printer to Aixplorer® Mach 30 with the USB cable
 - connect the printer to Aixplorer® Mach 30 with the network cable

The following printers are recommended for Aixplorer® Mach 30. The Aixplorer® Mach 30 system is compatible with most Generic PostScript printers.

Sony:

- Embedded UP-D898DC

HP:

- LaserJet Pro 400 M451dn
- LaserJet CP2025dn
- LaserJet P2025dn
- LaserJet M651

Canon:

- imageRunner C6870U
- imageRunner C6800
- ImageClass MF4770n

Konica Minolta:

- bizhub C550

Xerox:

- Phaser 8560AN

- Phaser 8570AN
- Phaser 8860
- ColorQube 8550
- ColorQube 8570
- ColorQube 8580
- ColorQube 9303
- VersaLink C500

RICOH:

- Aficio SP C831DN
- Aficio SP 6330N
- Aficio MP C7501
- Pro C7110S

SAMSUNG:

- CLX-8380
- ML-4050

OKI:

- c531dn
- c511dn
- c6150

OCE:

- PPC5160
- VarioPrint 2105
- VarioPrint 2110

Barcode Scanner (optional)

The Aixplorer® Mach 30 supports a model of hand-held barcode scanner especially designed for healthcare applications and environments, for logging data as patient ID: barcode scanner (JADAK Flexpoint HS-1M).

If only Patient ID is acquired from barcode scanner, the Patient ID can be acquired reading in Patient, Worklist or Q&R Aixplorer® Mach 30 screens.

When delivered by SuperSonic Imagine, the HS-1M barcode scanner is factory programmed and therefore doesn't need any customizations by the user. If you need to change these settings, programming is accomplished by scanning the bar codes in this guide or by sending the commands below them.

See [the section called “Cleaning and Disinfecting the Barcode Scanner” \[415\]](#) for details regarding disinfection and cleaning of the HS-1M barcode scanner.



CAUTION

The HS-1M contains a laser based aiming system that is fully compliant with eye safety certifications.

This device emits CDRH/IEC Class 2 laser and IEC Class 1M light.

Do not stare into beam.



NOTE

When not in use you can store HS-1M in an available probe holder.

1D Barcode Scanner

Overview



1.	LED	Green: A barcode was successfully decoded. Red: A data transmission error or reader malfunction occurred.
2.	Scan window	Scan the barcode.
3.	Trigger	Press to decode.

Setting Up the Scanner

Plug the barcode scanner USB cable into a USB port available on the Aixplorer® Mach 30 and ensure the connector is properly secured. When properly plugged in, the barcode scanner emits a sound.

The scanner has factory settings and is set to be used to read 1D barcodes only.

The scanner supports some user-defined functions as introduced below.

For more details, please contact SuperSonic Imagine customer service department.

Settings

KEYBOARD COUNTRY LAYOUT

United States:



KBD_CTY 0

United Kingdom:



KBD_CTY 1

Belgium:



KBD_CTY 21

Denmark:



KBD_CTY 30

Finland/Sweden:



KBD_CTY 26

France:



KBD_CTY 20

Germany:



KBD_CTY 15

Italy:



KBD_CTY 35

Netherlands:



KBD_CTY 31

Norway:



KBD_CTY 28

Portugal:



KBD_CTY 33

Spain:



KBD_CTY 36

GOOD READ INDICATORS

LED - LED on Good Read

The led indicator can be enabled or disabled in response to a good read.



LEDGDRD 1

Enable



LEDGDRD 0

Disable

Beeper - Good Read

The beeper may be programmed On or Off in response to a good read. Turning this option off only turns off the beeper's response to a good read indication. All error and menu beeps are still audible.



BEPGDRD 1

Enable



BEPGDRD 0

Disable

Beeper Volume - Good Read

The beeper volume codes modify the volume of the beep the HS-1M emits on a good read. When set to off, error and menu beeps are still audible.



BEPLEVL 0

Off



BEPLEVL 1

Low



BEPLEVL 2

Medium



BEPLEVL 3

High

Beeper Tone - Good Read

Scan one of the following codes to set the tone or pitch of the Good Read beep.



BEPTONE 0

Low



BEPTONE 1

Medium



BEPTONE 2

High

Beeper Time - Good Read

Scan one of the following codes to set the duration of the Good Read beep.



BEPTIME 0

Short



BEPTIME 1

Medium



BEPTIME 2

Long

Beeper - Power Up Beep

Scan one of the following codes to enable or disable the power-up beep cycle of the scanner.



BEEPPWR 1

Enable



BEEPPWR 0

Disable

VIBRATION

The HS-1M has an optional internal Vibration motor function that can be used to indicate errors, reads / no reads, etc. This can be very helpful in

an environment where an audible beep would be unwanted; for instance in a patient ward at night in a hospital, where patients are sleeping.

Vibration Modes

The HS-1M can use its vibration engine to vibrate in different situations. Use one of the codes below to set the vibration mode of the HS-1M.



Don't Vibrate



Vibrate on error



Vibrate on good read



Vibrate on BEL (from host)



Vibrate on No Read

Vibration Pulse Count

Set the Vibration Pulse count (i.e. number of vibrations) between 1 and 5 pulses. Each pulse's duration will be determined by the vibration time setting (see next page).



1 Vibration Pulse



3 Vibration Pulses



2 Vibration Pulses



4 Vibrations Pulses



VIBNUMB 5

5 Vibration Pulses

Vibration Time

Sets the Vibration (and Pulse) Time in steps of 1 millisecond from 1ms up to 1 second. Several commonly used Vibration Time menu command barcodes are included below.

Sample settings:



VIBTIME 100

Vibration Time = 100ms



VIBTIME 200

Vibration Time = 200ms



VIBTIME 300

Vibration Time = 300ms



VIBTIME 500

Vibration Time = 500ms

MENU BAR CODE SCANNING

As the JADAK HS-1M can be programmed by scanning menu bar codes, there is an option to restrict the ability to scan menu codes. By setting **MNUENAB 0**, you can no longer scan menu programming barcodes. The only command or scannable menu barcode to revert this will be **MNUENAB 1**.



MNUENAB 1

Enable



MNUENAB 0

Disable

Scanning in Hand-Held Mode

1. Ensure all connections are secure

2. Put the pointer over the field to fill in
3. Aim the scanner at the barcode. Press the trigger.



NOTE

Ensure the scan line cross every bar and space of the symbol, see the figure below.



4. Upon successful decode, the reader beeps and the LED turns green.

Compatible Barcode Types

- GS-1 Databar Limited (RSS Limited)
- GS-1 Databar Expanded (RSS Expanded)
- Codabar
- Code 11
- Interleaved 2 of 5
- Code 128
- Matrix 2 of 5
- Code 39
- Code 93
- NW7
- MSI
- EAN/JAN-13
- EAN/JAN-8
- UPC-A
- GS1-128
- UPC-E
- GS-1 Databar (RSS-14)
- UPC-E1

Parameter Defaults

Refer to the following table for parameter defaults of the JadaK HS-1M Barcode Scanner

Option Name	Value	Key
Interface	USB HID Keyboard	HOSTCFG1
Keyboard Country Layout	United States	KBD_CTY 0
Keyboard Control Character Output	Disable	KBD_NPE 0
Numeric Keypad Mode	Disable	KBD_NMPS 0
LED - LED on Good Read	Enable	LEDGDRD 1
Beeper - Good Read	Enable	BEPGDRD 1
Beeper Volume - Good Read	High	BEPLEVL 3
Beeper Tone - Good Read	High	BEPTONE 2
Beeper Time - Good Read	Long	BEPTIME 2
No Reads	Disable No Read	NO_READ 0
No Read Message	No Read Message	NORDMSG
Beeper - Beep on [BEL]	Disable	BEEPBEL 0
Beeper - Power Up Beep	Enable	BEEPPWR 1
Error LED Duration	Error LED duration = 100 ms	ELEDDUR 100
Aimer Mode	Enable	AIMMODE 1
Aimer Delay	Aimer Delay Off	AIM_DLY 0
Vibration Modes	Don't vibrate	VIBMODE 0
Vibration Pulse Count	1 Vibration pulse	VIBNUMB 1
Vibration Time	Vibration time = 100 ms	VIBTIME 100
Trigger Modes	Manual (lever) Trigger	TRGMODE 0
Multiple Symbols Mode	Multiple Symbol Mode Off	MULTSYM 0
Good Read Delay	No Good Read Delay	DLYGDRD 0
Re-read Delay	Re-read delay 0.6 seconds	DLYRERD 600
Transmit AIM ID Character	Don't Transmit AIM ID	XMITCID 0
Prefixes	Disable	PREENAB 0

Option Name	Value	Key
Suffixes	Disable Suffixes	SUFENAB 0
Illumination Brightness	Illumination Brightness High	LEDSPWR 3
Decode Window	Disable Decode Windowing	WINDECE 0
Symbologies	Enable only 1D barcode (no matrix, no QR code)	
Menu Bar Code Scanning	Enable	MNUENAB 1

Additional Video Devices

You may want to attach an additional video device such as a LCD monitor or video projector to your Aixplorer® Mach 30 device.

The video output of the Aixplorer® Mach 30 is digital video, with a native resolution of 1920x1080.

You may connect video devices to the Aixplorer® Mach 30 which are compatible with the port type and support this video resolution. The external video device must comply with the IEC60601-1. To connect your video device with the Aixplorer® Mach 30, perform the following steps:

1. Power your external video device.
2. Be sure your external video device is powered ON, and it is set such that its input is specified to receive signals from the displayport. See the User's guide of the external video device for more details.
3. Connect your external video device to the Aixplorer® Mach 30 by means of a displayport cable*, no longer than 5 m* (15 ft*) in length.
4. Turn on the power of the Aixplorer® Mach 30. The main display will be mirrored on the system display and on the external monitor.

*cable adapter are available to switch from displayport to VGA, DVI and HDMI

*displayport cables of 5 m in length have been tested with Aixplorer® Mach 30. Longer cables may cause digital signal degradation or loss.



NOTE

External video devices which do not support the resolution of 1920x1080 may result in the following:

1. No signal displayed on the external video device
2. A “letterbox” effect where the video display is shown with a black border around the edges.
3. An aspect ratio adjusted signal is displayed. This may result in the image being stretched or compressed to fit the display.

If you experience problems with the video quality or aspect ratio, it is most likely caused by external video devices which do not support the native resolution of 1920x1080. This can be resolved by adding a “digital scaler” between the external monitor and the Aixplorer® Mach 30. For more information, please contact your local SuperSonic Imagine representative.



CAUTION

Additional equipment connected to medical electrical equipment must comply with the respective IEC or ISO standards (e.g. IEC 60950 for data processing equipment). Furthermore all configurations shall comply with the requirements for medical electrical systems (see IEC 60601-1).

Any person connecting accessory equipment to medical electrical equipment is configuring a medical system and is therefore responsible that the system(s) complies with the requirements for medical electrical systems.

Attention is drawn to the fact that local laws take priority over the above mentioned requirements.

If in doubt, consult your local representative or the technical service department.

Mobility

The SuperSonic Imagine Aixplorer® Mach 30 ultrasound system is a transportable cart based system.

The chassis is mounted on four swivel wheels (casters) which allow you to easily roll the system over flat surfaces.

Swivel wheels allow the user to steer the system around corners.



TIP

Pushing the system is much easier and safer than pulling it. Grasp the handles firmly and maintain an upright posture when pushing.

Handles

Handles are provided to comfortably and safely grasp the system while moving.

Large handles located on the control panel and behind the system (see picture below) allow you to firmly and safely grasp the system when moving.



To steer the system, move the handles in the opposite direction you would like the cart to go (e.g. push handles to the right to steer the cart to the left).



WARNING

The handles are not designed to be used to lift the system.

The handles are to be used only to push and pull the system.

To lift the system, it must be secured to a pallet, or be contained in its original shipping crate.

Do not use a hand-truck to move the system.

Brake and Wheel Locks

A brake and wheel locks are provided to stabilize the system when moving, scanning or when storing.

A wheel brake located in the middle of the foot rest and controls the front wheels.



Putting the brake in low position by stepping on it will completely lock the front wheels.

Putting the brake in medium position unlocks the front wheels so they can be moved freely.

Putting the brake in high position locks front the wheels in direction so that they can be moved forward and backward but cannot be rotated.

Stepping on the back wheel locks will completely lock them. Put back wheel locks in high position to move them freely. Only use the back wheel locks to store the system.



CAUTION

Brakes and wheel locks are not intended to stabilize the system on ramps or inclines.

Do not park or store the system on slopes or uneven surfaces.

Foot Rest

A foot rest has been provided for convenience.

A dedicated area is located above the front wheels.

This rest provide an ergonomic option for resting the legs in a neutral position when scanning in a seated position.

Moving the System

Preparing to Move the System

1. Put the control panel back in its parked position

Turn the system power off.

2. Unplug the main power cord, and disconnect any accessory cords (network, etc.).
3. Use the transducer cable management system to raise transducer cables up from wheel level.
4. Remove or ensure that all peripherals and items in the storage area are secure.
5. Lock the articulating monitor arm in its lowest position as follows:



6. Unlock the wheel locks.

Moving the System

1. Grasp the handles at the front of the machine firmly.
2. Keeping an upright posture, push the system forward.
3. Steer by moving the handles in the opposite direction you would like the cart to go (e.g. push handles to the right to steer the cart to the left).



WARNING

Use caution when moving the system. It could cause injury to you or others if it rolls over feet or into shins.

Use the monitor arm and control panel locking mechanisms when moving the system.

Never attempt to lift the system manually.

In order to prevent injury, an aide such as a ramp or elevator must be used.

Exercise caution when going up or down ramps.

Do not push the system from either side with excessive force. The system could tip over.

Do not allow the wheels to roll over accessory cables.

If you encounter any failure of the wheels, handles or braking mechanisms, park the system on a level surface in a safe area, set the wheel locks and discontinue use until the mechanical parts can be inspected by an authorized SuperSonic Image Service representative.

Compatible Accessories and Kits

Under some use conditions, additional materials provided by third-party vendors may be used by clinicians performing exams with the system. The decision to use the system and transducers with third-party products is completely at the discretion of the clinician. The following tables list products which are suitable for use with the Aixplorer® Mach 30 system and transducers. The use of third-party products outside of those on the following lists is to be done at the user's and patient's own risk.

Compatible Accessories

The following accessories are to be used with the Aixplorer® Mach 30 system or its transducers (please refer to specific sections for more information about accessories) :

- Barcode scanner (JADAK Flexpoint HS-1M)
- ECG Module
- Printers, please refer to [the section called “Printers” \[40\]](#) for a full list of compatible printers
- Two-pedal Savant Elite 2 Foot switch by KINESIS
- Ethernet cable, CAT6a SSTP (PIMF) 500Mhz (shielded) AWG26/7
- Wifi dongle Linksys AE3000
- Gels, please refer to [the section called “Gels” \[60\]](#) for a full list of compatible gels
- Sheaths, please refer to [the section called “Transducer Sheaths” \[62\]](#) for a full list of compatible sheaths
- Biopsy Guide, please refer to [the section called “Biopsy Guides” \[72\]](#) for a full list of compatible sheaths
- Cleaners, please refer to [the section called “List of Compatible Products” \[422\]](#) for a full list of cleaner and disinfection products

Gels

Most water-based gels are compatible with the ultrasound system transducers.

The following gels are recommended because of their compatibility with our transducers. Please check whether the recommended products in the tables below are approved for use in your country.

Gel	Sterility	Manufacturer
Aquasonic 100	Non Sterile	Parker Laboratories, Inc
Ultra/Phonic Conductivity	Non Sterile	Pharmaceutical Innovations
Steril Aquasonic 100	Sterile	Parker Laboratories, Inc
Steril Ultrasound Gel	Sterile	Sonogel



WARNING

Use only recommended gels (lubricants). Alternate products can damage the probe and void the warranty.

Transducer Sheaths

Under certain conditions where the transducer may come in contact with mucous membranes, blood or other bodily fluids, the use of a transducer sheath is recommended.



WARNING

The use of a transducer cover is recommended.

After use, the single-use sheath should be removed and discarded.

Endocavity probe must be used with a sterile sheath. If these probes are used to assist biopsy procedures, all of the biopsy accessories should be sterile for the procedure and should be cleaned and resterilized according to manufacturer's recommendations, after each use.

The E12-3 probe should be cleaned and received high level disinfection after use, even if a sterile sheath was used.

Sheaths can fail during use and the level of resulting contamination may not be easily visible.

The following tables list basic information regarding sterile transducer sheaths which will physically fit our ultrasonic transducers. Please check whether the recommended products in the tables below are approved for use in your country.

L18-5



Transducer width 6.58 cm (2.6 in.), cable length 2.1 m (82.7 in.)

Manufacturer	Sterility	Latex/ Latex Free	Description	Product Number	Dimensions
CIVCO	Sterile	Latex Free	CIV-Flex/ Telescopically Folded	610-637	8,9 x 91,5cm

Manufacturer	Sterility	Latex/ Latex Free	Description	Product Number	Dimensions
CIVCO	Sterile	Latex Free	CIV-Flex/ Telescopically Folded	610-1000	10.2 x 147cm
CIVCO	Sterile	Latex Free	CIV-Flex/ Flat Folded	610-001	8.9 x 61cm
CIVCO	Non-Sterile	Latex Free	CIV- Flex/Flat Folded (3D)	610-362	14 x 61cm

C6-1X



Transducer width 7.89 cm (3.11 in.), cable length 2.1 m (82.7 in.)

Manufacturer	Sterility	Latex/ Latex Free	Description	Product Number	Dimensions
CIVCO	Sterile	Latex Free	CIV-Flex/ Telescopically Folded	610-637	8,9 x 91,5cm
CIVCO	Sterile	Latex Free	CIV-Flex/ Telescopically Folded	610-1000	10.2 x 147cm
CIVCO	Sterile	Latex Free	CIV-Flex/ Telescopically Folded (3D)	610-542	14 x 91.5cm
CIVCO	Non-Sterile	Latex Free	CIV- Flex/Flat Folded (3D)	610-362	14 x 61cm

C9-2X



Transducer width 7.89 cm (3.11 in.), cable length 2.1 m (82.7 in.)

Manufacturer	Sterility	Latex/ Latex Free	Description	Product Number	Dimensions
CIVCO	Sterile	Latex Free	CIV-Flex/ Telescopically Folded	610-637	8,9 x 91,5cm
CIVCO	Sterile	Latex Free	CIV-Flex/ Telescopically Folded	610-1000	10.2 x 147cm
CIVCO	Sterile	Latex Free	CIV-Flex/ Telescopically Folded (3D)	610-542	14 x 91.5cm
CIVCO	Non-Sterile	Latex Free	CIV- Flex/Flat Folded (3D)	610-362	14 x 61cm

E12-3



Transducer width at tip 2.42 cm (0.96 in.), transducer maximum width at handle 4 cm (1.58 in.), cable length 2.1 m (82.7 in.)

Manufacturer	Sterility	Latex/ Latex Free	Description	Product Number	Dimensions
CIVCO	Sterile	Latex Free	CIV-Flex/ Flat Folded	610-006	11.9 tapered to 3.8 x 61cm
CIVCO	Non-sterile	Latex Free	CIV-Flex/ Flat Folded/ No Gel	610-007	11.9 tapered to 3.8 x 61cm
CIVCO	Sterile	Latex	Rolled	610-1199	3,5 x 20cm
CIVCO	Sterile	Latex	Neo-Guard	610-213	2,6 x 30cm

Manufacturer	Sterility	Latex/ Latex Free	Description	Product Number	Dimensions
CIVCO	Sterile	Latex	Rolled/ Individual perforated packets	610-214	3,5 x 20cm
CIVCO	Sterile	Latex Free	Neo-Guard/ Rolled	610-843	2,6 x 30cm

For Brain perioperative application (available only for Europe), the SE12-3 probe must be used with one of these sheaths:

Manufacturer	Sterility	Latex/ Latex Free	Description	Product Number	Dimensions
CIVCO	Sterile	Latex Free	Non- Pyrogenic CIV-Flex intraoperative	610-956	4.1 x 147 cm
CIVCO	Sterile	Latex Free	Non- Pyrogenic CIV-Flex intraoperative	610-1107	10.2 x 147 cm
CIVCO	Sterile	Latex Free	Non- Pyrogenic NeoGuard intraoperative	610-1118	15.2 x 244 cm

LV16-5



Transducer width 6.4cm (2.52 in.), cable length 2.1 m (82.7 in.)

Manufacturer	Sterility	Latex/ Latex Free	Description	Product Number	Dimensions
CIVCO	Sterile	Latex Free	Surgi Intraoperative/ Accordion	610-023	15,2 tapered to 7,6 x 244cm

Manufacturer	Sterility	Latex/ Latex Free	Description	Product Number	Dimensions
			Folded/ No Gel		
CIVCO	Sterile	Ultra-Pro II Disposable Replacement Kit	CIV-Flex/ Telescopically Folded (3D)	610-608	14 x 91,5cm

LH20-6



Transducer width 3.2 cm (1.25 in.), cable length 2.1 m (82.7 in.)

Manufacturer	Sterility	Latex/ Latex Free	Description	Product Number	Dimensions
CIVCO	Sterile	Latex Free	Poly telescopically- folded/ attached form- fitting tip	610-797	15,2 x 244cm
CIVCO	Sterile	Latex Free	Non- pyrogenic/ CIV-Flex/ Telescopically- folded with bands	610-956	7,6 tapered to 4,1 x 147 cm

L10-2



Transducer width 5.92 cm (2.33 in.), cable length 2.1 m (82.7 in.)

Manufacturer	Sterility	Latex/ Latex Free	Description	Product Number	Dimensions
CIVCO	Sterile	Latex Free	CIV-Flex/ Flat Folded	610-323	6 x 91.5cm
CIVCO	Sterile	Latex Free	CIV-Flex/ Flat Folded	610-001	8,9 x 61cm

P5-1X



Transducer width at tip 2.89 cm (1.13 in.), transducer maximum width at handle 3.79 cm (1.49 in.), cable length 2.1 m (82.7 in.)

Manufacturer	Sterility	Latex/ Latex Free	Description	Product Number	Dimensions
CIVCO	Sterile	Latex Free	CIV-Flex/ Flat Folded	610-323	6 x 91.5cm

MC12-3



Transducer width at tip 0.91 cm (0.36 in.), transducer maximum width at handle 2.78 cm (1.09 in.), cable length 2.1 m (82.7 in.)

Manufacturer	Sterility	Latex/ Latex Free	Description	Product Number	Dimensions
CIVCO	Sterile	Latex	Latex Pro/ Rolled	610-213	2,6 x 30cm
CIVCO	Sterile	Latex Free	Neo-Guard/ Rolled	610-1126	2 x 30cm
CIVCO	Non-sterile	Latex Free	Neo-Guard/ Rolled	610-838	4 x 30cm

All are CE approved as CE 0120. All are FDA approved:

- General purpose CIV-Flex Latex Free covers are under FDA K970513
- CIV-Flex 3D covers are under FDA K002546
- Neo-Guard, and Eclipse covers are under FDA K991236
- General Purpose Latex covers are under FDA K970515



LATEX TRANSDUCER SHEATHS

Transducers may be sheathed in latex or latex-free sheaths for semi-critical applications. However, the use of latex sheaths for any procedure may involve the risk of an allergic reaction.

The following medical alert has been reprinted to inform the user of the possible risk of using latex sheaths.

FDA Medical Alert, March 29, 1991, Allergic Reactions to Latex-Containing Medical Devices (FDA MDA91-1)

Because of reports of severe allergic reactions to medical devices containing latex (natural rubber), the FDA is advising health care professionals to identify their latex sensitive patients and be prepared to treat allergic reactions promptly.

Patient reactions to latex have ranged from contact urticaria to systemic anaphylaxis.

Latex is a component of many medical devices, including surgical and examination gloves, catheters, intubation tubes, anesthesia masks, and dental dams.

Reports to the FDA of allergic reactions to latex-containing medical devices have increased lately.

One brand of latex cuffed enema tips was recently recalled after several patients died as a result of anaphylactoid reactions during barium enema procedures.

More reports of latex sensitivity have also been found in the medical literature.

Repeated exposure to latex both in medical devices and in other consumer products may be part of the reason that the prevalence of latex sensitivity appears to be increasing.

For example, it has been reported that 6% to 7% of surgical personnel and 18% to 40% of spina bifida patients are latex sensitive.

Proteins in the latex itself appear to be the primary source of the allergic reactions.

Although it is not known how much protein is likely to cause severe reactions, the FDA is working with manufacturers of latex- containing medical devices to make protein levels in their products as low as possible.

FDA's recommendations to health professionals in regard to this problem are as follows:

When taking general histories of patients, include questions about latex sensitivity.

For surgical and radiology patients, spina bifida patients and health care workers, this recommendation is especially important.

Questions about itching, rash or wheezing after wearing latex gloves or inflating a toy balloon may be useful.

Patients with positive histories should have their charts flagged.

If latex sensitivity is suspected, consider using devices made with alternative materials, such as plastic. For example, a health professional could wear a non-latex glove over the latex glove if the patient is sensitive.

If both the health professional and the patient are sensitive, a latex middle glove could be used. (Latex gloves labeled "Hypoallergenic" may not always prevent adverse reactions.)

Whenever latex-containing medical devices are used, especially when the latex comes in contact with mucous membranes, be alert to the possibility of an allergic reaction.

If an allergic reaction does occur and latex is suspected, advise the patient of a possible latex sensitivity and consider an immunologic evaluation.

Advise the patient to tell health professionals and emergency personnel about any known latex sensitivity before undergoing medical procedures.

Consider advising patients with severe latex sensitivity to wear a medical identification bracelet.

The FDA is asking health professionals to report incidents of adverse reactions to latex or other materials used in medical devices. (See the October 1990 FDA Drug Bulletin)

To report an incident, call the FDA Problem Reporting Program, operating through the U.S. Pharmacopeia toll-free number: 800-638-6725.

For questions about FDA activity related to latex sensitivity and anesthesiology, call the Office of Health Affairs, Center for Devices and Radiological Health, Rockville MD.

For a single copy of a reference list on latex sensitivity, write to: LATEX, FDA, HFZ-220, Rockville, MD 20857.

Cleaning Solutions

See [Chapter 10, System Care & Maintenance \[409\]](#) for details regarding disinfection and cleaning and associated products.

Printer Paper and Toner

See [Chapter 10, System Care & Maintenance \[409\]](#) for details regarding changing printer paper and toner and associated products.



CAUTION

Additional equipment connected to medical electrical equipment must comply with the respective IEC or ISO standards (e.g. IEC 60950 for data processing equipment).

Furthermore all configurations shall comply with the requirements for medical electrical systems (see IEC 60601-1).

Any person connecting accessory equipment to medical electrical equipment is configuring a medical system and is therefore responsible that the system(s) complies with the requirements for medical electrical systems.

Attention is drawn to the fact that local laws take priority over the above mentioned requirements. If in doubt, consult your local representative or the technical service department.

Biopsy Guides

Biopsy guides are used during an ultrasound-guided biopsy exam, whose aim is to take a sample of tissue or fluid from a lesion.

The following biopsy kits may be used:

Guides	Manufacturer	Product Number	L18-5	C6-1X	E12-3
Infiniti plus in-plane guidance system	CIVCO	672-001	✓		
Ultra-Pro II needle guidance system	CIVCO	672-002		✓	
Ultra-Pro III needle guide	CIVCO	610-901		✓	
Disposable endocavity needle guide	CIVCO	657-014			✓
Reusable endocavity needle guide	CIVCO	610-666			✓
Disposable sterile endocavity needle guide	CIVCO	610-1275			✓
Disposable sterile endocavity needle guide	PROTEK	Aquamarine #9000			✓

For an exhaustive list, please refer to the last applicable version of suppliers' catalog for SuperSonic Imagine compatible accessories.

3 Safety

Definition of precaution levels

The following symbols are used in this document:















A **WARNING** symbol describes precautions necessary to prevent injury or loss of life.













A **CAUTION** symbol describes precautions necessary to protect the equipment.

Symbols

The following symbols are used on the ultrasound device.

Symbol	Meaning
General Controls	
	On the power switch, represents system power ON and OFF
	On the control panel, represents system ON/Standby
Electricity and Electronics	
	USB input/output port
	Ethernet connection
	Equipotentiality ground
	Isolated patient connection. Type BF
	Earth
	DVI out
Other	
	CE marking of conformity to 93/42/EEC European Directive amended by 2007/47/EEC European Directive
	Assure safe disposal of the device
	ESD sensitive component
	Caution: Read the user's guide
	Warning: Read the user's guide

Symbol	Meaning
	Pinch Point. Keep hands and fingers away.
	Do not push or pull the system from the side or from the monitor, or against an excessive resistance. The system could tip over.
	Do not sit on the system, including printer covers, control panel, or handles
	Manufacturer - Manufacturing date
	Humidity limitation Indicates the range of humidity to which the medical device can be safely exposed.
	Atmospheric pressure limitation Indicates the range of atmospheric pressure to which the medical device can be safely exposed.
	Temperature limitation Indicates the range of temperature to which the medical device can be safely exposed.
	Defibrillation-proof type CF applied part
	Isolated port Indicates both ethernet and USB isolated ports.
	ECG Port
	Probe connector Indicates the state of the probe connector lock.

General equipment safety

Read the User's Guide carefully and get acquainted with the transducers and the ultrasound system before using them.



WARNING

Do not remove system covers. Hazardous voltages are present inside the system.

To avoid electrical shock, use only the supplied power cords and connect to properly grounded wall receptacles.

Do not operate the system in the presence of flammable anesthetics. Explosion can result.

Never operate the system if a significant quantity (2 mL or greater, wet to the touch) of liquid (gel, water, saline, alcohol, blood, etc.) has penetrated the outer casing, including control panel. Discontinue use of the device until the liquid is removed or completely dried.

Exercise caution when negotiating ramps and narrow hallways.

Keep hands and feet away from system wheels when moving or transporting the system.

Before performing maintenance or cleaning, always press the On/Standby switch to put the system into standby mode, set the power switch to Off, and then disconnect the system from the wall outlet.

Do not push the system from the side, or against an excessive resistance. The system could tip over.



CAUTION

Repairs must be performed by authorized personnel only.

Repairs and maintenance performed by unauthorized parties are at the user's risk, and shall void all warranties, explicit or implied. For optimal

performance, the Aixplorer® Mach 30 system should be connected to an electrical circuit that is able to sustain at least 500W.

To avoid interference, avoid operating the system in an environment where portable and mobile radio-frequency (RF) communications are in use.

Avoid handling fluids near the system. Fluids leaking through the air vents of the system may cause electrical failure.

Warm air will be exhausted from the rear, the sides and the bottom of the system. This is normal behavior when the system is in operation. Do not block or obstruct air vents at the rear of the system.

Use the handle to move the system.

To prevent damage to system cables or transducer cables, be careful not to run over them with the machine.

Never attempt to open system covers, transducers or transducer connectors.

Do not submerge the system cables or the transducer cables in liquid.

Ultrasound transducers are easily damaged when handled improperly. Avoid dropping the transducer or bringing it into contact with any sharp or abrasive surfaces or objects.

Improper cleaning or sterilization of the transducers may cause permanent damage. See [Chapter 10, System Care & Maintenance \[409\]](#).

The automatic Freeze feature will turn Off the acoustic output to the transducer when the system is not in use. This will help prevent heat build-up and damage to the transducer.

If an error message appears on the monitor indicating a hazardous condition, note the error code and turn Off the power to the system. Contact the SuperSonic Imagine Customer Service Department to relate and troubleshoot the problem.

Do not load the system with any peripheral devices or equipment weighing more than 26 kg (57 lbs), including probe weight. Doing so may cause the system to become unstable and tip over.

If an excessive internal temperature is reached, the system displays a warning message and will eventually automatically shut down for 30 minutes to prevent over-heating damage.

Electrical safety

This device has been tested by a third-party testing agency and is described as a Class 1 electrical device with Type BF isolated patient applied parts.

This device has demonstrated conformance to the following standards:

- IEC 60601-1, UL 60601-1, CAN/CSA-C22.2 No. 601.1

Shock hazards may exist if this system is not properly grounded. The system must be plugged into a fixed power socket that is grounded. The grounding wire must not be defective. Never use an adaptor or converter to connect with a power source plug (three- prong to two- prong converter).



CAUTION

Use only the cables provided by SuperSonic Imagine and connect these cables according to the installation process.

To avoid electrical shock and fire hazard, check power cables and plugs for damage on a regular basis.



WARNING

All patient-contact devices, such as transducers, and ECG leads not specifically indicated as defibrillation-proof must be removed from patient contact before application of a high-voltage defibrillation pulse.

Hazardous voltages exist inside the system; therefore, the protective covers on the system should not be removed. Any internal adjustment or replacement must be made by an authorized SuperSonic Imagine service representative.

Servicing the power supply : the system must be unplugged for a minimum of two minutes before accessing the live parts of the power supply.

To avoid risk of electrical shock hazards, always inspect the transducer before use. Make sure the face is not cracked, torn or chipped and that the housing of the transducer or the cord is not damaged before use. Diagnostic can be made for you to identify whether a problem comes directly from a transducer or from your Aixplorer® Mach 30 system. Please contact your Customer Service representative.

Ethernet connectors must only be connected to IEC certified equipment. Any USB device may be connected to the system as long as it is self-powered.

Use caution when plugging in or unplugging the system.

Do not touch transducer connector pins when plugging in or unplugging a transducer.

Do not insert any objects through openings in the system covers.

If a foreign object should fall into an opening in the system cover, immediately power down the system and discontinue use until the system can be inspected by an authorized service representative.

Electromagnetic Interference

General information

Electrostatic discharge (ESD) or static shock is a natural phenomenon. Static shock is a discharge of electrical energy that can be transferred to file cabinets, computer equipment, metal door knobs and other individuals. Static shock occurs most often during low humidity conditions that can be brought on by heating or air conditioning. To avoid damage to the system or transducers resulting from an electrical energy discharge from a system user or patient, the use of anti-static mats, anti-static sprays or a ground wire connection between the system and the patient table are recommended. Medical electrical equipments

need special precautions regarding EMC and need to be installed and put into service according to the EMC information. The Aixplorer® Mach 30 system must be installed only by SuperSonic Imagine authorized personnel. This equipment has been tested and found to comply within the limits for medical devices in IEC 60601-1-2 Class B. These limits are designed to provide reasonable protection against harmful interference in a typical medical institution. This equipment can radiate radio frequency energy, and if not installed and used in accordance with the instructions, may interfere with other devices in the vicinity. Powering the system Off and On can determine if the problem is caused by this unit. In addition, electromagnetic fields from fixed transmitters such as base stations for radio (cellular/cordless) telephones and land mobile radios, amateur radio, AM and FM radio broadcast, and TV broadcast may interfere with the use of this device. Portable and mobile RF communications equipment can affect the device. These fields may cause degradation of the image quality of the device. Sources of electromagnetic interference cannot be predicted theoretically with accuracy.

If this system causes harmful interference to other devices, or the system demonstrates an interference pattern on the image, the user is encouraged to try to correct the interference by:

- Increasing the distance separating the pieces of equipment
- Ensuring the system is not connected to the same outlet as the other device(s)
- Using only shielded cabling when connecting the device to networks and peripherals
- Reorienting the device
- Consulting the manufacturer or field service representative for help

If abnormal performance persists, additional measures may be necessary, such as relocating the system.

Recommended separation distances between portable and mobile RF communications equipment and Aixplorer® Mach 30

The Aixplorer® Mach 30 is intended for use in an electromagnetic environment in which radiated RF disturbances are controlled. The customer or the user of the Aixplorer® Mach 30 can help prevent electromagnetic interference by maintaining a minimum distance between portable and mobile RF communications equipment (transmitters) and the Aixplorer® Mach 30 as recommended below, according to the maximum output power of the communications equipment.

Rated maximum output power of transmitter w	Separation distance according to frequency of transmitter		
	150 kHz to 80 MHz $d = 35\sqrt{P}$	80 MHz to 800 MHz $d = 1.2\sqrt{P}$	800 MHz to 2.5 GHz $d = 2.3\sqrt{P}$
0.01	35	0.12	0.23
0.1	11	0.40	0.73
1	35	1.2	2.3
10	111	3.8	7.3
100	350	12	23

For transmitters rated at a maximum output power not listed above, the recommended separation distance (d) in meters (m) can be estimated using the equation applicable to the frequency of the transmitter, where P is the maximum output power rating of the transmitter in watts (W) according to the transmitter manufacturer.

NOTE 1 At 80 MHz and 800 MHz, the separation distance for the higher frequency range applies

NOTE 2 These guidelines may not apply in all situations. Electromagnetic propagation is affected by absorption and reflection from structures, objects, and people.



WARNING

This equipment/system is intended for use by healthcare professionals only. This equipment/system may cause radio interference or may disrupt the operation of nearby equipment.

It may be necessary to take mitigation measures, such as re-orienting or relocating Aixplorer® Mach 30 or shielding the location.



CAUTION

Use of this system in the presence of an electromagnetic field can cause the equipment to perform outside of the published performances.

Avoid using cellular phones, pagers, radios, TVs, or microwave transmission equipment near the machine.

The use of cables, transducers, and accessories other than those supplied with the product may result in increased emissions from the system.

Do not connect transducers to the system unless ESD precautionary procedures are used.

Aixplorer® Mach 30 is provided with the following cables:

Cable type	Length
Power supply cable	3m
Probe cables	2.10m
Ethernet cable	5m

Aixplorer® Mach 30 has been EMC tested with the following accessories:

- SONY UP-D898DC Black and white printer (integrated)
- SuperSonic Imagine L18-5 probe
- SuperSonic Imagine C6-1X probe
- SuperSonic Imagine E12-3 probe

- SuperSonic Imagine LV16-5 probe
- SuperSonic Imagine L10-2 probe
- SuperSonic Imagine LH20-6 probe
- SuperSonic Imagine MC12-3 probe
- SuperSonic Imagine P5-1X probe
- SuperSonic Imagine C9-2X probe
- JADAK Flexpoint HS-1M Barcode Scanner
- Ethernet cable, CAT6a SSTP (PIMF) 500Mhz (shielded) AWG26/7, meets standards EIA/TIA 568 B2- ISO/IEC11801, maximum length 5 meters
- Two-pedal Savant Elite 2 Foot switch by KINESIS



WARNING

Using accessories and cables other than those listed above may result in increased emissions or decreased immunity of the system.

Declaration of electromagnetic emissions

Aixplorer® Mach 30 is suitable for use in the following environment. The user must assure that it is used only in the electromagnetic environment as specified.

Emission test	Compliance	Electromagnetic environment - guidance
RF Emission CISPR 11	Group 1	Aixplorer® Mach 30 uses RF energy only for its internal function. Therefore, its RF emissions are very low and are not likely to cause any interference in nearby electronic equipment.
RF Emission CISPR 11	Class B	Aixplorer® Mach 30 is suitable for use in all establishments other than domestic and those directly connected to the public low-voltage power supply network that supplies buildings used for domestic purposes.
Harmonic emission IEC 61000-3-2	Class B	
Voltage fluctuation/Flicker emissions IEC 61000-3-3	Complies	



WARNING

Aixplorer® Mach 30 with its peripherals should not be used adjacent to or stacked with other electrical equipment.

If the use of adjacent or stacked electrical equipment is necessary, verify the normal operation of Aixplorer® Mach 30 and its peripherals.

Declaration of immunity

Guidance and manufacturer's declaration - electromagnetic immunity			
Aixplorer® Mach 30 is suitable for use in the following environment. The user must assure that the system is used according to the specified guidance and only in the electromagnetic environment listed in the electromagnetic environment as specified.			
Immunity Test	IEC 60601 Test	Compliance Level	Electromagnetic Environment Guidance
Conducted RF IEC 61000-4-6 Radiated RF IEC 61000-4-3	3 Vrms 150 kHz to 80 MHz 3 V/m 80 MHz to 2,5 GHz	0.10 Vrms 3.0 V/m	<p>Potable and mobile RF communications equipment should be used no closer to any part of Aixplorer® Mach 30, including cables, than the recommended separation distance calculated from the equation applicable to the frequency of the transmitter.</p> <p>Recommended separation distance</p> $d = 35\sqrt{P}$ $d = 1.2\sqrt{P} \text{ 80 MHz to 800 MHz}$ $d = 2.3\sqrt{P} \text{ 800 MHz to 2.5 GHz}$ <p>Where P is the maximum output power rating of the transmitter in watts (W) according to the transmitter manufacturer and d is the recommended separation distance in meters (m).</p> <p>Interference may occur in the vicinity of equipment marked with the following symbol:</p> 

NOTE 1 At 80 MHz and 800 MHz, the higher frequency range applies

NOTE 2 These guidelines may not apply in all situations. Electromagnetic propagation is affected by absorption and reflection from structures, objects and people.

a) Field strengths from fixed transmitters, such as base stations for radio (cellular/cordless) telephones and land mobile radios, amateur radio, AM and FM radio broadcast and TV broadcast cannot be predicted theoretically with accuracy. To assess the electromagnetic environment due to fixed RF transmitters, an electromagnetic site survey should be considered. If the measured field strength in the location

in which Aixplorer® Mach 30 is used exceeds the applicable RF compliance level above, Aixplorer® Mach 30 should be observed to verify normal operation. If abnormal performance is observed, additional measures may be necessary, such as re-orienting or relocating the Aixplorer® Mach 30.

b) Over the frequency range 150 kHz to 80 MHz, field strengths should be less than [VI] V/m.

Immunity test	IEC 60601 test level	Compliance level	Electromagnetic environment guidance
Electrostatic discharge (ESD) IEC 61000-4-2	±8 kV contact ±15 kV air	± 4 kV contact ± 8 kV air	Floors shall be wood, concrete or ceramic tile. If floors are covered with synthetic material, the relative humidity shall be at least 30 %
Electrical fast transient/burst IEC 61000-4-4	±2 kV for power supply line ±1 kV for input/output lines	±2 kV for power supply line ±1 kV for input/output lines	Main power quality shall be that of a typical commercial or hospital environment.
Surge IEC 61000-4-5	±1 kV differential mode ±2 kV common mode	±1 kV differential mode ±2 kV common mode	Main power quality should be that of a typical commercial or hospital environment.
Voltage dips, short interruptions and voltage variations on power supply input line IEC 61000-4-11	<5 % UT (>95% dip in UT) for 0.5 cycle 40 % UT (60% dip in UT) for 5 cycles 70 % UT (30% dip in UT) for 25 cycles <5 % UT (>95 % dip in UT) for 5 sec	<5 % UT (>95% dip in UT) for 0.5 cycle 40 % UT (60% dip in UT) for 5 cycles 70 % UT (30% dip in UT) for 25 cycles <5 % UT (>95 % dip in UT) for 5 sec	Main power quality should be that of a typical commercial or hospital environment. If the user of the Aixplorer® Mach 30 requires continued operation during power mains interruptions, it is recommended that the Aixplorer® Mach 30 be
NOTE : UT is the a.c. main voltage prior to application of the test level.			

Immunity test	IEC 60601 test level	Compliance level	Electromagnetic environment guidance
			powered from an uninterruptible power supply.
Power frequency (50/60Hz) Magnetic field IEC 61000-4-8	3 A/m	3 A/m	Power frequency magnetic fields should be at levels characteristic of a typical location in a typical commercial or hospital environment.
NOTE : UT is the a.c. main voltage prior to application of the test level.			

Thermal Safety

Our device has been designed to have a surface temperature not exceeding 50°C in air and 43°C when in contact with the patient or user when measured under the requirements of the IEC 60601-2-37 standard. Some heat is generated by the ultrasound system, and by the transducer. Heat generated by the electrical components of the ultrasound system is dissipated through specific outlets.

Heat may also be generated at the surface of the ultrasound transducer. In some cases the heat of the transducer may be detected at the surface of the skin. This would occur if the transducer remains in contact with a part of the body for a prolonged period of time.

The ultrasound system has been equipped with internal sensors which monitor the temperature rise within the chassis. Alerts and WARNING messages may be displayed on the system in the event of an overheating condition. In the case of extreme or prolonged heat build-up, the system may automatically shut-down.

If heating of either the transducer or system is determined to be a problem, please call your SuperSonic Imagine service representative immediately.



WARNING

Ultrasound system overheating may occur if the environment exceeds the recommended ambient operating conditions. To avoid overheating, be sure the system is operated under normal “room temperature” conditions, and adequate ventilation is provided.

Ultrasound can produce harmful effects in tissue and potentially result in patient injury. Always minimize exposure time and keep ultrasound levels low when there is no medical benefit (ALARA principle).

A system which is overheating due to external conditions or an internal fault may issue a warning followed by a spontaneous shut-down to prevent heat damage or fire. If this occurs, discontinue use of the system and call your SuperSonic Imagine service representative.

Transducer surfaces may experience heat-build up. This is especially true if the transducer is in prolonged use and/or the point of contact with the body is stationary. Please use ALARA principles to prevent unnecessary heating of the patient or the transducer.

Using the “Freeze” control is recommended to suspend acoustic energy to the transducer when not in use.

Do not maintain the transducer in one position on the body for prolonged periods of time. Prolonged exposure can produce minor burns.



CAUTION

Do not operate the system if ambient temperature is above the recommended limit.

Use caution when operating the system in small spaces. Ambient room temperature increases may occur.

Change or clean air filters regularly to prevent system overheating.

The ultrasound system is designed to auto-Freeze if the imaging controls are not changed for a duration defined by the user. This is designed to

reduce heat build-up of the transducer. Use the Freeze button to resume scanning.

If a system persistently issues an operating temperature-related warning, discontinue use of the system and call your SuperSonic Imagine service representative.

If the system reaches a certain temperature, follow the instructions that appear on the screen.

Mechanical Safety

The ultrasound system has been ergonomically and mechanically optimized to be pleasant, efficient and safe, provided that it is used as intended and all instructions, warnings and cautions specified in this Guide are followed. If the system suffers mechanical damage, discontinue use and call an authorized SuperSonic Imagine representative for assistance.



WARNING

Never use the system if any of the exterior covers are cracked, damaged, missing or improperly installed.

Touching internal electrical or mechanical parts may cause injury or death.

If a foreign object should fall into an opening in the system cover, immediately power down the system and discontinue use until the system can be inspected by an authorized service representative.

Do not push or pull the system from the side or from the monitor, or against an excessive resistance. The system could tip over.



CAUTION

Use caution when accessing the peripheral bays.

Use caution when accessing cables on the back of the system. Some mechanical exterior parts may cause abrasion.

If the system does not roll smoothly on its wheels, do not force the system to move.

Do not overload the system with heavy peripheral devices or equipment. Doing so may cause the system to become unstable and tip over.

To prevent damage to system cables or transducer cables, be careful not to run over them with the machine.

Never attempt to open a transducer or a transducer connector.

Do not submerge the system cables or the transducer cables in liquid.

Safely performing ultrasound examinations with the SuperSonic Imagine Aixplorer® Mach 30 system

Bioeffects and biophysics of ultrasound interactions

Frequencies and energy levels of ultrasound waves

Ultrasound is sound at a very high frequency above human hearing, i.e. above 20 kiloHertz (kHz). For medical diagnostic purposes, ultrasound systems generate ultrasound waves typically ranging from 1 to 20

MegaHertz (MHz). A probe, or transducer, is applied on the patient's body. It emits ultrasound waves that pass into the body, then reflect off the different tissue boundaries. The transducer then receives these reflections, which are assembled and processed by a computer system to generate a picture displayed on a video monitor. Key parameters of the ultrasound waves can vary, such as their frequency, density, focusing and aperture. For example, beams at higher frequencies produce higher resolution images but cannot penetrate as deeply into the body as lower frequencies, which penetrate more deeply but show lower resolution. Therefore, the choice of frequency is a trade-off between spatial resolution of the image and imaging depth. Energy levels of ultrasound waves are measured in W/cm^2 . The two typical values that are calculated and taken into account are the spatial-peak temporal average intensity (I_{SPTA}), measured in mW/cm^2 and of the spatial-peak pulse average intensity (I_{SPPA}), measured in W/cm^2 . Diagnostic ultrasound systems usually use energy levels corresponding to an ranging between 0 and 720 mW/cm^2 .

Change in policy and operator education

The first guidelines and recommendations ever published for ultrasound manufacturers was proposed by the American Institute of Ultrasound in Medicine (AIUM) in 1983. These guidelines were revised in 1988 where the energy maximum limit was fixed to 100 mW/cm^2 . Below this limit, no adverse bioeffects had ever been reported on animals or patients, although contradictory observations have been reported later, in 1993. Since 1993, the Food and Drug Administration (FDA) imposed a maximum limit on the acoustic output of ultrasound devices. However, due to the continuous development of sophisticated systems with improved image quality and diagnostic sensitivity, it was realized that safely increasing the limit under specific circumstances could bring diagnostic advantages (i.e., patients with fatty tissues). In 1997, the FDA increased the maximum limit of energy output level up to a much higher value (see section Present state of output levels) and recognized an increased role of the operator in limiting the potential for ultrasound bioeffects. In conclusion the operator has the responsibility of making an informed decision concerning the desired diagnostic information in comparison to possible adverse bioeffects. Achieving this goal requires an adapted education that needs to be provided to every operator in order to make an informed

and balanced decision. In this context, the AIUM document published in 1994, "Medical Ultrasound Safety", is highly recommended, as is this particular educational content.

Ultrasound use: history and safety record

Ultrasound really started to be used in clinical medicine in the 1950's. It has always been considered as a potential medical imaging technique despite continuing concerns of potential related risks: from the beginning, some studies demonstrated that sufficient ultrasound levels could harm biological material, even with lower doses than used today. Due to the absence of adverse effects reported on patients, the diagnostic ultrasound technology kept on being developed and improved, culminating in the mid-1980's with grayscale and real-time imaging modes. In parallel, the ability to quantify ultrasonic fields also improved considerably, thus giving a tool to measure accurately ultrasound energy levels. Diagnostic ultrasound imaging has accumulated an excellent safety record over the past 50 years. The recent development of new applications and new modes and the increase in ultrasound use have not impacted on this safety record. However, ultrasound safety continues to be discussed and regulatory authorities are continuously revising the guidelines and standards in order to minimize potential risks and maintain a safe framework for patients, manufacturers and users.

Potential hazards at high output levels

The first deleterious effects of ultrasound were observed by Paul Langevin in 1917: "fishes placed in the beam in the neighborhood of the source operation in a small tank were killed immediately, and certain observers experienced a painful sensation on plunging the hand in this region". In 1930, Harvey released the first review paper on biological effects of ultrasound: he reported on the physical, chemical, and biological effects in which alterations were produced in macromolecules, micro-organisms, cells, isolated cells, bacteria, tissues, and organs with a view towards the identification of the interaction mechanisms. In the mid 1990's, an animal study observed lung and intestine hemorrhage with a pulsed, 2 MHz ultrasound exposure for 3 minutes, although this observation was not confirmed intraoperatively

with transesophageal echocardiography. Here are some examples of possible deleterious bioeffects of ultrasound:

- Cells of the sensory organs (eye, ear, nervous tissue) are particularly sensitive to ultrasound and can be destroyed by thermal effect.
- Cavitation mechanisms can create tearing lesions of the inner layer of blood vessels, thus leading to thrombogenic processes.
- Cell lysis has been observed in vitro with 1 MHz continuous ultrasound exposure, due to cavitation.
- Cardiac premature contractions have been observed in frogs with 1.2 MHz exposure to a single 5-millisecond pulse with normal recovery.
- The development of blood cells has been reported to be altered in monkeys after multiple exposures to ultrasound at diagnostic levels.

Moreover, potential bioeffects of ultrasound at the subcellular level may lead to structural and functional changes in cell membranes, thus affecting signal transduction, for example.

Mechanisms for thermal and non-thermal bioeffects

Ultrasound can cause heating of the tissues (thermal effect) and can create non-thermal effects (mechanical effects).

THERMAL EFFECTS

An ultrasonic wave propagating into a biological tissue is attenuated with distance from its emission source, due to scattering (redirection of the ultrasound beam) and/or absorption (conversion into heat). Depending on the tissue characteristics, a temperature increase will occur if the rate of heating is greater than the rate of cooling the tissue. Operators must be aware of that risk, which may counterbalance the benefits of ultrasound examination.

NON-THERMAL OR MECHANICAL EFFECTS

Non-thermal effects include cavitation, production of audible sounds, movement of cells in liquid, electrical changes in cell membranes,

shrinking and expansion of bubbles in liquid, and pressure changes. Cavitation has been extensively studied: it happens when bubbles located in an ultrasound field start to resonate. This effect has not been demonstrated in human tissue; some observations of haemorrhagia have only been made in lung or intestine of laboratory animals. Other non-thermal effects caused by ultrasound include changes in pressure, force, torque (causing tissues to rotate) and streaming. Audible sounds and electrical changes of cell membranes can derive from such changes, potentially causing cell damage. Consequences of non-thermal bioeffects can cause damage to the tissue, eventually cell death, cell membrane disruption or ruptures of small blood vessels. Although these bioeffects have not been observed in humans, they could potentially occur with future technology.

EXPOSURE-EFFECT STUDIES

The bioeffects of ultrasound on fetuses have always been of concern, due to the presence of developing tissues. This has become even more present due to new ultrasound modalities arising in the late 1980's (harmonic imaging, color Doppler and 3D imaging) that have allowed new diagnostic capabilities. Since these methods potentially required more ultrasound energy, the FDA revised its diagnostic ultrasound regulatory guidelines in the early 1990's. As a result, the upper limit of output intensity allowed in fetal examinations has been raised more than 7 times its original value. Some concerns have arisen about the new regulations and researchers conducted epidemiological studies looking for associations between ultrasound exposure and newborn defects linked to fetal development. As reviewed by the National Council on Radiation Protection and Measurements (NCRP), one of the largest studies followed 15,000 women in Australia, but was not designed to study birth defects. Therefore, the lack of increase in birth defects was reassuring but not conclusive. Another large Canadian study focused on the correlation between ultrasound screening and prematurity. It concluded that the group receiving more ultrasound scans during pregnancy had slightly lower birth weights. The interpretation of epidemiological studies, however, can be biased by the prescription of ultrasound due to a suspected fetal problem. Additionally, the NCRP has stated that there is insufficient evidence to conclude that diagnostic ultrasound is the cause of adverse effects such as low birth weight, or any adverse effect whatsoever. However, this conclusion does not preclude the possibility of any effect. Research is limited because physicians

cannot perform more stringent experiments on their patients. As a preliminary mandatory step, more animal studies are recommended by the NCRP.

Risk versus benefit

Diagnostic ultrasound systems provide diagnostic information that creates a clear benefit to the patient, to the physician, and to healthcare systems. Currently available systems give very good quality images and highly relevant information that allow physicians to make optimal decisions. Ultrasound imaging is a favorite imaging technique because:

- It appears to be safe,
- It is known to provide diagnostic information with great sensitivity and specificity,
- It is widely accepted by patients,
- It has low costs when compared to other radiological modalities.

However, there are risks in doing or not doing an ultrasound exam: On the one hand, performing an ultrasound examination may expose the patient to potential adverse bioeffects by heating or cavitation, although no such incidents have ever been reported on humans at diagnostic ultrasound levels. Physicians must also weigh the expected benefit against the potential risks of the ultrasound exam. They must balance the intensity and energy that is used to perform the exam against the beneficial information it brings. Increasing the intensity, the exposure time, focal properties, and the pressure are associated with an increased risk of bioeffects. However, using a low intensity may lead to poor diagnostic information. On the other hand, not doing an ultrasound examination may prevent physicians and patients from getting relevant diagnostic information, or may lead to the acquisition of the same information through other modalities, which may be more invasive or require exposure to ionizing radiation. There currently should be no hesitation when choosing to perform an ultrasound examination when a significant clinical benefit is expected. For example, cardiac ultrasound examinations with transesophageal echocardiography give the ability to image the structure and function of the heart and great vessels, and allow the operator to follow the course of blood flow within the heart. In obstetrics, the National Institute of Health consensus development conference held in the early 1980's recommended not to perform

routine ultrasound examination, but identified a number of appropriate clinical indications for the use of ultrasound imaging during pregnancy. "Diagnostic ultrasound has been in use since the late 1950s. Given its known benefits and recognized efficacy for medical diagnosis, including use during human pregnancy, the American Institute of Ultrasound in Medicine herein addresses the clinical safety of such use: No confirmed biological effects on patients or instrument operators caused by exposure at intensities typical of present diagnostic ultrasound instruments have ever been reported. Although the possibility exists that such biological effects may be identified in the future, current data indicate that the benefits to patients of the prudent use of diagnostic ultrasound outweigh the risks, if any, that may be present."

PRESENT STATE OF OUTPUT LEVELS

Since the adoption of the Output Display Standard (ODS) in 1992 and the publication of the revised FDA guidelines in September 1997, diagnostic ultrasound systems that follow the Output Display Standard, including fetal Doppler applications (except fetal heart rate monitors), must have a maximum energy level that is not application-specific. Therefore, the maximum energy level is currently defined by (1) a derated limit of 720 mW/cm² and (2) a maximum MI of 1.9 or a derated of 190 W/cm². The only application-specific exception to these guidelines is the ophthalmic use with lower maximum values. When compared to the maximum application-specific limits that were decided and published in 1985 and 1987 as shown in the tables below, the actual maximum values available on today's systems have become much higher.

Table 3.1. FDA's pre-amendments levels of diagnostic ultrasound devices (FDA, 1985)

	Derated intensity values		
	$I_{SPTA}(\text{mW}/\text{cm}^2)$	$I_{SPPA}(\text{W}/\text{cm}^2)$	$I_m(\text{mW}/\text{cm}^2)$
Cardiac	430	65	160
Peripheral vessel	720	65	160
Ophthalmic	17	28	50
Fetal imaging and other ^a	46	65	160

^aAbdominal, Intraoperative, Small Organ (breast, thyroid, testes), Neonatal Cephalic, Adult Cephalic

Table 3.2. FDA's pre-amendments levels of diagnostic ultrasound devices (FDA, 1987)

	Derated intensity values		
	$I_{SPTA}(\text{mW}/\text{cm}^2)$	$I_{SPPA}(\text{W}/\text{cm}^2)$	$I_m(\text{mW}/\text{cm}^2)$
Cardiac	430	190	310
Peripheral vessel	720	190	310
Ophthalmic	17	28	50
Fetal imaging and other ^a	94	190	310

^aAbdominal, Intraoperative, Small Organ (breast, thyroid, testes), Neonatal Cephalic, Adult Cephalic

However, with the publication of the ODS in 1992, the ultrasound users have been given the ability to operate their systems with real-time information on the potential risk of biological effects within the tissue. The real-time information consists of two biophysical indices known as the Thermal Index (potential risk for temperature increase) and the Mechanical Index (potential risk for mechanical tissue damage). This has allowed operators to make appropriate and informed clinical decisions, to weigh risks versus benefits, and to implement the “As Low As Reasonably Achievable” (a.k.a. ALARA) principle.

Proposed indices as indicators of thermal and mechanical effects

THERMAL INDEX

The Thermal Index (TI) estimates the temperature increase within theinsonified tissue; its value derives from the ratio of the total acoustic power to the acoustic power required to raise the tissue temperature by 1°C. Every type of tissue has different absorption characteristics, and therefore a different absorption coefficient, which is directly proportional to the ultrasound wave frequency: the higher the frequency, the greater the absorption and the lower the depth penetration. Thus, optimizing the image penetration should take into account the increased risk

of a temperature rise in the tissue. Because various tissues (blood, amniotic fluid, cerebrospinal fluid, urine, soft tissue, and bone) have different absorption capabilities and coefficients, some devices further subcategorize the TI according to the nature of theinsonified tissue: soft tissue thermal index (TIS) for soft homogeneous tissues, cranial bone thermal index (TIC) for bone at or near the surface, and bone thermal index (TIB) for bone after the beam has passed through soft tissue. Bone has a very high absorption coefficient. Biological liquids such as amniotic fluid, blood, cerebrospinal fluid, and urine have an absorption coefficient of zero and therefore show minimal temperature rise. Soft tissue has an absorption coefficient that falls somewhere between fluid and bone.

MECHANICAL INDEX

The mechanical or non-thermal effects of ultrasound absorption are estimated by a relative measure: the Mechanical Index (MI). It is calculated by dividing the spatial-peak value of the peak rarefractional pressure (rated by 0.3 dB/cm-MHz at each point along the beam axis) by the square root of the center frequency. As described above, the mechanical effects are the result of compression and decompression in the tissue and the formation of microbubbles (cavitation). This phenomenon is related to the peak negative pressure during a pulse, which is related to the pulse-average intensity. Therefore, the spatial-peak pulse-average intensity () is related to cavitation. Many ultrasound products use for specifications and therefore, operator awareness is a necessity. Current standards recommend that if an ultrasound device is capable of achieving a TI or MI of greater than 1.0, then the output display screen must show the appropriate index value for the operator to predict the potential for adverse bioeffects.

Thermal mechanisms

Thermal bioeffects

As introduced in the previous section, the absorption of ultrasound energy by biological tissues can produce heating. The self-heating of the probe may also contribute to heating in tissue. The mechanism of

thermal bioeffects is well understood and can be estimated for different exposure conditions. However, even if some studies in mammalian tissue demonstrate that some aspects of the theory are reasonably well understood, many unanswered concerns still remain in terms of being able to assess in vivo temperature increase. The rate of heat generation per unit volume is directly proportional to:

- the ultrasonic temporal-average intensity, which is itself proportional to the pressure amplitude and inversely proportional to the density of the medium
- the ultrasonic amplitude absorption, which increases with the increasing frequency

If damage occurs during exposure of tissue to elevated temperature, the extent of damage will be dependent upon the duration of the exposure as well as on the temperature increase achieved. Detrimental effects in vitro are generally noted at temperatures of 39–43°C, if maintained for a sufficient time period. At higher temperatures (>44°C) coagulation of proteins can occur. These effects have been documented in experimental studies of heat-induced cell death in cell cultures. Ultrasound machine operators must be particularly aware that risks may offset the benefits of ultrasound exposures when the temperature rise at the focal point of the ultrasound beam is calculated to be, for example in fetus echographic studies, more than 3°C for ten minutes or more. In Aixplorer® Mach 30, the temperature is calculated according to the Standard for real-Time Display of Thermal and Mechanical Acoustic Output Indices on Diagnostic Ultrasound Equipment, NEMA UD3-2004 (refer to the section "Meaning of the TI and MI and Relation with Bioeffects"). However, threshold-based data suggest that for non-fetal soft tissue, and for scanning conditions consistent with conventional B-mode ultrasound exams for which the exposure durations at the same in situ location would be less than a few seconds, the allowable maximum temperature increase could be relaxed relative to longer exposures.

Table 3.3. Temperature thresholds for biological risks on embryonic and adult tissues

Thermal threshold	Temperature (°C)	Biological risk
Physiological level	37.0	safe region
Embryonic tissue	39.5	risks for obstetrics and pediatrics
Adult tissue	41.0	general risks

Tissue factors influencing ultrasound thermal effects

Ultrasonic waves propagating into biological tissues are attenuated due to the properties of the tissue. This attenuation is due to either absorption (portion of the wave energy that is converted into heat) or scattering (portion of the wave energy which changes direction). The higher the absorption, the higher the potential risk of rise of temperature within the tissue. Furthermore, as explained above, tissues with poor vascularization, (eye, tendon, fat) and tissues that conduct the heat (bone), are subject to higher temperature rises.

Technical and exposure factors influencing ultrasound thermal bioeffects

Several technical factors also affect the temperature rise in the insonified tissue:

- Frequency of the ultrasound wave

Tissue heating depends on the absorption of ultrasound; absorption depends on the frequency of the ultrasound wave received. Therefore, heating in tissues will increase as the frequency of the ultrasound wave increases.

- Beam focusing

It improves the image resolution but it also increases the intensity and the potential of a temperature rise.

- Type of ultrasound wave form (pulsed or continuous waveforms)

Pulsed waves usually produce less heat than continuously emitted waves. The spatial-peak temporal-average intensity (ISPTA) is defined as the intensity at the maximum temporal-average intensity. Other factors include pulse duration, pulse repetition frequency and beam/scanning configuration. The duty cycle is the product of the pulse duration and pulse repetition frequency. The heating in tissue is proportional to the duty cycle.

- Exposed tissue volume

Scanned modes (B-mode and color flow Doppler) allow a greater volume of tissue exposed to the ultrasound energy; this decreases the risk of heating. Unscanned modes (M-mode and spectral Doppler) use a stationary beam over a narrower volume of tissue; these modes show a higher risk of heating in tissues. The greatest temperature rise occurs between the focal point and the surface, the exact location of the “hottest point” depending on tissue attenuation, absorption, and the focal depth.

- Duration of ultrasound exposure

Temperature is affected by energy absorption during ultrasound exposure. The longer the tissue is exposed, the greater the absorption, thus the greater the risk for potential heating.

THERMAL DOSE CONCEPT

An immediate consequence of a temperature increase is an increase in biochemical reaction rates. Most enzymes have their biological activity increased by a factor 3 for each 10°C temperature increase. However, they become denatured over 39°C, and deleterious effects are seen in vitro at temperatures ranging from 39 to 43°C, if exposure lasts a sufficient time. The concept of thermal dose describes the dependence between the duration of exposure and the increase of temperature. In biological tissues, the temperature of 43°C has been found to be a transition threshold temperature, which serves as a reference, units of thermal dose being “equivalent minutes at 43°C”. Practically every increase of 1°C above 43°C halves the equivalent time, while every decrease of 1°C below 43°C results in a 4-fold equivalent time.

BIOLOGICALLY SENSITIVE SITES

All biological tissues are sensitive to temperature, which can have deleterious irreversible effects. The fetus and the lens of the eye are two examples of some tissues that are more sensitive. During pregnancy, the fetus can absorb higher temperature elevation than its mother's surrounding tissue. Also, the ongoing ossification that occurs during the first trimester can lead to alteration of brain tissue by heat conduction within the neonatal skull. The 1998 recommendations from the World

Federation of Ultrasound in Medicine and Biology (WFUMB) with regard to ultrasound-induced temperature elevation are as follows:

1. A diagnostic ultrasound exposure that produces a maximum in situ temperature rise of no more than 1.5°C above normal physiological levels (37°C) may be used clinically without reservation on thermal grounds.
2. A diagnostic ultrasound exposure that elevates embryonic and fetal in situ temperature above 41°C (4°C above normal temperature) for 5 min or more should be considered potentially hazardous.
3. The risk of adverse effects is increased with the duration of exposure.

ABSORPTION

The volume rate of heat generation due to absorption is proportional to the acoustic intensity and absorption at a single frequency. After the initial propagation, the heat diffuses slowly into the tissue, expands, smooths out, and diminishes from the original pattern. Tissue properties influence the temperature rise induced by ultrasound energy in the way the absorption of heat is directly affected by the protein proportion tissue contains (collagen has particularly high absorption capabilities). In most of the clinical situations, bone tissues have the greatest absorption coefficient, skin and tendon have intermediate absorption capabilities, brain, liver and kidney have a low absorption and finally, fluids show absorption coefficients close to zero. Absorption properties are known to be dependent on the wave frequency, but it is important to know that amplitude and shape of waveforms also change as they propagate and energy is absorbed into the medium. Absorption in the body is a highly significant effect, especially because it limits the penetration of ultrasound waves in the body, i.e. the maximum depth at which tissues can be imaged. Usually imaging systems have a way of increasing acoustic amplitude as a function of depth to compensate for the absorption phenomenon.

SURROUNDING TISSUE

The actual temperature rise in tissue depends on several factors including the local specific heat capacity, the time of exposure, the rate of temperature rise and the rate of distribution of heat in neighboring tissue.

The measurable parameter for this distribution of heat, known as the perfusion length, depends directly on the thermal conductivity of the tissue and inversely on the blood perfusion flow rate and the specific heat capacity of blood. Perfusion lengths are measured in millimeters and range for different tissues from 1 (for highly vascularized organs) to 20 (for poorly perfused tissue). Blood perfusion plays a significant role in cooling the tissue and must be considered when estimating the tissue temperature and its variations. Tissue with poor vascularization, such as tendon, fat and cornea, and tissue that conduct the heat, such as bone, are subject to higher temperature rises. Where the perfusion length is smaller than any dimension of the insonated volume, heat transfer from surrounding tissue is small. On the contrary, where it is larger than any of the dimensions of the insonated volume, heat transfer within the insonated volume becomes important. Therefore, tissues adjacent to bone are particularly susceptible to heat increase via conduction.

HEAT CONDUCTION EFFECT

Temperature rise by heat conduction refers to the increase of the local temperature of a tissue that is located close to another heating object. When the temperature gets elevated in a bone structure within the body, due to absorption, the surrounding tissue may then be subject to heating by conduction. This phenomenon is of particular concern for brain heating due to the proximity of the skull. It can also happen when a transducer is selected but left unused. Acoustic power may flow to the outer absorbing lens where it causes self-heating. The transducer itself can then heat the body by conduction due to direct contact when the operator starts the exam. However, temperature of the probe surface is controlled not to exceed a few degrees when in air and air-gel mixture. When the transducer is in use, the temperature contribution through conduction is often neglected because it is limited to the surface of the body and it is smaller than the absorption contribution.

SCATTERING

The scattering effect depends on the shape and roughness of the object insonified (scatterer). Three categories can be distinguished, depending on the size of the scatterer.

Specular Scattering

Specular scattering relates to reflections from objects whose shapes are much bigger than a wavelength. If the object's dimensions are larger than the wavelength, the approximation of the reflection on the object forms a wavefront that mimics the shape of the object.

Diffuse Scattering

Diffusive scattering happens for objects that are much smaller than a wavelength. Irregularities on the surface of the object create individual reflections that do not cause any significant interference effects. It has important implications in medical imaging because biological tissue is often considered as aggregates of small sub-wavelength point scatterers. Doppler methods measure blood flow depending on scattering effect by numerous small spatially unresolved blood cells. Most ultrasound contrast agents also act as tracers to enhance the scattering of ultrasound on gas-filled resonant spheres.

Diffractive Scattering

Diffractive scattering occurs on objects slightly less than a wavelength to hundreds of wavelengths. This group of scattering objects is the largest. Scattered waves in this situation can be considered to be originating from the surfaces of the scatterers, which act as secondary ultrasound sources.

Spatial volume of insonified tissue

For a given duration of ultrasound exposure and a given level of acoustic energy delivered, larger volumes of insonated tissue will be submitted to a more diffuse heating, avoiding too high temperatures. At the precise location of ultrasound beam focusing, the temperature will be higher than before or after the focus zone. The aperture of the ultrasound beam also impacts the heating capabilities of the ultrasound beam in the way it

generates a more or less focused ultrasound beam, bringing more or less energy into the tissue. As described above, the scanning mode used can also impact the spatial volume of insonified tissue.

Homogeneity of tissue in insonified volume

The homogeneity of tissue being insonified is a key characteristic in heat transfer. The ultrasound waves must typically pass through the several layers of tissue that form organs. These layers influence the absorption of the ultrasound energy since increased absorption in any given layer decreases the ultrasound energy available at the point of interest. The effect of tissue layering on the biological effects of ultrasound has been extensively studied in obstetrics. They demonstrated that the attenuation model that applies best to real observations is the overlying tissue model, in which attenuation depends upon both frequency and non-fluid distance. Furthermore, they demonstrated that the attenuation coefficient asked by the international standards was 2 to 3 times lower than the measured mean values to estimate ultrasonic intensity quantities in tissue.

Non-thermal mechanisms

In addition to heat, ultrasound waves also have various types of mechanical effects on biological tissue and media, also called non-thermal effects.

Cavitation and role of gas bubbles

CAVITATION

Acoustic cavitation may occur when the ultrasound beam crosses a cavity area, such as a gas pocket. Some adult tissue contains gas bubbles (lung and intestine), and therefore are more vulnerable to cavitation. With acoustic cavitation, pre-existing bubbles are modified or new bubbles are formed, due to both expansion and contraction of the gas body.

The ultrasound waves can lead the bubbles to expand and contract rhythmically, i.e. to pulsate or resonate. The hypothesis of bubbles that would form in tissues and organs that do not contain gases is currently under investigation.

RECTIFIED DIFFUSION

Under ultrasound insonification and certain conditions, a gas bubble can resonate and grow instead of dissolving in the medium liquid. The ultrasound wave makes the bubble expand and outer dissolved gases get pumped in, which increases its size rapidly.

FACTORS GENERATING CAVITATION

The generation of cavitation depends on numerous factors including the ultrasonic pressure, the type of ultrasound wave emitted (focused or not, pulsed or continuous), the presence of standing waves and the nature and state of the material. Cavitation can be prevented by first being aware of whether or not gas bubbles stay in the tissue being imaged. In liquid media, another significant biological factor over cavitation is the density of the liquid: higher density liquids create intense cavitation with a greater implosive force. Some technical factors can also be of great help, including limitation of the pressure amplitude of the ultrasound pulse and length of the pulse. When gas bubbles are present in the tissue, their number, size and location are also significant contributors to the effect.

TYPES OF CAVITATION

Stable cavitation & microstreaming

Stable cavitation refers to the periodic expansion or contraction of a gas bubble. The gaseous body pulsates due to the ultrasound field, and remains stable. Part of the liquid medium surrounding the gaseous bubbles can begin to stream with the oscillations, leading to microstreaming. Theoretically, microstreaming could also be caused by “acoustic streaming” in fluid media, due to the stirring action of the ultrasound wave. As happens in microstreaming, the acoustic streaming

results in a flow of liquid speeding up as the acoustic pressure of the ultrasound increases. This phenomenon could damage cell membranes, which could undergo disruption. However, the real effect of cell membrane damage has only been observed in animal experiments and whether it occurs in humans remains unclear.

NUCLEATION SITES

When the insonified tissue contains bubbles, gas or vapor, the ultrasound-induced strain may induce cavitation originating from the location of the gas, termed as a “nucleation site”. The exact nature and source of nucleation sites are not well understood in a complex medium such as tissue. Theoretical analyses and predictions have not yet been verified experimentally.

INERTIAL CAVITATION

The inertial cavitation, called unstable or “transient cavitation” when first observed, refers to the rapid growth and violent collapse of a bubble, seen as a threshold event that tends to increase with frequency. This phenomenon is closely linked to very high temperatures (about 5000°K) and its consequences include the generation of biological toxic compounds, the generation of shock waves, and “sonoluminescence.”

Other mechanical effects

Ultrasound waves can also generate other mechanical effects that are not related to bubbles. They include changes in pressure, force, torque and streaming; they can produce audible sounds and cause electrical changes in cell membranes, thus increasing their patency to large molecules; they can lead to the movement and redistribution of cells in liquid, and they can also damage cells.

RADIATION FORCE

Recently, static or dynamic acoustic radiation force techniques have been applied to ultrasound diagnosis. Amongst the different techniques

that use radiation force to locally move or vibrate tissue, the technique used by the Aixplorer® Mach 30 system is Supersonic Shear Imaging. This technique utilizes the ultrasound-induced temporal-average force on the medium to create the tissue motion. The magnitude of the effect is proportional to the local temporal-average intensity and is in the range of microns.

THRESHOLD PHENOMENA

The cavitation effect is a far more rapid response than temperature rise and is also a threshold phenomenon. In inertial cavitation, the threshold is defined by the amplitude of the ultrasound wave, its frequency, and the size of the pre-existing nucleation sites. The threshold is such that there is a critical size range over which bubbles will undergo inertial cavitation if insonified by an appropriate sound field. In other words, for a given frequency and sound pressure amplitude, bubbles within a certain radius range will undergo inertial cavitation, and those outside of it will not.

LUNG HEMORRHAGE IN ANIMALS

Under experimental circumstances, ultrasound has to be used outside of the diagnostic range in order to be able to detect any adverse bioeffect. Among them, lung hemorrhage is probably the most extensively studied, although its mechanism still remains unclear. Thermal bioeffects and inertial cavitation have both been excluded as being responsible for lung lesions. However, general observations can be made from the large amount of ultrasound-induced lung damage threshold studies. First, the degree of damage observed in animals does not appear to be a concern since the extent of lung damage is limited and the organ can recover from the effect. Second, the mechanisms of lung injury seem to be similar in all species and the features of the lesions induced are independent from the frequency, pulse repetition frequency, and the beamwidth. Therefore similar biological mechanisms may be of concern in patients undergoing ultrasound lung exposure, and especially patients with pulmonary disorders or “at risk” neonates.

Benefits of ultrasound versus risks

Benefits of use

Without question, ultrasound imaging has had a significant impact on the field of medical diagnostic imaging. Examples of the benefits of ultrasound diagnostic imaging can be easily found in cardiology and obstetrics. In cardiology, ultrasound allows for the detailed visualization of the anatomical structure and function of the heart and its great vessels. The radiologist can see the blood flow within the heart ventricles and atria as well as the function of the valves under normal and pathological conditions. In obstetrics, there is a particular concern for potential bioeffects on the embryo-fetus during pregnancy. However, because of its excellent safety record, this imaging modality is routinely used worldwide. During the past few years, the technology of ultrasound imaging has greatly improved and refers to an expanding array of clinical applications. A variety of ultrasound systems are currently available for specific medical and clinical situations such as elasticity imaging, vascular medicine, cardiac studies and musculoskeletal applications. Recent technological developments have allowed for images of far better quality and also better diagnostic information. However, these technological advances and applications also require more responsibility to be assumed by the operators. From both healthcare systems and patients' perspectives, the cost effectiveness and non invasive nature of ultrasound examinations make them very well tolerated. Ultrasound examinations are universally accepted by patients and their reimbursement agencies.

Risks of use

Despite the excellent safety record, the potential risk of adverse biological effects at the tissue and cellular levels exist. As mentioned above, biological mechanisms of lung injury similar to the ones observed in non-human mammals may be of concern in patients undergoing sonographic procedures with lung exposure. There is also the theoretical potential for bioeffects to occur at the subcellular level, although these effects are poorly understood. Adverse bioeffects that were observed in mammals

have never been reported to occur in human patients. Therefore, the regulation now reinforces the operator's responsibility in limiting the potential risk of ultrasound adverse bioeffects to their patients. To achieve this, the operator should be given all the necessary information to make an informed balanced decision, weighing possible bioeffects against the expected diagnostic information. However, newer applications (transesophageal echocardiography, intravascular ultrasound) may cause bioeffects that have never been anticipated. Further specific research is needed in these fields before all risks can be defined.

Risks of not using ultrasound

In the meantime, ultrasound operators should permanently weigh potential biological effects against the real risks of not doing the examination and thus missing key diagnostic information. In obstetrics and cardiology, the clinical diagnostic value of ultrasound information is so well accepted by the medical community, that it is acknowledged that there is a higher risk to the patient if an ultrasound exam is not performed. Ultrasound imaging provides a large amount of highly valuable clinical information that is pertinent to a variety of diagnostic applications. This information can be used instead of a higher risk procedure, or can be used in conjunction with other diagnostic procedures, in order to improve diagnostic confidence or to obtain crucial diagnostic information. In most cases, obtaining the same information with other tests or imaging methods would be at a higher cost or with increased risk.

Increase in risk as acoustic output increases

At the tissue site where the ultrasound temporal-average intensity is I_{TA} , the rate of heat generation per unit volume is given by the expression $Q = 2\alpha I_{TA}$, where α stands for the ultrasonic amplitude absorption coefficient. This means that the increase in temperature is proportional to an average value of the ultrasound intensity over a time period, also called the acoustic output. Therefore, the risk of generating thermal bioeffects within insonified tissues depends directly on the acoustic output.

Increase in diagnostic information as acoustic output decreases

Since 1991, the technical evolution of ultrasound systems has allowed for significant increases in acoustic output and therefore has led to better spatial resolution, enhanced contrasts, increased image definition and improved diagnostic sensitivity. Real 3D and 4D imaging modes, color Doppler, and recently strain imaging illustrate the new and enhanced imaging capabilities of current ultrasound systems. Other potential benefits of increasing the acoustic output include the ability to image at greater depths due to improved echo and Doppler signal acquisition and penetration, and improvements in resolution due to the transmission of higher frequencies. Simultaneously, the scientific knowledge of biological adverse effects of ultrasound has largely expanded and has raised the concept of weighing the risks against the benefits of getting a better ultrasound image.

Increase in responsibility for user at higher output levels

In relaxing the limits of the acoustic output power on current ultrasound systems, the regulatory authorities of course have allowed the development of increased diagnostic capabilities and image quality, but they have also placed increased responsibility on operators. The operator has to evaluate the risks and benefits of diagnostic ultrasound in general, but also of increasing the acoustic output power to get better images. To fulfil this responsibility, ultrasound operators need to have full knowledge of ultrasound systems and tools. This requires specific education and training, which has now been included as part of the accreditation process for ultrasound clinical use in most developed countries.

The operator should:

- be familiar with the possible risk factors,
- be aware of the need to adjust the acoustic output to obtain a good image,
- evaluate and consider the patient's clinical state and
- know all the system controls that affect the acoustic output.

Current ultrasound systems allow the operator to balance risks versus benefits and make an informed decision. Systems display real-time information on the potential risks of adverse bioeffects via indices that refer to the output intensity and the possible thermal and mechanical risks (Thermal Index: TI, and Mechanical Index: MI). According to the NCRP, the risks of diagnostic ultrasound have to be weighed against the benefits when the MI is above 0.5 or the TI is above 1.0. Practically speaking, generating a better image may lead to greater risks, especially depending on the patient's anatomy and presentation: thin and obese patients do not present the same risks, full and empty bladder at the time of examination do not have the same risks, and the presence of gas bubbles in the scanned area of the body may increase risk.

The ALARA principle

According to the International Commission of Radiological Protection “Medical exposure is the only category in which large reductions in average dose are possible, and it is therefore highly desirable to reduce applications of medical radiation which are of no benefit to the patients and to minimize useless radiation in the course of medical examinations”. To reduce the risks related to ultrasound exposure, the ALARA principle can be applied to ultrasound examinations. ALARA stands for “As Low As Reasonably Achievable”. It means that the total ultrasound exposure has to be kept as low as reasonably achievable, in order to guarantee the patient's safety while optimizing diagnostic information.

Controlling energy

The ALARA principle applied to ultrasound diagnostic imaging recommends that the total ultrasound energy should be maintained below a level at which bioeffects are generated while diagnostic information is preserved. The implementation of ALARA enables obtaining the information needed while keeping the potential for bioeffects as low as reasonably achievable. The operator should start the exam by selecting the correct transducer frequency and application and then use a low output level. Then all image quality controls should be used to optimize the image (focus, receiver gain...). Only if the image is not diagnostically useful at this point, then acoustic output can be increased. The output power control allows the operator to select intensity levels less than the

established maximum. Prudent use dictates that the operator select the lowest output intensity that is consistent with good image quality.

Controlling exposure time

The indices that are displayed do not take into account the length of exposure. As the total amount of energy received at a location is proportional to length of exposure of this particular site, the operators should also keep the total exposure time in one location as short as possible. Therefore, a more complete definition of the ALARA principle is to use the lowest output setting that will yield the best possible diagnostic information, while keeping the exposure time as short as possible.

Controlling scanning technique

The operating guidelines that derive from the ALARA principle should remain very clear and have the only goal of quality of the diagnostic information.

In addition, the operator should ensure that:

- only medically required scanning is performed,
- an exam is not rushed,
- the quality is never compromised.

A poor exam will most probably require a secondary exam or a follow-up, thus increasing exposure time.

Controlling system setup

Selecting the most appropriate system setup (transducer, application) is the first step to take before starting an ultrasound scan. Then the operator should select the correct range of acoustic intensity for the application, if not done automatically by the system. Ultimately, the operator has the responsibility for proper clinical use. The Aixplorer®

Mach 30 ultrasound system provides both automatic (default) settings and manual (user-selectable) settings.

Effects of system capabilities

The system offers the possibility to control the acoustic output thanks to 3 different types of controls.

Direct controls affect directly the acoustic intensity. They include the Application Selection (see above) and the control of the Output Power. The Application Selection affects the allowable output intensity range. Selecting the correct range of acoustic intensity for the application is one of the first things that occur in any exam. For example, peripheral vascular intensity levels are not recommended for fetal exams. Some systems automatically select the proper range for a particular application, while others require manual selection. Ultimately, the user has the responsibility for proper clinical use. The Aixplorer® Mach 30 ultrasound system provides both automatic (default) settings and manual (user-selectable) settings. The Output Power directly affects the acoustic intensity, by increasing or decreasing it. Once the application has been established, the Output Power control allows the operator to select intensity levels less than the established maximum. Prudent use dictates that the operator select the lowest output intensity that is consistent with good image quality.

Indirect Controls are those that have an indirect effect on acoustic intensity. They refer to the transducer selection (see “Effects of transducer capabilities” below), the imaging mode (see “Effects of operating mode” below), the pulse repetition frequency, the focal depth and the pulse length. All of them indirectly impact the output intensity for specific reasons: for example, the transducer operating frequency has to be adapted to the expected depth of scanning; also, a scanned and a stationary mode will not deliver the same amount of energy in a particular location. For complete details on other indirect controls the operator should refer to sub-section “Indirect Controls” in the section “Applying ALARA with the Aixplorer® Mach 30 Ultrasound Imaging System”. Pulse repetition frequency or rate refers to the number of ultrasound bursts of energy over a specific period of time. The higher the pulse repetition frequency, the more pulses of energy in a period of time. Several controls affect pulse repetition frequency: focal depth, display depth, sample volume depth, flow optimization, scale, number of focal

zones, and sector width controls. Focus of the ultrasound beam affects the image resolution. To maintain or increase resolution at a different focus requires a variation in output over the focal zone. This variation of output is a function of system optimization. Different exams require different focal depths. Setting the focus at the proper depth improves the resolution of the structure of interest. Pulse length is the time during which the ultrasonic burst is turned on. The longer the pulse, the greater the time-average intensity value. The greater the time-average intensity, the greater the likelihood of temperature increase and cavitation. Pulse length or burst length or pulse duration is the output pulse duration in pulsed Wave Doppler. Increasing the Doppler sample volume size increases the pulse length.

Receiver controls have no effect on acoustic output and can be used by the operator to improve image quality. They only change the way the ultrasound echo is received and should always be used before the output power is increased. They include gain, TGC, dynamic range, and image processing features. The important thing to remember, relative to output, is that receiver controls should be optimized before output is increased. For example: before increasing output, optimize gain to improve image quality.

Effects of operating mode

The choice of imaging mode determines the nature of the ultrasound beam. For example, the B-Mode is a scanning mode, while Doppler is a stationary or unscanned mode. A stationary ultrasound beam concentrates energy in a single location. A moving or scanned ultrasound beam disperses the energy over an area such that the beam is concentrated on the same area for only a fraction of the time as that of an unscanned mode.

Effects of transducer capabilities

Transducer selection indirectly affects acoustic output intensity. Tissue attenuation changes with frequency. The higher the transducer operating frequency, the greater the attenuation of the ultrasonic energy. A higher transducer operating frequency requires more output intensity to scan at a deeper depth. To scan deeper at the same output intensity, a lower transducer frequency should be required. Using more gain and output

beyond a point, without corresponding increases in image quality, can mean that a lower frequency transducer is needed.



WARNING

Ultrasound exposure time should always be limited; however, do not rush the exam.

Ensure that the indices are kept to a minimum and that exposure time is limited without compromising diagnostic sensitivity.

The output display standard

Purpose of the output display standard

The system Output Display Standard (ODS) comprises two basic indices: a mechanical index and a thermal index. The thermal index further consists of the following indices: a thermal index for soft tissue (TIS), a thermal index for bone or tissue located near bone (TIB), and a thermal index for cranial bone (TIC). The Aixplorer® Mach 30 user is able to choose the TI and MI display format in the System Configuration, i.e TIS and/or TIB and/or TIC, or the maximum value of the three TI, which in return depends upon the application at hand. Either the TIS or TIB or the maximum value of those indices will be displayed at all times. Which one is displayed depends upon the system preset or user's choice, which in return depends upon the application at hand. The application-specific nature of the default index setting is also an important factor in index behavior. A default setting is a system control state which is preset by the manufacturer or the operator. The system has default index settings corresponding to each transducer application. The default settings are invoked automatically by the ultrasound system when power is turned on, new patient data is entered into the system data base, or a change in application takes place. The decision as to which of the 3 thermal indices, or the maximum value of the three, to display should be based on the following criteria:

- Appropriate index for the clinical application: TIS is used for imaging soft tissue TIB for a focus at or near bone, and TIC when imaging through the cranial bone or near the skull.
- Factors that might create artificially high or low thermal index readings: location of fluid or bone, or blood flow. For example, if there is a highly attenuating tissue path so that the actual potential for local zone heating is less than the thermal index displays.

Scanned modes versus unscanned modes of operation affect the thermal index. For scanned modes, heating tends to be near the surface; for unscanned modes, the potential for heating tends to be deeper in the focal zone.

Mechanical index

Mechanical bioeffects are threshold phenomena that occur when a certain level of output is exceeded. The threshold level varies, however, with the type of tissue. The potential for mechanical bioeffects varies with peak rarefactional pressure and ultrasound frequency. The MI accounts for these two factors. The higher the MI value, the greater the likelihood of mechanical bioeffects occurring. There is no specific MI value that indicates that a mechanical effect is actually occurring. The MI should be used as a guide for implementing the ALARA principle.

Thermal index

The TI informs the user about conditions that might lead to an increase in temperature at the surface of the body, within the body tissue, or at the point of focus of the ultrasound beam on bone. That is, the TI informs the user of the potential for temperature rise in body tissue. It is an estimate of temperature increase in body tissue with specific properties. The actual amount of any temperature rise is influenced by factors such as tissue type, vascularity, mode of operation and others. The TI should be used as a guide for implementing the ALARA principle. The bone thermal index (TIB) informs the user about potential heating at or near the focus after the ultrasound beam has passed through soft tissue or fluid, for example, at or near second or third trimester fetal bone. The cranial bone thermal index (TIC) informs the user about the potential heating of bone at or near the surface, for example, cranial bone. The TI informs the user about the general potential for heating within tissue. Depending on the Aixplorer®

Mach 30 user's choice, the TIS or TIB or TIC or the maximum value of the three is continuously displayed over the range of 0.0 to maximum output. The mechanical index is continuously displayed over the range of 0.0 to 1.9.

System display levels and accuracy for MI and TI

As mentioned above, and depending on the Aixplorer® Mach 30 user's choice, the TIS or TIB or TIC, or the maximum value of the three is continuously displayed from 0.0 to maximum output, based on the transducer and application, in increments of 0.1. The mechanical index is continuously displayed from 0.0 to 1.9, in increments of 0.1. Therefore, the MI and TI precision is 0.1 unit on the Aixplorer® Mach 30 system. The MI and TI display accuracy estimates for the Aixplorer® Mach 30 system are given in Acoustic Output Tables in this user manual. These accuracy estimates are based on the variability range of transducers and systems, inherent acoustic output modelling errors and measurement variability, as discussed below. The displayed values should be interpreted as relative information to help the operator achieve the ALARA principle through prudent use of the system. The values should not be interpreted as actual physical values in interrogated tissues or organs. The initial data that is used to support the output display is derived from laboratory measurements based on the AIUM measurement standard. The measurements are then put into algorithms for calculating the displayed output values. Many of the assumptions used in the process of measurement and calculation are conservative in nature. Over-estimation of actual in situ intensity exposure, for the vast majority of tissue paths, is built into the measurement and calculation process. For example:

- The measured water tank values are derated using a conservative, industry standard, and attenuation coefficient of 0.3 dB / cm-MHz.
- Conservative values for tissue characteristics were selected for use in the TI models. Conservative values for tissue or bone absorption rates, blood perfusion rates, blood heat capacity, and tissue thermal conductivity were selected.
- Steady-state temperature rise is assumed in the industry standard TI models, and the assumption is made that the ultrasound transducer is held steady in one position long enough for steady state to be achieved.

A number of factors are considered when estimating the accuracy of the displayed values: hardware variations, estimation algorithm accuracy, and measurement variability. Variability among transducers and systems is a significant factor. Transducer variability results from piezoelectric crystal efficiencies, process-related impedance differences, and sensitive lens focusing parameter variations. Differences in system pulser voltage control and efficiency may also contribute to variability. There are inherent uncertainties in the algorithms used to estimate acoustic output values over the range of possible system operating conditions and pulser voltages. Inaccuracies in laboratory measurements are related to, among others, differences in hydrophone calibration and performance, positioning, alignment, and digitization tolerances, and variability among test operators. The conservative assumptions of the output estimation algorithms of linear propagation, at all depths, through a 0.3 dB/cm-MHz attenuative medium is not considered in the accuracy estimate for the display. Neither linear propagation, nor uniform attenuation at the 0.3 dB/cm-MHz rate, occurs in water tank measurements or in most tissue paths in the body. In the body, different tissues and organs have dissimilar attenuation characteristics. In water, there is almost no attenuation. In the body, and in particular, in water tank measurements, non-linear propagation and saturation losses occur as pulser voltages increase. Therefore, the display accuracy estimates are based on the variability range of transducers and systems, inherent acoustic output modelling errors, and measurement variability. Display accuracy estimates are not based on errors in, or caused by measuring according to, the AIUM measurement standards, or the effects of non-linear loss on the measured values.

Meaning of the TI and MI relation with bioeffects

THERMAL INDEX

The TI gives a relative indication of the potential for temperature increase at a specific point along the ultrasound beam. The reason for the term 'relative' is that the assumed conditions for heating in tissue are so complex that this index cannot be assumed to give the actual increase in temperature for all possible conditions. Thus, a TI of 2 represents a higher temperature rise than a TI of 1, but does not necessarily represent a rise of

2° C. This temperature rise is a theoretical estimate based on experimental conditions that may not apply to clinical conditions. The important point to remember about the TI is that it is designed to make users aware of the possible temperature rise at a particular point in tissue. The concern over temperature rise induced by ultrasound in the body is based on observed changes in cellular activity as a function of temperature. In general, for healthy activity of enzymes, the enzymatic activity doubles for every 10° C rise. The human body is able to tolerate hot drinks and fevers for a certain period of time. A fever of +2° C is not a problem, where 37° C is taken as an average core body temperature. The following table identifies stages of temperature effects.

Table 3.4. Temperature effect from Millet and Ziskin, 1989

Temperature range (°C)	Effect
37-39	No harmful effects for extended periods
39-43	Detrimental effects for long enough times
>41	Threshold for fetal problems for extended periods
44-46	Coagulation of proteins
>45	Enzymes become denatured
>41.8	Cancer cells die (fail to reproduce) Often taken as damage threshold, except eye

The temperature rise in tissue during ultrasonic exposure is due to the absorption of acoustic energy. Absorption is the conversion of ultrasonic energy into heat. The extent of the absorption depends on the tissue type. A specific way in which tissue absorption characteristics are quantified is the “Absorption coefficient”. The absorption coefficient is expressed in decibels per centimeter per MegaHertz. Absorption coefficients are very dependent on the organ or tissue type that is being imaged. Amniotic fluid, blood and urine have very low absorption coefficients, which mean that there is little temperature elevation and the ultrasound goes through the fluid with very little decrease. Bone, however, has a very high absorption coefficient. Dense bone absorbs the energy very quickly and causes the temperature to rise rapidly. Soft tissues vary in density depending on the particular organ, but the density does not vary much within an organ. Ultrasonic frequency affects absorption. The higher the frequency, the higher the absorption. How to minimize temperature rise: The temperature increase depends on the intensity, duration of exposure at the same location, transducer focal point size and location,

and absorption of the energy by the tissue. The operator can control the intensity (output power control), the duration or the exposure time. The transducer is typically moved frequently during the exam, which reduces the exposure duration at a specific tissue location. The other important factor of temperature rise is absorption of the ultrasound energy in tissue layers in front of the point of interest. Increased absorption in these layers decreases the ultrasound energy available at the point of interest.

MECHANICAL INDEX

In addition to heat effect, various types of mechanical effects on the body are generated by ultrasonic exposure. These effects can be divided into two categories. The first category is called acoustic cavitation. Cavitation can occur when sound passes through an area that contains a cavity, such as a gas bubble or other air pocket. Some tissues, most notably adult lung and intestine, do contain air bubbles, and are therefore more vulnerable to these cavitation effects. The fetal lung and intestine do not contain obvious air bubbles, because the fetus does not breathe air yet—it gets oxygen from the mother’s blood stream. However, tiny bubbles could potentially form in parts of the body other than the lung and intestine. More research is needed in this area. In cavitation, the sound waves can cause the bubbles or air pockets to expand and contract rhythmically: in other words, to pulsate, or resonate. When they pulsate, the bubbles send secondary sound waves off in all directions. If the bubbles contract towards the point of collapsing, they can build up very high temperatures and pressures for a few tens of nanoseconds. These high temperatures and high pressures can produce highly reactive chemicals called free radicals, and other potentially toxic compounds which, although considered unlikely, could theoretically cause genetic damage. The rapid contraction of bubbles in cavitation can also cause micro-jets of liquid which can damage cells. When diagnostic ultrasound is focused on the lung or intestine of laboratory animals, which contain gas bubbles, these cavitation effects can cause ruptures in very small blood vessels. The safety guidelines for diagnostic ultrasound are designed to try to prevent cavitation effects, because these effects can be damaging. Restrictions on the pressure amplitude of the ultrasound pulse, in combination with awareness of whether or not there are gas bubbles in the tissue being imaged, can help prevent cavitation. Other factors such as the length of the pulse, and the density of the liquid, also influence whether or not cavitation occurs. And if there are gas bubbles, the number, size and location of the bubbles also contribute to the effect. The occurrence

of cavitation and its behavior depend on many factors, including the ultrasonic pressure and frequency, the focused or unfocused and pulse or continuous ultrasonic field, the degree of standing waves, and the nature and state of the material and its boundaries. Currently there is no evidence of cavitation occurring in human tissue or fluids resulting from diagnostic ultrasonic exposure. In addition, the control parameters on our ultrasound imaging system limit the peak output. Ultrasound can also create other mechanical effects that do not require the presence of bubbles in order to occur. These effects include changes in pressure, force, torque (causing things to rotate) and streaming (stirring of the liquid). These changes, in turn, can cause audible sounds, electrical changes in cell membranes that make them more permeable to large molecules, movement and redistribution of cells in liquid, and cell damage. When ultrasound passes through liquid, it causes a sort of stirring action called acoustic streaming. As the acoustic pressure of the ultrasound increases, the flow of liquid speeds up. This stirring action, in theory, could occur in fluid-filled parts of a patient's body, such as blood vessels, the bladder or amniotic sac. In experiments with animals, when streaming of the liquid comes near a solid object, shearing can occur, and this can damage platelets and lead to abnormal blood clotting (thrombosis). It is not clear to what extent this effect occurs in humans exposed to diagnostic ultrasound. Although possible adverse effects of ultrasound exist, the overall risk of undergoing an ultrasound diagnostic examination has been found to be minimal, even under moderate to prolonged exposure. Under normal circumstances of diagnostic examination, ultrasound applied prudently using the ALARA principle has been shown to be a safe, effective and reliable diagnostic tool.

Practicing the ALARA principle

How to implement ALARA

ALARA PRINCIPLE

The guiding principle for the use of diagnostic ultrasound is defined by the “As Low As Reasonably Achievable” (ALARA) principle. The decision as to what is reasonable has been left to the judgment and

insight of qualified personnel. No set of rules can be formulated that would be sufficiently complete to dictate the correct response to every circumstance. By keeping ultrasound exposure as low as possible, while obtaining diagnostic images, users can minimize potential ultrasonic bioeffects.

USERS SHOULD FOLLOW THE ALARA PRINCIPLE IN ALL STUDIES

Since the threshold for diagnostic ultrasound bioeffects is undetermined, it is the operator's responsibility to control total energy transmitted into the patient. The operator must reconcile exposure time with diagnostic image quality. To ensure diagnostic image quality and limit exposure time, an ultrasound system provides controls that can be manipulated during the exam to optimize the results of the exam. The ability of the user to abide by the ALARA principle is important. Advances in diagnostic ultrasound - not only in the technology but in the applications of that technology, have resulted in the need for more and better information to guide the user. The output display indices are designed to provide that important information. There are a number of variables which affect the way the output display indices can be used to implement the ALARA principle. These variables include index values, body size, location of the bone relative to the focal point, attenuation in the body, and ultrasound exposure time. Exposure time is an especially useful variable, because it is controlled by the user. The ability to limit the index values over time supports the ALARA principle.

IMPLEMENTING ALARA USING THE TI AND MI INDICES

The ALARA concept is achieved by using the information displayed on the screen in the form of biologically relevant exposure indices: the TI and the MI. The display of biological index information is only a tool. Safe use of the ultrasound imaging device can be ensured by using the lowest indices that will yield the best possible diagnostic information.

SYSTEM CONTROLS VERSUS ACOUSTIC OUTPUT

An ultrasound scan of a patient begins with selecting the appropriate transducer frequency. After selecting the transducer and the application, which are based on patient anatomy, adjustments to output power should be made to ensure that the lowest possible setting is used to acquire an image. After the image is acquired, adjusting the focus of the transducer, and then increasing the receiver gain, dynamic range, and the TGC to produce a uniform representation of the tissue follows. If an adequate image can be obtained with the increase in gain and adjusting the TGC, then a decrease in output should be made. Only after making these adjustments should the operator increase output to the next level. Having acquired the B-mode display of the scanned organ, Color Flow Imaging can be used to localize blood flow. As with the B-mode image display, gain, TGC, and image processing controls must be optimized before increasing output. Having localized the blood flow, use the Doppler controls to position the sample volume over the vessel. Before increasing output, adjust velocity range or scale and Doppler gain to obtain an optimal Doppler trace. Only if maximum Doppler gain does not create an acceptable image does the operator increase output. In summary: select the correct transducer frequency and application for the job; start with a low output level; optimize the image using focus, receiver gain, and other imaging controls; if the image is not diagnostically useful at this point, then increase output. Overall gain and TGC are the 2 most important receiver controls that must be used by the operator to improve image quality, before increasing the acoustic output. These controls have no effect on acoustic output and only affect the way the ultrasound echo is received. The important thing to remember, relative to output, is that receiver controls should be optimized before output is increased. For example: before increasing output, optimize gain to improve image quality. Dynamic range and image post-processing are also receiver controls that have no effect on acoustic output power. Again, it is of first importance for the operator to remember that these two controls also should be optimized before output is increased.

System application versus acoustic output

Application selection and the Output Power control directly affect acoustic intensity. There are different ranges of allowable intensity or output based on operator's selection. Selecting the correct range of acoustic intensity for the application is one of the first things that occurs in any exam. For example, peripheral vascular intensity levels are not recommended for fetal exams. Some systems automatically select the proper range for a particular application, while others require manual selection. Ultimately, the user has the responsibility for proper clinical use. The Aixplorer® Mach 30 ultrasound system provides both automatic (default) settings and manual (user-selectable) settings. Output Power has direct impact on acoustic intensity. Once the application has been established, the Output Power control can be used to increase or decrease the intensity output. The Output Power control allows the operator to select intensity levels less than the established maximum. Prudent use dictates that the operator selects the lowest output intensity that is consistent with good image quality.

Transducer effect on acoustic output

The controls that affect the acoustic output are:

- pulse repetition frequency,
- focus depth,
- pulse length,
- transducer selection.

Pulse repetition frequency or rate refers to the number of ultrasound bursts of energy over a specific period of time. Dwell time is equal to the inverse of the pulse repetition frequency minus the burst length. The higher the pulse repetition frequency, the more pulses of energy in a period of time and the shorter the dwell time. Several controls affect pulse repetition frequency: focal depth, display depth, sample volume depth, flow optimization, scale, number of focal zones, and sector width controls. Focus of the ultrasound beam affects the image resolution. To maintain or increase resolution at a different focus requires a variation in output over the focal zone. This variation of output is a function of system optimization. Different exams require different focal depths.

Setting the focus at the proper depth improves the resolution of the structure of interest. Pulse length is the time during which the ultrasonic burst is turned on. The longer the pulse, the greater the time-average intensity value. The greater the time-average intensity, the greater the likelihood of temperature increase and cavitation. Pulse length, also known as burst length or pulse duration, is the output pulse duration in pulsed Doppler. Increasing the Doppler sample volume size increases the pulse length. Transducer selection indirectly affects intensity. Tissue attenuation changes with frequency. The higher the transducer operating frequency, the greater the attenuation of the ultrasonic energy. A higher transducer operating frequency requires more output intensity to scan at a deeper depth. To scan deeper at the same output intensity, a lower frequency transducer is required. Using more gain and output beyond a point, without corresponding increases in image quality, can mean that a lower frequency transducer is needed.

System operating modes versus acoustic output

The choice of imaging mode determines the nature of the ultrasound beam. B-mode is a scanning mode, Doppler and M-mode are stationary or unscanned modes. A stationary ultrasound beam concentrates energy in a single location. A moving or scanned ultrasound beam disperses the energy over an area such that the beam is concentrated on the same area for only a fraction of the time as that of an unscanned mode. ShearWave™ Elastography mixes the two types of scanned and unscanned modes:

- the generation of the acoustic radiation force is a scanned ultrasound emission,
- the acquisition of the Shearwave propagation is achieved by unscanned flat insonification at a very high frequency (UltraFast™),
- the B mode imaging is performed in an interleaved manner with the elastography sequence and is a scanned mode.

Control of exposure time

One important contributor to ALARA, not incorporated in the output display indices, is the element of time. As the total exposure is directly

proportional to the amount of time the ultrasound beam remains in one area, users should remember that, besides keeping the TI and MI as low as possible, the total exposure time in any one location should be kept as short as possible. The concept of ALARA is to use the lowest output setting that will yield the best possible diagnostic information, while keeping the exposure time as short as possible. With a clear understanding of the new responsibilities, users will have more capabilities and potentially more diagnostic information available from these higher output devices, while minimizing risk to patients. Ensure that scanning time is kept to a minimum, and ensure that only medically required scanning is performed. Never compromise quality by rushing through an exam. A poor exam may require a follow-up, which ultimately increases exposure time. Diagnostic ultrasound is an important tool in medicine, and, like any tool, it should be used efficiently and effectively.

Applying ALARA with the Aixplorer® Mach 30 ultrasound imaging system

The system imaging mode used depends upon the information needed. B-mode imaging provides anatomical information. Pulsed Doppler, Color Power Imaging (CPI), Directional Color Power Imaging (dCPI) and Color Flow Imaging (CFI) provide information about blood flow. The M-mode is used for cardiac assessment and measurement of the fetal heart rate. ShearWave™ Elastography Imaging displays information about tissue stiffness via color-scale or grayscale. A scanned mode, like B-mode, SWE™, CPI, dCPI, or CFI, disperses or scatters the ultrasonic energy over an area, while an unscanned mode, like Pulsed Wave Doppler, concentrates ultrasonic energy. The M-mode should be used instead of spectral Pulsed Wave Doppler imaging to document embryonic/fetal heart rate. Understanding the nature of the imaging mode being used allows the operator to apply the ALARA principle with informed judgment. Additionally, knowing the transducer frequency, system setup values, and scanning techniques, and the operator's experience allow him or her to meet the ALARA principle. The decision as to the amount of acoustic output is, in the final analysis, up to the operator. This decision must be based on the following factors: type of patient, type of exam, patient history, ease or difficulty of obtaining diagnostically useful information, and the potential localized heating of the patient due to transducer surface temperatures. Prudent use of the system occurs when patient exposure is limited to the lowest index

reading for the shortest amount of time necessary to achieve acceptable diagnostic results. Although a high index reading does not mean that a bioeffect is actually occurring, a high index reading should be taken seriously. Every effort should be made to reduce the possible effects of a high index reading. Limiting exposure time is an effective way to accomplish this goal. There are several system controls that the operator can use to adjust the image quality and limit the acoustic intensity. These controls are related to the techniques that an operator might use to implement ALARA. These controls can be divided into three categories: direct, indirect, and receiver controls. As various system controls are adjusted, the TI and MI values may change. This will be most apparent as the Output Power control is adjusted; however, other system controls will affect the on-screen output values.

DIRECT CONTROLS

Output power

Output Power controls the system acoustic output. Two real-time output values are on the screen: a TI and MI. They change as the system responds to Output Power adjustments. In combined modes, such as simultaneous CFI, B-mode, the individual modes each add to the total TI. One mode will be the dominant contributor to this total. The displayed MI will be from the mode with the largest peak pressure.

INDIRECT CONTROLS

B-mode controls

SECTOR WIDTH

Narrowing the sector angle may increase frame rate. This action will increase the TI. Pulsar voltage may be automatically adjusted down with software controls to keep the TI below the system maximums. A decrease in pulsar voltage will decrease MI.

ZOOM

Increasing the zoom magnification by pressing Zoom may increase frame rate. This action will increase the TI. The number of focal zones may also increase automatically to improve resolution. This action may change MI since the peak intensity can occur at a different depth.

NUMBER OF FOCAL ZONES

More focal zones may change both the TI and MI by changing frame rate or focal depth automatically. Lower frame rates decrease the TI. MI displayed will correspond to the zone with the largest peak intensity.

FOCUS

Changing the focal depth will change MI. Generally, higher MI values will occur when the focal depth is near the natural focus of the transducer.

M-mode controls

The M-mode is accessible from the B-mode controls. All 2D controls mentioned above apply to the M-mode image. Similarly, the MI and/or TI are displayed on the Aixplorer® Mach 30 monitor when operated in M-mode. Additional indirect controls dedicated to the M-mode also impact on the TI and MI.

SAMPLE VOLUME DEPTH

When M-mode sample volume depth is increased the PRF may automatically increase, leading to an increase of the TI.

CFI, CPI and dCPI controls

VELOCITY OPT.

Increasing the Color sensitivity with the Velocity Opt control may increase the TI. More time is spent scanning the Color image. Color pulses are the dominant pulse type in this mode.

COLOR BOX/SECTOR WIDTH

Narrower color sector width will increase color frame rate and the TI will increase. The system may automatically decrease pulser voltage to stay below the system maximum. A decrease in pulser voltage will decrease the MI.

COLOR BOX/SECTOR DEPTH

Deeper color sector depth may automatically decrease color frame rate or select a new color focal zone or color pulse length. The TI will change due to the combination of these effects. Generally, the TI will decrease with increased color sector depth. MI will correspond to the peak intensity of the dominant pulse type which is a color pulse.

SCALE

Using the scale control to increase the color velocity range may increase the TI. The system may automatically adjust pulser voltage to stay below the system maximums. A decrease in pulser voltage will also decrease MI.

SECTOR WIDTH

A narrower 2D sector width in Color imaging will increase color frame rate. The TI will increase. MI will not change.

Pulsed Wave Doppler controls

SAMPLE VOLUME DEPTH

When Doppler sample volume depth is increased the Doppler PRF may automatically decrease. An increase in PRF will increase the TI. The system may also automatically decrease the pulser voltage to remain below the system maximum. A decrease in pulser voltage will decrease MI.

Continuous Wave Doppler controls

CW SCALE

When the CW Scale is increased the Doppler PRF may automatically increase.

Elastography controls

ELASTOGRAPHY BOX/SECTOR WIDTH

Narrower Elastography sector width may increase elastography frame rate and the TI will increase. The system may automatically decrease pulser voltage to stay below the system maximum. A decrease in pulser voltage will decrease the MI.

ELASTOGRAPHY BOX/SECTOR DEPTH

Deeper Elastography sector depth may automatically decrease elastography frame rate. The TI will change. Generally, the TI will decrease with increased Elastography sector depth. MI will correspond to the peak intensity of the dominant pulse type in the combined mode.

SECTOR WIDTH

A narrower 2D sector width in Elastography imaging will decrease the Elastography frame rate. The TI will increase. MI will not change.

Other

B-MODE, CFI, CPI, DCPI, PULSED WAVE DOPPLER, AND ELASTOGRAPHY

When a new imaging mode is selected, both the TI and MI may change to default settings. Each mode has a corresponding pulse repetition frequency and maximum intensity point. In combined or simultaneous modes, the TI is the sum of the contribution from the modes enabled and MI is the MI for the focal zone and mode with the largest derated intensity.

DEPTH

An increase in B-mode depth will automatically decrease the B-mode frame rate. This would decrease the TI. The system may also automatically choose a deeper B-mode focal depth. A change of focal depth may change the MI. The MI displayed is that of the zone with the largest peak intensity.

APPLICATION

Acoustic output defaults are set when the operator selects an application. Factory defaults vary with transducer, application, and mode. Defaults have been chosen below the FDA limits for intended use.

Clinical application examples

SMALL PARTS

For any small parts, the clinician starts with selecting the appropriate application and Tissue Preset Setting (Breast/Breast, Genitourinary/Scrotum, Thyroid/Thyroid, or General on the L18-5 or Breast or General on the LV16-5 or Breast or Thyroid on the L10-2, or Breast on the L18-5), the clinician starts imaging the tissue and starts adjustments of the output power to ensure that the lowest possible setting is used to obtain a B Mode image. The user shall then adjust the spread and depth of the focal zone of the transducer, and then using the Auto key or increasing the receiver gain to produce a uniform representation of the tissue follows. If an adequate image can be obtained with the adjustment/ increase in gain, then a decrease in output should be made. Only after making these adjustments should the operator increase output to the next level in the case of an unsatisfying image. Having acquired the B Mode images of the small part/superficial tissue, CFI CPI and/or dCPI can be used to localize blood flow. As with the B Mode image display, gain and image processing controls must be optimized before increasing output, if ever needed. Having localized the blood flow, the clinicians shall use the Pulsed Wave Doppler controls to position the sample volume over the vessel. Before increasing output, the user shall adjust velocity range or scale and Doppler gain to obtain an optimal Doppler trace. Only if maximum Doppler gain does not create an acceptable Doppler spectrum does the operator increase output. Having acquired 2D, Color Flow and Pulsed Wave Doppler, Elastography can be used to assess the tissue stiffness. SWE Opt. setting (Resolution, Standard or Penetration), size and location of the SWE Box and SWE gain shall be adjusted to obtain an optimal Elastography image before increasing output. Only if optimal settings and maximum Elastography gain do not create an acceptable image does the operator increase output. A Three-dimensional acquisition can be performed with the LV16-5 of B-Mode of ShearWave™ Elastography once the conventional two-dimensional planes have been acquired.

MUSCULOSKELETAL

For any MSK imaging, the clinician starts with selecting the appropriate application and Tissue Preset Setting (MSK/ Shoulder, Elbow, Wrist/

Hand, Knee, Ankle/Foot or Muscle on the L18-5, L10-2, LH20-6 probe) then the clinician starts imaging the tissue and starts adjustments of the output power to ensure that the lowest possible setting is used to obtain a B Mode image. The user shall then adjust the spread and depth of the focal zone of the transducer, and then using the AutoTGC key or increasing the receiver gain to produce a uniform representation of the tissue follows. If an adequate image can be obtained with the adjustment/increase in gain, then a decrease in output should be made. Only after making these adjustments should the operator increase output to the next level in the case of an unsatisfying image. Having acquired the B Mode images of the small part/superficial tissue, CFI, CPI and/or dCPI can be used to localize blood flow. As with the B Mode image display, gain and image processing controls must be optimized before increasing output, if ever needed. Having localized the blood flow, the clinicians shall use the Pulsed Wave Doppler controls to position the sample volume over the vessel. Before increasing output, the user shall adjust velocity range or scale and Doppler gain to obtain an optimal Doppler trace. Only if maximum Doppler gain does not create an acceptable Doppler spectrum does the operator increase output. Having acquired 2D, Color Flow and Pulsed Wave Doppler, Elastography can be used to assess the tissue stiffness (not available on LH20-6). SWE Opt. setting (Resolution, Standard or Penetration), size and location of the SWE Box and SWE gain shall be adjusted to obtain an optimal Elastography image before increasing output. Only if optimal settings and maximum Elastography gain do not create an acceptable image does the operator increase output.

ABDOMINAL/PELVIC

For abdominal imaging, the clinician starts with selecting the appropriate transducer (P5-1X for deep abdominal Imaging and L18-5 or L10-2 intestine Preset for superficial) and the appropriate Tissue Preset Setting (Renal, Abdomen, Prostate and Intestine for the L10-2). The clinician then starts imaging the target organ and adjusts the output power to ensure that the lowest possible setting is used to obtain an adequate B Mode image. After the first B Mode image is obtained, adjusting the depth and spread of the focal zone, and then increasing the receiver gain should be used first to produce a uniform representation of the tissue. If an adequate image can be obtained with the increase in gain, then a decrease in output should be made. Only after making these adjustments should the operator increase output to the next level, if ever needed. Having acquired the B Mode images of the target organ, CFI, CPI and/or dCPI can be used to

localize blood flow. As with the B Mode image display, gain and image processing controls must be optimized before increasing output. In case of artifacts due to the increase in gain, the user shall activate the Flash suppression key to be able to increase gain and decrease output acoustic power. Having localized the blood flow, the operator shall use the pulsed wave Doppler controls to position the sample volume over the vessel. Before increasing output, the operator shall adjust velocity range or scale and Doppler gain to obtain an optimal Doppler trace. Only if maximum Doppler gain does not create an acceptable Doppler spectrum does the operator increase output. Having acquired 2D, Color Flow and Doppler, Elastography can be used to assess the organ tissue stiffness. Before increasing output, the user should first adjust the appropriate SWE Opt. setting (Resolution, Standard or Penetration), adjust the size and location of the SWE box and adjust SWE gain to obtain an optimal Elastography image. Only if maximum Elastography gain does not create an acceptable image does the operator increase output.

ENDOCAVITARY (NON OBSTETRICAL)

For genitourinary and gynecologic imaging, the clinician starts with selecting the appropriate transducer (E12-3 for intracavitary scanning), the desired clinical application and the appropriate Tissue Preset Setting (Genitourinary/ Prostate or OB-GYN/Gyn/). The clinician then images the target organ and adjusts the output power to ensure that the lowest possible setting is used to obtain a B Mode image. After the first B Mode image is obtained, adjusting the depth and spread of the focal zone, and then increasing the receiver gain should be used first to produce a uniform representation of the organ. If an adequate image can be obtained with the increase in gain, then a decrease in output should be made. Only after making these adjustments should the operator increase output to the next level, in case of poor quality images. Having acquired the B Mode images of the organ, CFI, CPI and/or dCPI can be used to localize blood flow. As with the B Mode image display, gain and image processing controls must be optimized before increasing output. The user shall then turn on the Power Doppler Mode and adjust its controls to position the sample volume over the vessel. Before increasing output, the user shall adjust velocity range or scale and Doppler gain to obtain an optimal Doppler trace. Only if maximum Doppler gain does not create an acceptable image does the operator increase output. Having acquired B Mode, Color Flow and Pulsed Wave Doppler images, Elastography can be used to assess the target organ tissue stiffness (not available on any obstetrical presets).

Before increasing output, the user should first adjust the appropriate SWE Opt. setting (Resolution, Standard or Penetration), adjust the size and location of the SWE box and adjust SWE gain to obtain an optimal Elastography image. Only if maximum Elastography gain does not create an acceptable image does the operator increase output.

VASCULAR

For vascular imaging, the clinician starts with selecting the appropriate transducer (L18-5 and MC12-3 for superficial vascular imaging, L10-2 for deep vascular imaging; C6-1X for vascular abdominal imaging and P5-1X for Transcranial imaging) and the appropriate Tissue Preset Setting (Carotid, Upper Extremity Arterial/Venous, Lower Extremity Arterial/Venous for L18-5, MC12-3 or L10-2, Vascular Abdominal for C6-1X, TCD, Abdominal Vascular or Renal for P5-1X). The clinician then starts imaging the target vessel or organ and adjusts the output power to ensure that the lowest possible setting is used to obtain an adequate B Mode image. After the first B Mode image is obtained, adjusting the depth and spread of the focal zone, and then increasing the receiver gain should be used first to produce a uniform representation of the vessel or the organ. If an adequate image can be obtained with the increase in gain, then a decrease in output should be made. Only after making these adjustments should the operator increase output to the next level, if ever needed. Having acquired the B Mode images of the target vessel or organ, CFI, CPI and/or dCPI can be used to localize blood flow. As with the B Mode image display, gain and image processing controls must be optimized before increasing output. In case of artifacts due to the increase in gain, the user shall activate the Flash suppression key to be able to increase gain and decrease output acoustic power. Having localized the blood flow, the operator shall use the pulsed wave Doppler controls to position the sample volume over the vessel. Before increasing output, the operator shall adjust velocity range or scale and Doppler gain to obtain an optimal Doppler trace. Only if maximum Doppler gain does not create an acceptable Doppler spectrum does the operator increase output.

OBSTETRICS

Diagnostic ultrasound studies of the fetus are generally considered safe during pregnancy. This diagnostic procedure should be performed only when there is a valid medical indication, and the lowest possible

ultrasonic exposure setting should be used to gain the necessary diagnostic information under the ALARA (as low as reasonably achievable) principle. The thermal index for soft tissue (TIS) should be used at earlier than 10 weeks' gestation, and the thermal index for bone (TIB) should be used at 10 weeks' gestation or later when bone ossification is evident. In keeping with the ALARA principle, M-mode imaging should be used instead of spectral Doppler imaging to document embryonic/fetal heart rate. For a use of the Early OB preset on the E12-3, the system is limiting the Mechanical Index to a maximum value of 1.0 (on both probes) and the Thermal Index to a maximum value of 2.0 (on both probes). These limits are following the recommendations and the guidelines for safe use of an ultrasound diagnostic system during a fetal exam:

- American institute of ultrasound of medicine (AIUM)
- British medical ultrasound society (BMUS)
- European committee for medical ultrasound safety (ECMUS)
- Société des obstétriciens et gynécologues du Canada (SOCG) et Santé Canada

And more particularly the information provided by the AIUM on the ultrasound biological effects, its recommendations published in the Journal of Ultrasound in Medicine in April 2008, and the article published by DL Miller. During the first trimester of pregnancy and especially during the first 10 weeks, it is essential to follow these recommendations. For obstetrics imaging, the clinician starts with selecting the appropriate transducer (E12-3 for Early OB scanning, C6-1X for General OB scanning) and the desired clinical application (OB-GYN- application, GYN, Early OB or Gen OB). The clinician then images the target organs and adjusts the output power to ensure that the lowest possible setting is used to obtain a B Mode image. (Obstetrics presets have a limited Mechanical Index and Thermal Index [MI & TI] to follow the recommendations and guidelines from AIUM, BMUS, ECMUS and SOCG). After the first B Mode image is obtained, adjusting the depth and spread of the focal zone, and then increasing the receiver gain should be used first to produce a uniform representation of the organ. If an adequate image can be obtained with the increase in gain, then a decrease in output should be made. Only after making these adjustments should the operator increase output to the next level, in case of poor quality images. Having acquired the B Mode images of the organs, CFI, CPI and/or dCPI can be used to localize blood flow. As with the B Mode image display, gain and image processing controls must be optimized before increasing output.

Having acquired B Mode and Color Flow, the user can image the desired organ using M Mode imaging. M Mode can be used to assess the beats per minute of fetal cardiac activity. Before increasing output, the user should first adjust the appropriate B/M Modes parameters such as gain, maps, and dynamic range; adjust the size and location of the M zone to obtain an optimal M Mode trace. Only if maximum M-Mode gain does not create an acceptable trace does the operator increase output. Having acquired B Mode, Color Flow and M Mode, the clinician also has the ability to use the Pulsed Wave (PW) Doppler Mode and adjust its controls to position the sample volume over the vessel. Before increasing output, the user shall adjust velocity range or scale and Doppler gain to obtain an optimal Doppler trace. Only if maximum Doppler gain does not create an acceptable image does the operator increase output. PW Doppler can be used to assess blood flow in the later stages of the fetal development.

CARDIAC

For cardiac imaging, the clinician starts with selecting the appropriate transducer (P5-1X for basic non invasive transthoracic cardiac imaging, through the General application) and the appropriate Tissue Preset Setting (Cardiac for P5-1X). The clinician then starts imaging the heart and adjusts the output power to ensure that the lowest possible setting is used to obtain an adequate B Mode image. After the first B Mode image is obtained, adjusting the depth and spread of the focal zone, and then increasing the receiver gain should be used first to produce a uniform representation of the heart in one of the typical view. If an adequate image can be obtained with the increase in gain, then a decrease in output should be made. Only after making these adjustments should the operator increase output to the next level, if ever needed. Having acquired the B Mode images of the heart, CFI, CPI and/or dCPI can be used to localize and assess blood flows. As with the B Mode image display, gain and image processing controls must be optimized before increasing output. In case of artifacts due to the increase in gain, the user shall activate the Flash suppression key to be able to increase gain and decrease output acoustic power. Having acquired B Mode and Color Flow, the user can image the heart using M-Mode imaging. M-Mode can be used clinically for the assessment of valve motion, chamber sizes, aortic root size, wall thickness, and ventricular function. M-mode pulses a narrow ultrasound beam in a single plane through the heart, producing images of the tissue in that plane with a very high temporal and spatial resolution. It can also be used to assess the beats per minute of cardiac activity. Before increasing

output, the user should first adjust the appropriate B/M Modes parameters such as gain, maps, and dynamic range; adjust the size and location of the M zone to obtain an optimal M-Mode trace. Only if maximum M-Mode gain does not create an acceptable trace does the operator increase output. Having localized the blood flow, the operator also has the ability to use the Pulsed Wave (PW) Doppler Mode and adjust its controls to position the sample volume over the characteristic cardiac blood flows to be analyzed. This technique allows for the localization of the Doppler shift, and hence velocity or pressure measurements. Before increasing output, the user shall adjust velocity range or scale and Doppler gain to obtain an optimal Doppler trace. Only if maximum Doppler gain does not create an acceptable image does the operator increase output. While evaluating cardiac blood flows using the Pulsed Wave Doppler Mode, The operator has the possibility to assess Tissue Motion velocities using Pulsed Wave Tissue Doppler Imaging (PW TDI) by positioning the PW TDI sample volume over the Left Ventricle walls in the apical window, especially at the Mitral annulus. Before increasing output, the user shall adjust velocity range or scale and Doppler gain to obtain an optimal Tissue Doppler Imaging trace. Only if maximum Tissue Doppler Imaging gain does not create an acceptable image does the operator increase output. Having localized the blood flow, the operator also has the ability to use the Continuous Wave (CW) Doppler Mode and adjust its controls to position the sample volume over the characteristic cardiac blood flows to be analyzed. This technique allows for assessment of the Doppler flow characteristics along the CW Doppler line, and hence velocity or pressure measurements. Before increasing output, the user shall adjust velocity range or scale and Doppler gain to obtain an optimal Doppler trace. Only if maximum Doppler gain does not create an acceptable image does the operator increase output.

PEDIATRICS

For any pediatric exam, the clinician starts with selecting the appropriate transducer (superficial Pediatric on the L18-5, L10-2, LH20-6 or MC12-3 and deep Pediatric on the MC12-3) and appropriate application and Tissue Preset Setting (Neonatal Head, Thyroid Neck, Abdomen, Hip, Scrotum, Superficial or Pelvic Gyn) the clinician starts imaging the tissue and starts adjustments of the output power to ensure that the lowest possible setting is used to obtain a B Mode image. The user shall then adjust the spread and depth of the focal zone of the transducer, and then using the AutoTGC key or increasing the receiver gain to produce a

uniform representation of the tissue follows. If an adequate image can be obtained with the adjustment/ increase in gain, then a decrease in output should be made. Only after making these adjustments should the operator increase output to the next level in the case of an unsatisfying image. Having acquired the B Mode images of the Pediatric tissue, CFI CPI and/or dCPI can be used to localize blood flow. As with the B Mode image display, gain and image processing controls must be optimized before increasing output, if ever needed. Having localized the blood flow, the clinicians shall use the Pulsed Wave Doppler controls to position the sample volume over the vessel. Before increasing output, the user shall adjust velocity range or scale and Doppler gain to obtain an optimal Doppler trace. Only if maximum Doppler gain does not create an acceptable Doppler spectrum does the operator increase output. Having acquired 2D, Color Flow and Pulsed Wave Doppler, Elastography can be used to assess the tissue stiffness. SWE Opt. setting (Resolution, Standard or Penetration), size and location of the SWE Box and SWE gain shall be adjusted to obtain an optimal Elastography image before increasing output. Only if optimal settings and maximum Elastography gain do not create an acceptable image does the operator increase output.

Security Management

Below are some information that SuperSonic Imagine has performed and implemented to help secure the Aixplorer® Mach 30:

All unnecessary communication ports and all Remote logging services are disabled.

Only the DICOM port remains opened (Port 11112 by default).

System is designed according to the principle of least functionality: only DICOM services are available. A system of white list can be activated: only declared server can push object to the Aixplorer® Mach 30 system.

1. All operating system services that are not used by the ultrasound system application software are disabled to minimize the sources of security vulnerabilities. The system provides only essential capabilities: The use of non-essential functions, ports, protocols and services is prohibited or restricted to prevent unauthorized connection of devices, unauthorized transfer of information, or unauthorized tunneling.
2. Healthcare delivery organizations can utilize network scanning tools, intrusion detection and prevention systems to identify and prevent the use of prohibited functions, ports, protocols, and services.

The user interface does not allow users interacting with the operating system. There is no access for a user to the underlying operating system, which prevents the user from introducing viruses or malwares. The user has only access to the ultrasound interface controls. User can not load software, open email, or browse internet.

The “auto run” feature is disabled on the Aixplorer® Mach 30 system. The Aixplorer® Mach 30 system will not open or run a program available on CD/DVD or USB memory stick inserted in Aixplorer® Mach 30.

SuperSonic Imagine is monitoring security breaches; Should a security problem be discovered, the customer will be notified and a cybersecurity patch will be provided.

It is possible to anonymize images before export, however anonymization of “image pixel data” is ultimately the responsibility of the anonymization site even if “applications” are used to anonymize the data. Anonymization of data burned into the image itself (ie, image pixel

data) is notoriously difficult. Review of all such images for accurate anonymization is strongly recommended when such images are batch anonymized by computer application.

In order to minimize the consequences of any security event, SuperSonic Imagic strongly recommends to send images to a PACS.

To ensure patient and user data protection, it is necessary to use secured tools for any data sharing containing Protected Health Information (PHI). E-mails and non-secured data hosting services do not guarantee an effective protection of data.

Recommendations regarding use of USB devices

To mitigate the threat of a potentially infected thumb drive plugged on Aixplorer® Mach 30, the following measures should be taken at a minimum:

- Ensure the use of approved, trusted vendors for hardware purchases.
- Scan all hardware, especially removable storage media, on an external system prior to its insertion into Aixplorer® Mach 30
- Users should protect themselves and organizations by practicing good browsing habits, ensuring they do not respond to or click on unsolicited email, and to not plug unknown USB devices into their workstations.
- If you don't have the expertise to properly handle or identify potential cyber threats please seek out an expert who can provide the expertise needed to secure your organization.

Alert system

The usage of the Aixplorer® Mach 30 ultrasound system requires the physical presence of the operator. The operator and patient are co-located to the system. Thus the Aixplorer® Mach 30 alert system is composed of visual alerts only. The Aixplorer® Mach 30 alert system utilizes either a pop-up window with suggested actions or a message in the information area of the main monitor. The Aixplorer® Mach 30 alert conditions are not configurable by an operator. The Aixplorer® Mach 30 logs the occurrences of alerts for later review by a SuperSonic Imagine representative.

The medium priority alerts are used to intervene automatically by halting the system upon detection of an alert condition that may result in harm to the patient, operator, or the system. The operator is instructed via a visual alert. The course of operator's actions is limited to contacting an SuperSonic Imagine representation and acknowledgement of the restarting the system.

The low priority alerts are used as informational. The user may be able to take action to resume system usage or the alert is strictly to inform the user of a condition that may impact workflow.

The following alerts display pop-windows of a medium priority:

Table 3.5. Medium priority alerts

Alert	Title/message
HARDWARE ALERT	
HAL_ERROR_API	A problem in acoustic power intensity computation has occurred API error: please reboot and contact a SuperSonic Imagine representative
Default case	Hardware control alert
	Hardware controller board alert
HAL_ERROR_LOADING_SEQUENCE	A problem has occurred during sequence loading
SOFTWARE ALERT	
HWC_SP_MAY_HAVE_DIED	Hardware error: reboot is required Please contact a SuperSonic Imagine representative
MGR_PROCESS_DEAD	An error occurred, the system will restart
MGR_PROCESS_NO_RESPONSE	Process processName not responding, wait a few seconds or force restart
HWC_OSAWA_WATCHDOG_USB	OSAWA watchdog error
HWC_SHORT_CIRCUIT	Short circuit error
HWC_US_BOARD_OVERHEAT	US board overheat
HWC_VOLTAGE_ERROR	Voltage error
HSPM_SOFTWARE_ERROR_SEIJI_ACCESS	SEIJI communication error
HSPM_SOFTWARE_ERROR_LOG_PROM_WRITE	Log EEPROM write error
HSPM_SOFTWARE_ERROR_LOGGING_INFORMATION	Log EEPROM logging information error
HSPM_SOFTWARE_ERROR_OSAWA_ERROR	OSAWA access error
HSPM_SOFTWARE_ERROR_MGR_MSG_TIMEOUT	Manager keep alive timeout
HSPM_SOFTWARE_ERROR_MGR_MSG_SEND_ERROR	Manager message send error
HSPM_SOFTWARE_ERROR_HSPM_START_ERROR	HSPM start error
HSPM_SOFTWARE_ERROR_OSAWA_WATCHDOG_ENABLE	OSAWA watchdog enable error
HSPM_SOFTWARE_ERROR_OSAWA_WATCHDOG_DISABLE	OSAWA watchdog disable error
HSPM_SOFTWARE_ERROR_EVENT_SERVICE_NOT_OPEN	SSI event service not opened
HSPM_SOFTWARE_ERROR_TEMPERATURE_SENSOR	Temperature alert
HSPM_SOFTWARE_ERROR_ECG	ECG monitoring error
MEAS_INVALID	ERROR

The following alerts display pop-windows of a low priority:

Alert	Title/message
SOFTWARE 3D ERROR	
E3D_CONTROLLER_ERROR_CONNECTION_INIT	The 3D controller is not connected
E3D_CONTROLLER_ERROR_NOT_CONNECT	
E3D_CONTROLLER_ERROR_NOT_GOOD_VERSION	The 3D controller is not identified
E3D_CONTROLLER_ERROR_USB_NOT_CONNECTED	The 3D motor controller USB is unplugged
E3D_CONTROLLER_ERROR_TIMEOUT	The 3D controller is not responding
E3D_CONTROLLER_ERROR_NONE	Try to change acquisition parameters
N/A	Try a new 3D acquisition
HARDWARE ALERT	
HAL_ERROR_IRQ_TIMEOUT_DMA_EXPORT	You may unfreeze to continue. DMA Sequencing warning - 0x000001
HAL_ERROR_IRQ_TIMEOUT_DMA_IMPORT	You may unfreeze to continue. DMA Sequencing warning - 0x000003
HAL_ERROR_IRQ_TIMEOUT_OTHER	You may unfreeze to continue. DMA Sequencing warning - 0x000003
HAL_ERROR_IRQ_TIMEOUT_TRIGGER	Press a mode button to continue. Trigger timeout - 0x000004
HAL_ERROR_INVALID_SQL	You may unfreeze to continue. DMA warning: invalid SGL Handle
HAL_ERROR_MAIN_LOOP_LOCK_TIMEOUT	You may unfreeze to continue. HWC main loop lock timeout
SOFTWARE ALERT	
COMPLUT_ALERT	Internal reconstruct LUT error
REVIEW_IMAGE_NOT_FOUND_ALERT	Review error: image cannot be loaded due to corrupted data
US_XML_VALIDATOR_ALERT	XML validator error: please contact an ultrasound engineer
MEAS_WARNING	ERROR
CONNECT_TOO_MANY_JOB	The job list contains more than 50 pending jobs. Please select and delete these jobs manually from the job list.
CONNECT_TOO_OLD_JOB	The job list contains some pending jobs older than one week. Please select and delete these jobs manually from the job list.
MGR_ENGINEERING_RELEASE	The software release that is currently running on your Aixplorer system is an engineering release that is not approved for human diagnosis.
ERROR_USB_TRANSFER	ERROR while transferring data to USB device
NOT_ENOUGH_SPACE	WARNING HARD DISK ALMOST FULL Please delete data on your system.
PARAMETER_BAD_USE	US parameter bad use

4 Getting Started

Conventions

Conventions used in this user's guide

This user's guide uses the following conventions:

All procedures are numbered. You must complete steps in the sequence they are presented to ensure a correct result.

Bulleted lists indicate general information about a particular function or procedure. They do not imply a sequential procedure.

Control names, menu items and/or titles are spelled as they are on the system.

Symbols appear as they appear on the system.

The left side of the system is to your left as you stand in front of the system, facing the system.

Touch means to press a button on the touch screen.

Conventions used in the system

These conventions are used in the system:

The software that runs the system uses graphic display elements similar to those used in many personal computers.

On a menu, or other display, a highlight bar indicates that the item or name contained within the boundaries of the highlight bar is in the process of being selected.

Performing a click on the **SonicPad®** actually selects the item, assigns a value to a system parameter, or initiates the action related to the selected item.

To enter text into a text field, move the cursor to the field and use the touch screen keyboard.

To display a list, click the down arrow.

To scroll through a list, make sure the cursor is over the list. Then use two fingers to scroll. Moving your fingers down scrolls down a list, moving your fingers up scrolls up a list.

Knobology

General information

The control panel includes the SonicPad® and controls such as buttons, knobs, and knob-buttons.

Press a button to activate or deactivate its function.

Turn a knob to change the selected setting.

Press a knob-button to activate its function. When a knob-button is associated to a value, turn it clockwise to increase the value of the settings or turn it counterclockwise to decrease the value of the settings (unless configured differently in System configuration).



NOTE

Pressing on buttons related to options that are not available will have no effect.

SonicPad®



The SonicPad® allows you to move the cursor and navigate in the system. It also allows you to perform basic actions and measurements during exams by means of gestures.



NOTE





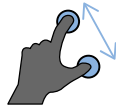

The SonicPad® is designed to be used while wearing gloves and while being covered during an interventional procedure.



The following table indicates how to perform the different gestures mentioned in this User's Guide (unless configured differently in the System configuration):

Gesture name	How to perform the gesture
Click	 Click on the SonicPad®
Swipe	 Move your finger(s) vertically or horizontally
Pinch/Spread	 Do a pinch or spread gesture using 2 fingers

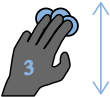
The following table lists the main gestures available by default (unless configured differently in System configuration):

Controls	Associated gesture
Select/Click	 Click with 1 finger

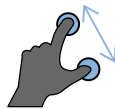
Controls	Associated gesture
Freeze	 <p>Click with 2 fingers</p>
Clip navigation	 <p>When in frozen mode:</p> <ul style="list-style-type: none"> • Swipe right with 2 fingers to navigate the clip forward • Swipe left with 2 fingers to navigate the clip backward
Save image	 <p>Click with 3 fingers</p>
Save clip	 <p>Click with 4 fingers</p>
Depth	 <p>Swipe up with 3 fingers to decrease the depth Swipe down with 3 fingers to increase the gain</p>
Gain	 <p>Swipe right with 3 fingers to increase the gain Swipe left with 3 fingers to decrease the gain</p>

Controls	Associated gesture
Zoom	 <p>Pinch with 2 fingers to decrease the zoom Spread 2 fingers to increase the zoom</p>
Move a box	 <p>Swipe 1 finger in the desired direction</p>
Arbitration	 <p>Swipe left or right with 4 fingers to change horizontal arbitration</p>



NOTE

Make sure your fingers are placed on the SonicPad® before performing any clicks.

A gesture reminder area is available by clicking on the gesture icon on the touch screen (see picture below).

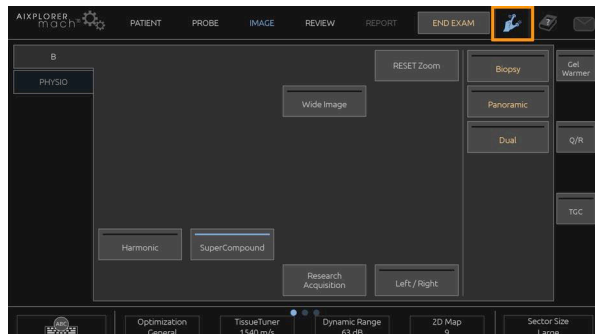

The reminder is now displayed on the main monitor.



These gestures are entirely customizable in System configuration, please refer to [Chapter 9, Customizing the System \[355\]](#) for more information about gesture customization.

Please refer to [the section called “Common Imaging Controls” \[180\]](#) for more information about each control/gesture combination.

Customizable buttons

Control panel buttons are customizable according to your needs.

You can assign functions that are not available on the control panel to S1 and S2 buttons in the System configuration.

You can also switch button location to your convenience by doing the following: Put a screwdriver in one of the small notches located on each side of the buttons to remove them, then put them at the desired location.



CAUTION

After changing button location, make sure the button is well pushed in its compartment.

Make sure to correctly assign the software functions to the control panel buttons in the System configuration.



NOTE





You can adjust the control panel brightness in **System Configuration**, **System** sub-tab.

Please refer to the [Chapter 9, Customizing the System \[355\]](#) for more information about customizable buttons.

Touch screen

The touch screen contains several types of controls, depending on the function to perform.

Touching this type of control...	... triggers this event
	Touch a tab to display a different imaging mode menu.

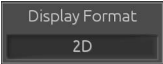
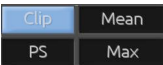
Touching this type of control...	... triggers this event
	Touch to open a particular page or function. Touching the Keyboard control in this example displays the keyboard.
	Touch to turn a function On or Off. The LED button is blue when the function is on, and dark blue when it is Off.
	Touch to change the value displayed on the button. Repeatedly pressing this type of button cycles through all the values. The value displayed is indicated by the position of the orange mark.
	Rotate the knob located below the touch screen label to change the value.
	Touch to change the value displayed on the button. The value displayed is indicated in the box.
	Touch the appropriate part of the button to change its value.



NOTE

You can adjust the touch screen brightness in **System Configuration**, **System** sub-tab.

Getting started

Turning the system ON and OFF

The system can be set to two different power modes: ON and OFF.

Turning the system ON

1. Press **I** on the switch located at the rear of the cart.



Powering the system up

1. Press the **On/Off** button on the control panel.



The system automatically checks a certain number of components and peripherals and boots up.

Powering the system down

1. Press the **On/Off** button on the control panel.
2. The shutdown menu appears.
3. Select **Yes**.

Turning the system OFF

1. Press **O** on the switch located at the rear of the cart to complete the shutdown of the system. If some elements are still in queue to be exported, a pop is displayed.

By default, the remaining jobs will restart at next start of the system. If you want to cancel the remaining jobs from the system, uncheck the box before shutting down the system.

When set to OFF, the system consumes no power. To achieve a balance between convenience and energy efficiency, follow these recommendations:

- If the system will not be used overnight, switch the system to Off at the end of the day. Press the On/Off switch above the control panel to turn the system off.
- If the system will not be used for longer than overnight, power the system down. Press the On/Off button on the control panel to power the system down.

Always use the procedures listed here for turning off the system, if possible.

Turning off the system in any other way will result in longer initialization time when the system is turned on again, and may cause other problems.



CAUTION

Turn on the system only after the power has been off for more than 15 seconds. If the system is turned on immediately after being turned off, the system may malfunction.

If power cannot be turned off by the normal procedure, press and hold down On/Off for at least 5 seconds. If the power is still not turned off, turn off the switch of the power supply panel at the rear of the system.

These methods should not be used under normal conditions. They may damage the system.

If the power is not turned off by following the normal procedures, B-mode images may not be displayed when the system power is turned on again. This does not indicate system failure. Turn off the switch on the power supply panel on the rear of the system, wait at least 15 seconds, and then turn the system power on.

Never shut down the system while files are being transferred. Data corruption or loss may result. In case of power failure or if the system

is unplugged during use, the Aixplorer® Mach 30 will run on battery to protect the system. It is recommended to properly close the current exam before complete shutdown. When the system is running on battery, the control panel on/off button is blinking.

Setting the time and date

The system includes a clock/calendar function, which maintains accurate time and date even when the system is turned off and disconnected from power.

Refer to the [Chapter 9, Customizing the System \[355\]](#) for instructions on setting up time and date.

Setting the language

You can configure the system user interface language and regional parameters in the system configuration.

Refer to [Chapter 9, Customizing the System \[355\]](#) for instructions on setting up the language.

Getting connected to a network

The system supports standard network functions, which include printing to DICOM printers, local printers and report printers (options).

Refer to [Chapter 9, Customizing the System \[355\]](#) for instructions on network configuration.

Selecting a transducer

The system uses four ports for connecting transducers that can be occupied at the same time, but only one transducer can be active at a time.

Always use the cable management system to prevent cables from being stepped on or run over by the cart wheels.

Connecting a transducer

See [the section called “Connecting a Transducer” \[29\]](#).

Selecting a transducer for an exam

When the system is turned on, the system defaults to the last used transducer, application and preset.

It is possible to select among the four connected transducers during system operation.

1. Press **Probe** on the touch screen.

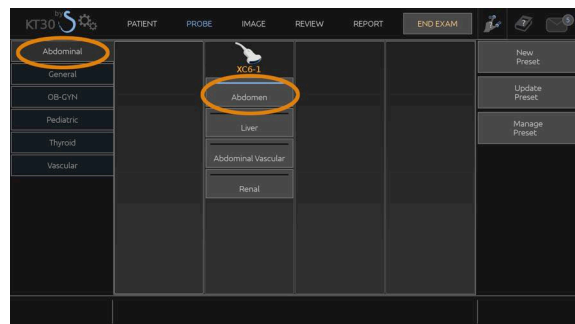

The touch screen will display the applications that are compatible with the transducers that are connected to the system

2. Touch the **tab** corresponding to the desired clinical application.

Ex: Vascular

The touch screen will display the probes you can use for the selected application, and the associated Presets.

3. Press the desired **Preset**.

Ex: Carotid

The Probe touch screen closes and the system is in live B-mode.

The factory presets appear in darker blue and the user-created presets appear in lighter blue.



NOTE

It is possible to customize the displayed list of presets in the system configuration. Refer to the [Chapter 9, Customizing the System \[355\]](#)

The selected transducer, application and preset appear on the header of the imaging main display.



WARNING

Use only recommended gels (lubricants). Alternate products can damage the probe and void the warranty.

Beginning an exam

Getting ready

Before acquiring images, you may want to create a patient exam or retrieve a patient you already created in the system.

Before scanning a new patient, make sure the previous exam has been ended, by doing one of the following:

- Press **End Exam** on the touch screen.
- Press **New Patient** on the touch screen.

Creating a new patient

PATIENT DATA ENTRY

1. Press **Patient** on the touch screen.

The Patient Data Entry is displayed on the main screen.

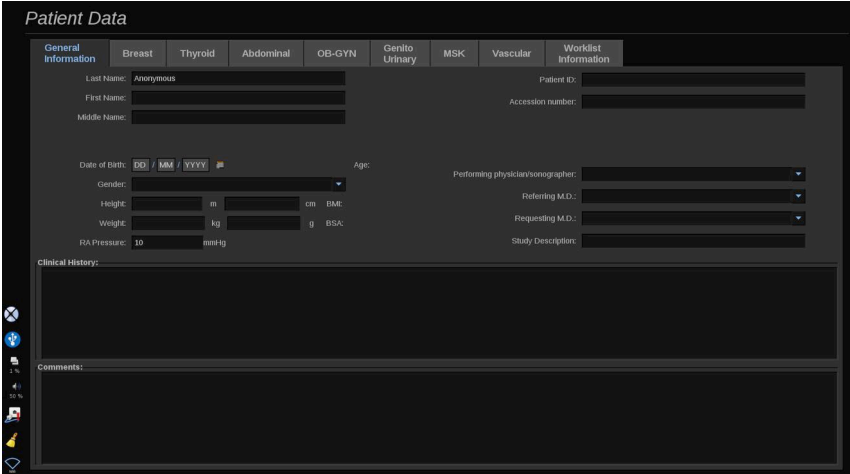

The screenshot displays the 'Patient Data' form with the 'General Information' tab selected. The form includes fields for Last Name (Anonymous), First Name, Middle Name, Patient ID, and Accession number. It also features dropdown menus for Gender, Performing physician/sonographer, Referring M.D., and Requesting M.D. Physical attributes like Date of Birth, Height, Weight, and RA Pressure are also present. A 'Clinical History' section and a 'Comments' field are located at the bottom of the form.

The **General Information** tab of the Patient Data Entry gathers the fields related to the patient identity.

The **Worklist** Information tab of the Patient Data Entry displays information coming from the Modality Worklist (if associated and configured).

Eight other **tabs** are available, each of them displaying specific clinical information:

- Breast
- Thyroid
- Abdominal
- OB-Gyn
- Genitourinary
- MSK
- Vascular

- Cardiac

To navigate through the tabs, move the cursor to the tab you want to open and click on the **SonicPad®**.

To enter new data, place the cursor in the field you want to fulfill. The active field is automatically highlighted in orange.

Type the desired text with the keyboard. You can visualize the text you are currently typing directly on the touch screen, in the preview area.

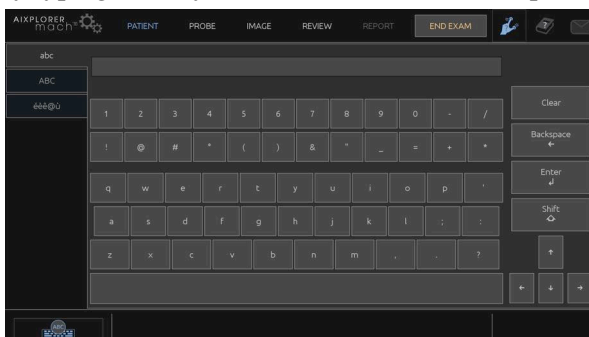

NOTE

Patient ID: The system uses a unique ID to identify each patient. You may enter your own ID, or the system will create one automatically.

Images and reports are stored based on the patient ID.

The name and ID appear at the top of all image displays.

The ID can be also obtained by the barcode reader.



CAUTION

For obstetrical exams:

Be careful to confirm the patient name and ID before starting an examination for a new patient.

Check the date format before entering date of birth, Last Menstrual Period (LMP), Estimated Date of Delivery (EDD), Date Of Conception (DOC)

and Ovulation Date. Incorrect entry of these parameters will result in an incorrect Gestational Age (GA).

Enter the EDD and GA in the patient's medical record for backup. Check the "Activate OB calcs" button on the Patient Data Entry page (PDE) in order to perform obstetric calculations.

It is necessary to specify which OB author is to be used for each particular measurement to calculate the GA and get an Estimated Fetal Weight (EFW).

A diagnosis can not be only based on one measurement or data. Be careful to always consider the overall clinical evaluation of the patient, including the medical record.

Depending on fetal position, some measurements may be incorrect. Be careful to always consider the overall clinical evaluation of the patient, including the medical record.

The system provides fetal measurements for up to five fetuses. Be careful not to confuse the fetuses during measurements.

For each measurement performed, you can select either the first, last, average, minimum, maximum or specifically one of the five measurements that are allowed to be displayed, using the selector feature in the Measurements tab of the Report.

Be careful when deleting measurements, as this will affect the selector result.

Deviations from the normal values of measurements must be judged based on the graphs and literature.

To choose a value in a list

1. Move the cursor to the arrow on the right of the drop-down list.
2. Click to display the list.
3. Move the cursor down to the selected value and click again to validate your choice.

You can save the Patient Data Entry as an image of the exam.

To do so, press **Save Image** while in the Patient Data Entry.

This will save the active tab as a screenshot.

LOADING A PATIENT FROM THE MODALITY WORKLIST

Finding exams in the Worklist

This feature is available if the system is connected to the network and the DICOM feature is enabled.

1. Press **Patient** on the touch screen.

The Patient Data Entry is displayed on the main screen.

The Patient touch screen is now displayed.



NOTE

If a Modality Worklist is configured and associated, pressing **End Exam** will automatically display the Modality Worklist (if configured).

2. Touch **M.Worklist** on the touch screen.

The modality worklist is displayed on the main screen.



NOTE

Check the boxes above the list to filter it.

Place the **cursor** over a column header and then press click on the **SonicPad®** to sort the list by the selected column.

Use the search box to find a given patient.

3. Move the cursor over the patient file you want to open.
4. Click on the **SonicPad®**.

The Patient Data Entry is displayed on the main screen and pre-populated. You can edit some of the information for this patient. See [Chapter 9, Customizing the System \[355\]](#) for more information on how to configure the Modality Worklist.

Broad query, patient query

Aixplorer® Mach 30 offers the two types of queries defined by the IHE (Integrating the Healthcare Enterprise): broad queries and patient queries.

By default, the Worklist performs broad queries.

Patient Query limits the number of answers that are returned, and therefore increases the confidentiality, limits the risk to select by mistake the wrong patient in the worklist, and limits the quantity of data to be transferred to the system.

To use Patient Query:

1. Press **Patient Query** on the touch screen to perform a query on a specific patient only. Use this mode especially if your network is slow. A window pops up.
2. Enter data for the specific patient you want to retrieve on the worklist. At least one mandatory field must be filled in to perform the query.
3. Click on **Query** to perform the query on the specific patient.

Press **Broad Query** on the touch screen to switch to the Broad Worklist query mode. The Modality Worklist can be used when the system is disconnected from the network. See [Chapter 9, Customizing the System \[355\]](#) for more details.

EDITING PATIENT DATA

Editable data

Data may be edited for the current patient. Some information can be edited at any time during an exam, if not imported from the Modality Worklist.

To edit patient data

1. Place the text cursor in the field you want to edit. The active field is highlighted in orange.
2. Type the new text with the keyboard.

If you edit one of the identifier fields, a pop up message is displayed. Press Yes to confirm or No to cancel.

The identifier fields are the following:

- Patient Last Name
- Patient First Name
- Patient Middle Name
- Patient ID
- Accession Number
- All the fields in the DICOM tab of the Patient Data Entry

If you edit one of the fields listed above AFTER the exam was sent to a server, the DICOM store may start a new exam with the new patient information. Entering the patient's height and weight automatically calculates the Body Mass Index (BMI).

Ending an exam

Make sure all the images you need are saved. After the exam is complete, end the exam as follows: Press End Exam on the touchscreen.

Imaging modes

General information on imaging modes

Entering/exiting modes

The Aixplorer® Mach 30 ultrasound system offers a set of imaging modes via the mode selection buttons. On the control panel, the mode buttons are located above the SonicPad®.



- Press B to scan in grayscale B-mode.
- Press M to access M-mode.
- Press SWE™ to scan in grayscale B-mode with a real-time color elasticity map superimposed.
- Press COL to use Color Flow Imaging (CFI), Color Power Imaging (CPI), or Directional Color Power imaging (dCPI)

- Press PW to use Pulsed Wave Doppler
- Press CW to use Continuous Wave Doppler.
- Press CEUS to use Contrast Enhanced Ultrasound imaging

Access to 3D is given on the touch screen.

In any mode other than B-mode, whenever the B key is pressed, the current mode is exited and B-mode is displayed. The previous settings are restored.

5 Imaging

About System Display

About the Imaging Main Display

The imaging main display contains an ultrasound image, the exam and image information and some indicators.

The image area is located approximately in the center of the imaging display.

To the right of the image itself are a depth scale and a grayscale bar and/or color bar.

Patient and exam data are displayed in the area directly above the ultrasound image. This area also includes the current time and date, the institution name, the selected transducer and clinical application, the Thermal Index (TI) and Mechanical Index (MI) values.

Image parameters are displayed on the left of the image.

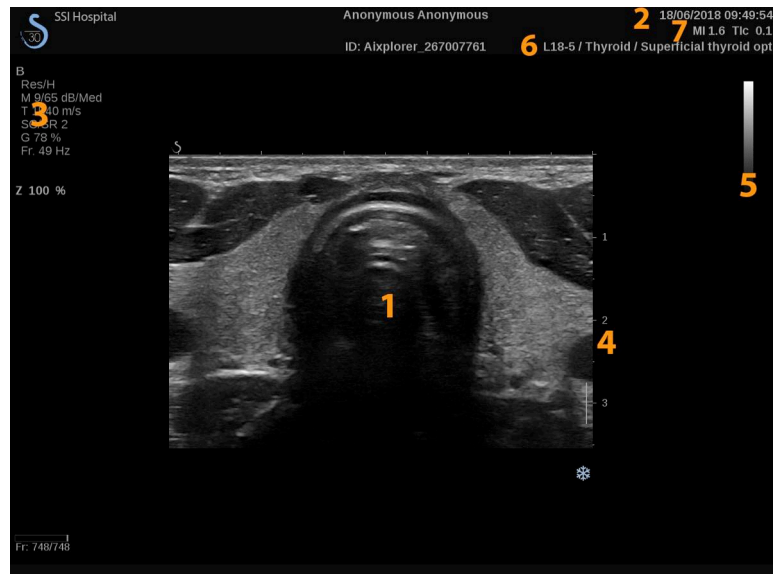















- | | |
|---------------------|----------------------|
| 1. Ultrasound image | 2. Patient/Exam data |
| 3. Image Parameters | 4. Depth scale |
| 5. Grayscale bar | 6. Transducer/Preset |















7. MI and TI





Refer to each mode for a detailed description of each imaging main display.

Notification Icons

Some icons appear at the bottom left of the main display to inform you about the state of the system.

Icon	Meaning
	There is a CD in the CD/DVD drive
	The system is burning a CD
	Error during CD burning
	There is a DVD in the CD/DVD drive
	The system is burning a DVD
	Error during DVD burning
	No CD or DVD in the CD/DVD drive
	There is a USB device plugged in
	The system is exporting data to a USB device
	Error during USB export
	The system is connected to a network
	Network error
	The system is exporting data to a DICOM store SCP
	Error with the DICOM Modality Worklist SCP

Icon	Meaning
	Error with the DICOM Store SCP
	The system is printing to a DICOM printer
	Error with a DICOM printer
	Error with a DICOM commit server
	The system is printing to a local printer
	Error with a local printer
	Modality Performed Procedure Step (MPPS) is busy
	Error with MPPS
	DICOM Modality Worklist is refreshing
	Error with DICOM Modality Worklist
	DICOM Modality Worklist: Offline mode
	DICOM Modality Worklist filtered
	Check the air filters
	Available storage on the hard drive. Do not try to acquire more data if the hard drive is full.
	Query and Retrieve

Icon	Meaning
	WIFI is deactivated
	WIFI is connected. No signal
  	WIFI is connected. Signal intensity levels
	A notification icon indicates that a remote service connection is active
	A notification icon indicates when an update is available
	A notification indicates the status of transfer progress
	A notification icon indicates when logs monitoring is in progress
	A notification indicates when logs upload is in progress
	A notification indicates the connexion status (ie SSI logs servers reachable)
	A notification icon indicates that a remote service connection is active

About the Imaging touch screen

The imaging touch screen varies according to the scanning mode.

It contains:

- permanent controls available in all imaging modes
- imaging parameters that are related to the current active mode(s)
- rotary controls that can be used with their corresponding knobs, located under the touch screen
- Additional rotary controls may be available at the bottom of the touch screen by swiping with one finger.

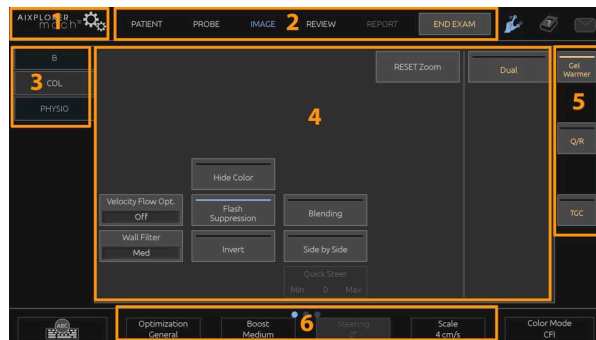

- | | |
|-------------------------|-----------------------|
| 1. System Configuration | 2. Workflow Menus |
| 3. Imaging mode tabs | 4. Imaging Parameters |
| 5. Permanent Controls | 6. Slidable Bar |

Common Imaging Controls

Some controls are common to all imaging modes. These controls are detailed below.

For a description of controls specific to each imaging mode, refer to the detailed section on each imaging mode.

Freeze

When in Live imaging, press **Freeze** on the control panel to freeze the image. A snowflake appears on the image to indicate the image is frozen. When the image is frozen, press **Freeze** to unfreeze the image and return to live imaging.



TIP

You can Freeze and unfreeze the image by using the SonicPad®. Click with two fingers on the SonicPad® (unless configured differently in System configuration) to freeze the image.

Depth

Depth controls the distance over which the B-mode displays anatomy.

When you increase the depth, you capture echoes from deeper in the body. Therefore, it takes longer for the transducer to receive all the signal. The receive time is increased and there is more information to process. The time between two ultrasound beams is increased.

As a result, the frame rate is decreased.

Depth is located on the control panel and adjustable only in live imaging.

Rotate **Depth**:

- clockwise to increase the depth and visualize deeper structures
- counterclockwise to reduce the depth and focus on shallower structures.



TIP

You can increase or decrease the depth by using the SonicPad®. Swipe up with three fingers to decrease the depth, or swipe down to increase the depth (unless configured differently in System configuration).

Gain

Overall gain increases or decreases the amount of echo information displayed in an image.

It may have the effect of brightening or darkening the image if sufficient echo information is generated.

Gain is adjustable in live imaging and on a frozen image.

Gain is adjustable in all modes with each mode knob.

Rotate **B**, **M**, **SWE™**, **COL** or **PW** according to the active mode:

- clockwise to increase the overall gain in order to obtain a brighter image
- counterclockwise to decrease the overall gain in order to obtain a darker image.

To increase or decrease CW gain, rotate the PW button.



TIP

You can increase or decrease the gain by using the SonicPad®. Swipe right with three fingers to increase the gain, or swipe left to decrease the gain (unless configured differently in System configuration).

Time Gain Compensation (TGC)

Auto

Auto automatically adjusts the B-mode gain at different depths and for different tissue attenuations.

Overall brightness is automatically adjusted depending on setting of **Auto Offset** (see [the section called “Auto Offset” \[194\]](#)).

Auto is located on the control panel.

Press **Auto**. If needed, you can make independent gain adjustments (see [the section called “Gain” \[182\]](#) above).



NOTE

While in PW or CW mode, press **Auto** to automatically adjust the **Scale** and **Baseline**. See [the section called “Setting Up PW” \[228\]](#)

Adaptive TGC Mode

Turning this mode **On** enable the automatic TGC adjustments when changing the imaging controls. To activate or deactivate it, see [the section called “System” \[358\]](#)

ManualTouchTGC™

You can selectively adjust the uniformity of brightness throughout the image.

Press **TGC** on the touch screen.

The B-mode image is simultaneously displayed behind the slide pods.

Draw the TGC curve as needed with a stylus or finger.

You can also change the position of each virtual control on its line by touching another place on the same line.

Focal Zone Management

The focal zone is the depth at which the lateral resolution is the best on the image.

The focal position is the depth at which the transmitted ultrasound energy is focused.

You can choose the Focal Zone Management to be Manual or Automatic.

You can control this setting in the System/Display sub-tab System. See [the section called “System” \[358\]](#)

Manual Focal Zone Management

By selecting manual, you will be able to define and manage the Focal zone and position.

Focus is adjustable only on live imaging.

Focus is located on the control panel.

Rotate **Focus**:

- clockwise to place the focal zone deeper
- counterclockwise to place the focal zone at a shallower depth

Press **Focus** and then rotate it:

- clockwise to increase the size of the focal zone
- counterclockwise to decrease the size of the focal zone

Press **Focus** again to move the focal zone.

Changing the size of the Focal Zone affects the frame rate.

The larger the Focal Zone, the slower the frame rate.

Automatic Focal Zone

By using the automatic option, the Focal Zone will be automatically managed to provide the most appropriated focal zone size and position. The ratio between the Focal Zone size and depth will be maintained and the Focal Zone position will be adjusted within any depth change.

Zoom

A region of interest in imaging modes can be magnified for closer examination. Two types of zoom are available on Aixplorer® Mach 30: HD Zoom and Digital Zoom.

HD Zoom

HD Zoom concentrates the system acquisition and processing ability on a specific region of interest in the real-time image display.

The result is a reduced field of view overall, but greater detail and higher frame rate, which contribute to better image quality over the region of interest.

HD Zoom is adjustable only in live imaging.

To use the **HD Zoom** function:

1. Press **Zoom** on the control panel
A box appears on the image.
2. Use the **SonicPad®** to move the zoom box
3. Click on the **SonicPad®** to arbitrate to Box size
4. Use the **SonicPad®** to resize the zoom box
5. Press **Zoom** again to have an enlarged image
6. Press **Zoom** again to exit zoom

Digital Zoom

Digital Zoom is a magnifying post-processing function. As such, it has no effect on the frame rate.

Digital Zoom is adjustable in live imaging and on a frozen image.

Rotate **Zoom** to change its value.



NOTE

In live imaging, both HD Zoom and Digital zoom may be used at the same time.

Press **Reset Zoom** to set the zoom back to the preset default value.



TIP

You can increase or decrease the zoom by using the SonicPad®. Do a spread gesture with two fingers to increase the zoom, or pinch to decrease the zoom (unless configured differently in System configuration).

Left/Right

Left/Right flips the image along the left-right axis.

Touch **Left/Right** to flip the image.

Top/Bottom

Top/Bottom flips the image along the up-down axis.

Touch **Top/Bottom** to flip the image.

Dual

Touch **Dual** to activate or deactivate dual mode.

The left image will be active.

Click on the **SonicPad®** to freeze the left side and make the right side active.

Press **Freeze** to have both sides frozen.

- the active image has an orange S as the orientation marker
- the inactive image has a white S as the orientation marker

You can switch which of the dual images is active by clicking on the **SonicPad®**.

Imaging settings will always be applied to the active image in dual.

Imaging settings will be maintained independently for the dual images.

If you press **Freeze** before clicking on the **SonicPad®**, you can change image settings and modes on the active side.

Play

When the image is frozen, in all modes, a **Play** button appears on the touch screen.

Play allows you to view clips. See [Chapter 8, Image and Data Management \[333\]](#) for more information on viewing clips.

Dual Top/Bottom

Dual Top/Bottom is the same feature as **Dual Top/Bottom**, but split the screen into a top image and a bottom image.

1. Press **Dual** to enable **Dual Top/Bottom**.
2. Press **Dual Top/Bottom** to activate or deactivate the **Dual Top/Bottom** display format.

Hide Patient Name

Hide Patient Name allows you to temporarily hide the patient information from the imaging screen. However, the hidden information remain in the database.

Arbitration

If several functions are available, they are displayed at the bottom of the image. The active function is displayed in orange.

Swipe left or right with 4 fingers the active **SonicPad®** function.

Click on the **SonicPad®** to change between **Box Move** (position of the box) and **Box size** (resize the box).

Click on the **SonicPad®** to switch between **Img1** and **Img2** in dual displays.

Transducer/Clinical Applications Compatibility

The following table lists all clinical applications and transducer compatibility available with Aixplorer® Mach 30.

Clinical Application	Transducers								
	L18-5	L10-2	LV16-5	LH20-6	C6-1X	MC12-3	E12-3	C9-2X	P5-1X
Abdominal	☒	☒			☒			☒	☒
Breast	☒	☒	☒	☒					
Cardiac									☒
General	☒	☒	☒	☒	☒	☒	☒	☒	☒
Genito-urinary	☒				☒		☒	☒	
MSK	☒	☒		☒					
Ob-Gyn					☒		☒	☒	
Pediatric	☒	☒		☒	☒	☒		☒	
Thyroid	☒	☒			☒			☒	
Vascular	☒	☒		☒	☒	☒		☒	☒

B-mode Imaging

B-Mode is an ultrasound imaging mode which allows you to assess two-dimensional anatomy by displaying the echoes returning from tissues of different density in various shades of gray.

Accessing B-mode

Press **B** on the control panel from any other modes.

About B-Mode Main Display

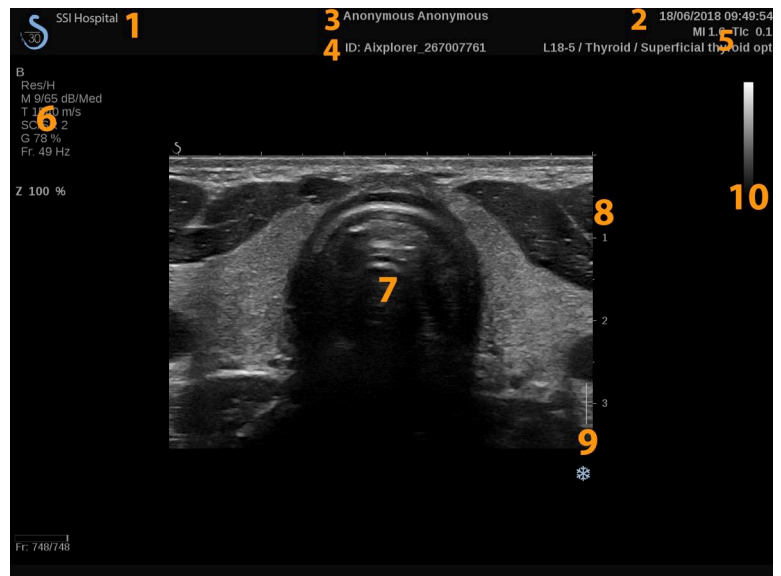

- | | |
|-----------------------------|-----------------------|
| 1. institution name | 2. date and time |
| 3. patient name | 4. patient ID |
| 5. transducer/Preset/ MI/TI | 6. imaging parameters |
| 7. ultrasound image | 8. depth scale |
| 9. focal zone | 10. grayscale |

About B-Mode touch screen

When in B-mode, the touch screen displays various image controls which help you to optimize your B-mode image.

These settings are controlled by touching the control on the touch screen, or by turning the rotary knob directly below the touch screen.

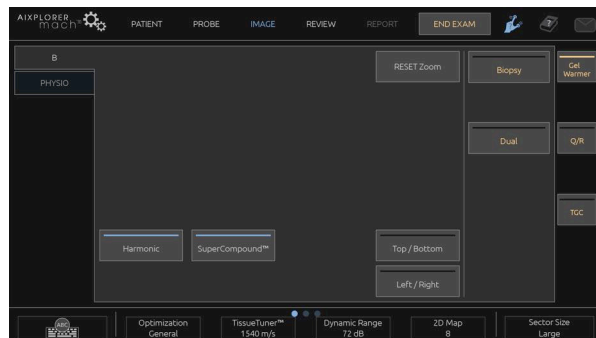

Additional rotary controls are available at the bottom of the touch screen by swiping with one finger.

Description of B-mode Imaging Parameters

Harmonic Imaging

Harmonic imaging mode is used to reduce image clutter and reverberation, and enhance borders.

Harmonic imaging is available only in live imaging.

Press **Harmonic Imaging** to activate/deactivate harmonic imaging.

Optimization

Optimization allows you to change center frequency to obtain increased resolution or increased penetration. **Optimization** is

available only in live imaging. Rotate the knob located under **Optimization** to change value:

- Resolution
- General
- Penetration

TissueTuner™

TissueTuner™ allows you to adjust the receive parameters associated with the assumed speed of sound of ultrasound in the body.

Adjusting the speed of sound parameter to match the type of tissue being interrogated results in increased spatial and lateral resolution.

TissueTuner™ is available only in live imaging.

Rotate the knob located under **TissueTuner™**:

- clockwise for a denser tissue (higher speed of sound values)
- counterclockwise for a less dense tissue (lower speed of sound values)

TissueTuner™ values depend on the selected application.

Dynamic Range

Dynamic Range allows you to change the range over which the amplitudes of returning ultrasound signals are displayed.

Dynamic Range is available in live imaging and on a frozen image.

Rotate the rotary knob located under **Dynamic Range**:

- clockwise to compress the grayscale values
- counterclockwise to decrease the dynamic range

Dynamic Range values depend on the selected application.

2D Map

2D Map assigns the display of echo amplitudes to a range of grayscale or chromatic colors.

2D Map is available in live imaging and on a frozen image.

Rotate the rotary knob located under **2D Map**:

- clockwise to view next map
- counterclockwise to view previous map

SuperCompound™

SuperCompound combines the returning ultrasound from a large number of steered echo lines to create an image which provides superior texture, enhanced edge delineation and reduces shadowing.

SuperCompound is available in live imaging only.

Press **SuperCompound** to activate or deactivate the SuperCompound mode.

Acoustic Power

Acoustic Power regulates the output power of the system.

Acoustic Power is available only in live imaging.

Rotate the knob located under **Acoustic Power**:

- clockwise to increase acoustic power output
- counterclockwise to decrease acoustic power output

Maximum acoustic power is 0dB and minimum is -30dB.

See [Chapter 3, Safety \[73\]](#) for information on output power regulations.

PRF

PRF allows you to change the pulse repetition frequency for the B-mode image.

Decreasing the PRF may correct the reverberation artefacts.

Rotate the knob located under **PRF** to change its value.

Auto Offset

Auto offset allows you to program automatic overall gain when using the **Auto**.

Auto Offset is located on the second page of parameters.

Rotate the knob located under **Auto offset**:

- clockwise if you prefer a brighter image
- counterclockwise if you prefer a darker image

Persistence

This frame averaging technique reduces noise on the image.

Persistence is available in live imaging and on a frozen image (to view clips).

Rotate the rotary knob located under **Persistence**:

- clockwise to increase persistence
- counterclockwise to decrease persistence

SuperRes™

SuperRes is an image processing feature which reduces speckle, improves image texture and enhances borders without an impact on frame rate.

SuperRes is available in live imaging and on a frozen image.

Rotate the rotary knob located under **SuperRes**:

- clockwise to increase **SuperRes**
- counterclockwise to decrease **SuperRes**

SuperRes values depend on whether **SuperCompound** is On or Off.

Sector Size

Sector Size widens or narrows the size of the sector angle to maximize the image's region of interest.

Changing the sector size affects the frame rate. The narrower the sector size, the faster the frame rate.

Wide Image

Wide Image allows you to increase the field of view.

Press **Wide Image** to activate/deactivate the wide imaging mode.

Biopsy

Biopsy guides are used to assist in the guidance of a biopsy tool. The system generates a guideline that represents the anticipated path of the biopsy tool.

See [the section called “Compatible Accessories and Kits” \[59\]](#) for the list of compatible biopsy kits.

Attaching and Removing a Biopsy Guide



WARNING

Inspect all components and the transducer.

Ensure that the biopsy guide you are using is the correct one for the transducer, the system, and system software.

Some biopsy guides must be installed over a sterile transducer cover. Refer to the instructions provided with the biopsy guide.

After each use, biopsy guides must be either sterilized or disposed of, depending upon the type. Refer to the instructions included with the biopsy guide.

Refer to the biopsy kit instructions on how to attach the biopsy guide on the probe.

Instructions for the usage of the biopsy guideline

The Aixplorer® Mach 30 generates two biopsy guide lines which are the “lines” shown on the ultrasound image. The displayed guide lines indicate the anticipated path of the needle, and should not be used as a standard in which the needle must lie within the two guide lines. Please understand that the biopsy guide lines displayed do not indicate the exact location of the needle when performing the biopsy.



WARNING

Make sure you correctly adjust the TissueTuner before performing a biopsy. The ideal TissueTuner setting results in a sharply resolved image, which improves needle guidance.



CAUTION

When the biopsy is on, the auto-freeze time is disabled in B-mode. Make sure to turn the biopsy off after the procedure is complete, to avoid damaging the probe.

The biopsy guideline's availability depends on the probe.

1. Scan in B-mode and optimize the image as needed

2. Locate the area to biopsy
3. Press **Biopsy** on the touch screen

Biopsy Angle and **Hide Biopsy** are activated (un-grayed). The biopsy guidelines appear on the screen.

1. Press **Biopsy Angle** until the desired biopsy angle is displayed on the button
2. Use the **SonicPad®** to move the biopsy target along the guidelines
3. Perform the biopsy

Biopsy Steering allows you to steer the ultrasound image in order to enhance the needle visualization during a biopsy procedure.

If the needle is introduced from the right side of the transducer, press **Biopsy Steering** until **Right** is selected.

If the needle is introduced from the left side of the transducer, press **Biopsy Steering** until **Left** is selected.

Panoramic

Panoramic imaging registers individual frames as the transducer is moved along a structure of interest and superimposes the registered frames to generate a composite image, allowing the visualization and measurement of large structures of interest that would not fit within the transducer's field of view.



TIP

Use adequate quantities of gel along the entire segment to be scanned to ensure smooth motion during the panoramic acquisition.

Entering panoramic imaging

Panoramic imaging is available for the L18-5, LH20-6 and L10-2 probes.

Press **Panoramic** on the touch screen.

The system enters the Panoramic Stand-by stage.

Acquiring panoramic images

1. Adjust the available imaging parameters to optimize image quality and frame rate.
2. click on the **SonicPad®** to start the acquisition.
3. Move the probe in a smooth and continuous manner along the structure of interest, making sure that the scanning motion is as much as possible parallel to the scan plane.

The system automatically detects the probe's motion direction and the composite image is being created accordingly.

4. If needed, scan backwards to erase unwanted parts of the panoramic composite image, then resume scanning along the original motion direction.
5. Press **Freeze**.

The system displays the whole composite image.



SCANNING RECOMMENDATIONS

- Ensure that the scanned surface is flat or gently curved, and avoid tissue areas dominated by noise or lacking structural details
- Use plenty of gel and apply sufficient (but not excessive) transducer pressure, to ensure good contact with the skin throughout the Panoramic acquisition.
- Use a slow and steady scanning motion without wobbling, twisting or abrupt changes in the scanning direction, staying within the same scan plane as much as possible.



WARNING

- Panoramic registration errors are manifested by the presence of artifacts such as image gaps, irregular skin line contours and jagged edges, clearly visible “seams” between successive input image frames, and blurred or poorly defined areas. If such artifacts are encountered, it

is strongly recommended to discard the current Panoramic composite image and repeat the Panoramic acquisition.



NOTE

- All measurements derived from a Panoramic composite image are marked by an asterisk, to indicate that they represent estimated measurement results and may have been affected by Panoramic registration errors.
- When the structure to be measured can fit within the transducer's field of view, it is strongly recommended to use a standard B-mode image frame and not the Panoramic composite image.

Manipulating panoramic images

DISPLAY

Use the **Zoom** functionality as for regular B-mode.

Use the **Pan** functionality as for regular B-mode.

Use the **Rotate** button or the **SonicPad®** to rotate the panoramic composite image.

Use the **Smoothing** knob to soften abrupt transitions between input frames in the Panoramic composite image.

TRIM

Trim allows you to discard frames from the start or end of the panoramic acquisition, so that they don't contribute to the panoramic composite image.

1. Press **Trim** on the touch screen to start trimming

The SonicPad® is arbitrated to **Trim Start**.

2. Move the **SonicPad®** towards the end of the panoramic acquisition to discard the required frames from the start of the acquisition.
3. click on the **SonicPad®** to arbitrate to Trim End.
4. Move the SonicPad® towards the start of the panoramic acquisition to discard the required frames from the end of the acquisition.
5. Turn **Trim** off to cut the trimmed frames out.

The remaining panoramic composite image will be automatically zoomed to fit on the screen.

Press **Trim Reset** to return the Trim Start and Trim End frames to the start and end of the panoramic acquisition, respectively.

SKINLINE TICK-MARKS

Skinline Tick-Marks allows you to display or hide the tickmarks along the skinline.

Press **Skinline Tick-Marks** to activate/deactivate the skinline tickmarks.

SMOOTHING

Smoothing is a spatial filter used to smooth the panoramic image in order to provide a more homogeneous appearance.

Rotate the knob located under **Smoothing**:

1. clockwise to increase smoothing
2. counterclockwise to decrease smoothing

Performing measurements on panoramic images

Press **Meas.** on the control panel to access measurements available in panoramic imaging.



WARNING

- Do not perform measurements on Panoramic composite images acquired with substantial out-of-plane motion components (such as when following a tortuous structure).
- Do not perform measurements across structures which appear as strongly hypoechoic or very noisy in the Panoramic composite image.
- Do not perform measurements on Panoramic composite images of highly-curved objects such as transverse sections through the arm or leg.

Basic measurements (distance, ellipse, trace, ...) on a Panoramic composite image are performed as in standard B-mode. Please refer to [the section called “Basic measurements” \[280\]](#) for a description of such measurements.

CURVED DISTANCE MEASUREMENTS

You can measure the distance of a curve on a panoramic image. The Curved Distance measurement tool is similar to the Trace measurement tool, but the curved distance trace is not closed. The Curved Distance measurement tool provides a distance measurement result.

To perform a Curved distance measurement:

1. Acquire the panoramic image
2. Press **Meas.** on the Control Panel
3. Press **Curved Distance** on the touch screen
A first caliper is displayed.
4. Move the first caliper at the desired location
5. click on the **SonicPad®** to anchor the first caliper
6. Move the **SonicPad®** to start tracing the curve
7. Use the Trace knob to erase the trace if needed
8. click on the **SonicPad®** to complete the measurement

The system displays the curved distance measurement result in the measurement result area.

Saving panoramic images

Press **Save Image** to store the current Panoramic composite image so that it can be reviewed, manipulated, trimmed and measured at a later time.

Exiting panoramic imaging

Press the **Panoramic** button on the touch screen to turn it off and exit panoramic imaging.

B-Mode Scanning Tips



B-MODE SCANNING

B-Mode Scanning Use appropriate Preset for each organ being scanned

Set depth to achieve desired field of view

Place focal zone at the depth of the area of interest or slightly below

Press Auto to obtain a homogeneous image

Adjust overall gain to obtain the appropriate brightness

Adjust TissueTuner™ to achieve the best resolution

Increase focal zone region for a larger focal area and increased resolution

Use Harmonic Imaging to clear fluid-filled structures

Use Resolution setting of Optimization control for increased resolution

ShearWave™ Elastography

The ShearWave™ Elastography (SWE™) mode displays information about tissue elasticity in the form of an easy to interpret color-coded image.

The elasticity information is also quantitative. Local estimation of the tissue stiffness is displayed per pixel, and can be expressed in kPa or in m/s over a wide range of values.

Accessing ShearWave™ Elastography

Press **SWE™** on the control panel from any other mode.

About the SWE™ Main Display

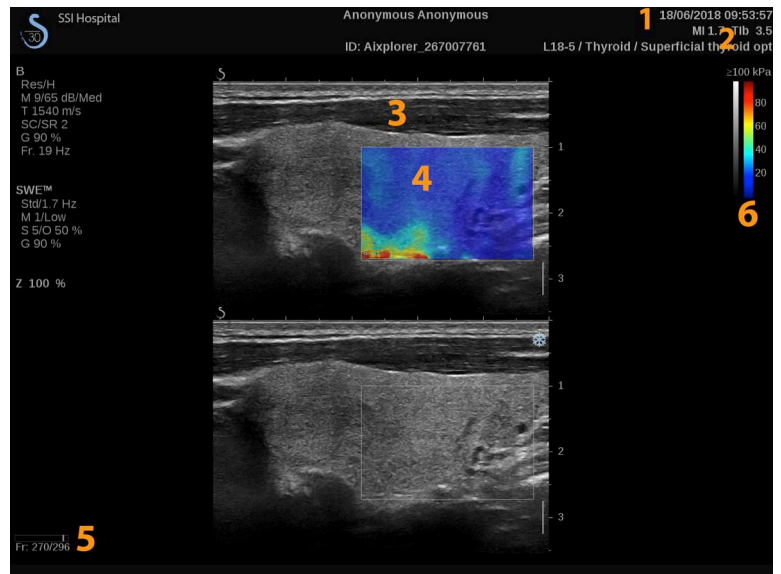

About SWE™ touch screen

When in SWE™, the touch screen displays various image settings which help you to optimize your elasticity image.

These settings are controlled by touching the control on the touch screen or turning the rotary knob directly below it.

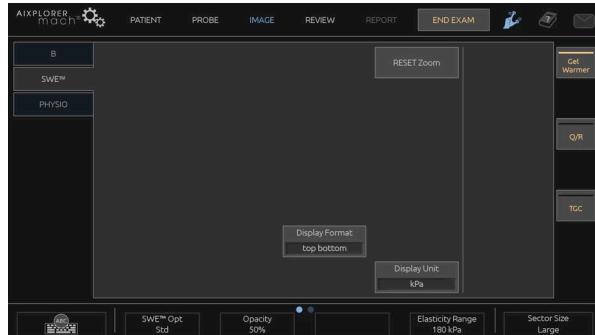

Additional rotary controls are available at the bottom of the touch screen by swiping with one finger.

Description of SWE™ Parameters

SWE™ Optimization

SWE Opt allows you to optimize the elastography resolution and penetration according to the area you are scanning.

SWE Opt is available in live imaging only.

Rotate the knob located under **SWE Opt**:

- clockwise to go to next value
- counterclockwise to go to previous value

There are 3 settings to choose from:

- **Resolution**

Use this setting when imaging small shallow areas of interest.

This setting will also help to clear any erroneous elastography signal out of areas which are suspected to be comprised of fluid.

- **Standard**

This setting is balanced between resolution and penetration.

Use this setting as the default starting point for evaluation the stiffness of a object of interest

- **Penetration**

Use this setting when imaging deeper or larger areas (anechoic or hypoechoic) which may show posterior dropout in the echo image.

These areas are suspected to be stiff and require a penetration mode optimized for high velocity shear waves.

Display unit

This control allows you to change the color bar scale for SWE™ from kPa to m/s.

Display Unit is available in live mode and on a frozen image.

Touch **Display Unit** to change its value.

Elasticity Range

The **Elasticity Range** in SWE™ mode is similar to the dynamic range in B-mode. It changes the maximum elastic value displayed.

It is used to compress the colored image for better visualization of tissues which have a variety of stiffnesses.

It does not affect the actual values of elasticity, as long as they are within the elasticity range.

Elasticity Range is available in live imaging or on a frozen image.

Rotate the knob located under **Elasticity Range**:

- clockwise to increase the elasticity range
- counterclockwise to decrease the elasticity range

Elasticity Range is displayed in kPa, the values depend on the selected application.

Stiff tissue should appear yellow, orange or red.

Increase the **Elasticity Range** if you see predominantly dark red in the color box.

Velocity Range

The **Velocity Range** works in the same manner as the Elasticity Range.

Velocity Range appears and replaces **Elasticity Range** when the **Display Unit** is set to **m/s**.

It changes the maximum velocity value displayed.

It is used to compress the colored image for better visualization of tissues which have a variety of stiffnesses.

It does not affect the actual values of velocity, as long as they are within the velocity range.

Display Format

This control changes the format in which B-mode and SWE™ images are presented on the main display.

Display Format is available in live imaging and on a frozen image.

Press **Display Format** until you select the desired format. The top/bottom format is the default setting.

Three formats are available:

- top/bottom
- side by side
- single

Opacity

Opacity allows you to change the transparency of the elasticity map over the B-mode image.

Opacity is available in live imaging and on a frozen image.

Rotate the knob located under **Opacity**:

- clockwise to increase the prominence of the color image over the B-mode image
- counterclockwise to decrease the prominence of the color image over the B-mode image

Opacity ranges from 0 to 100%.

The default setting is 50%.

Elasticity Map

Elasticity Map determines how elasticity values are displayed in terms of color graduations.

Elasticity Map is available in live imaging and on a frozen image.

Rotate the knob located under **Elasticity Map**:

- clockwise to go to the next map
- counterclockwise to go to the previous map

Acoustic Power

Acoustic Power indicates the output acoustic power.

Acoustic Power is available only in live mode.

Rotate the knob located under **Acoustic Power**:

- clockwise to increase acoustic power
- counterclockwise to decrease acoustic power

Acoustic Power values vary from 0dB to -30dB.

Smoothing

Smoothing is a spatial filter used to smooth the elasticity map in order to provide a more homogeneous appearance.

Smoothing is available only in live imaging.

Rotate the knob located under **Smoothing**:

- clockwise to increase smoothing
- counterclockwise to decrease smoothing

Persistence

This frame averaging technique reduces noise on the image.

Persistence is available in only in live imaging.

Rotate the rotary knob located under **Persistence**:

- clockwise to increase persistence
- counterclockwise to decrease persistence

TriVu

TriVu allows you to display simultaneously stiffness information with SWE mode and flow information with COL+. TriVu is available on linear probes on Breast and Thyroid applications.

Press **TriVu** to activate the TriVu display.



CAUTION

Avoid using the same color maps for SWE and CPI

Q-Box™

Refer to [the section called “Q-Box™” \[297\]](#).

Q-Box™ Ratio

Refer to [the section called “Q-Box™ ratio” \[298\]](#).

SWE™ Scanning TIPS



SWE™ SCANNING

Remember the 3 S's:

Scan **Softly**, **Smoothly** and **Slowly**

Scan **Softly**: no manual compression is needed (with the exception of intercostal liver scanning), just a light touch and plenty of gel between skin and transducer

Scan **Smoothly**: transducer automatically induces vibrations in tissues so no need to shake or push on the transducer

Scan **Slowly**: Adapt your speed of scanning to the frame rate. Once you are imaging the area of interest, avoid any movements and wait for image stabilization

Always start with the default setting of Standard for SWE Opt, and then go to Resolution or Penetration to fine tune the image.

Controls that can be used in live or frozen mode such as Elasticity Range, display format, etc. should be done after freezing to make it easier for user since it is imperative to hold a steady hand during elastography

Color Mode Imaging

Color imaging modes use Doppler principles to generate a color image of the mean flow velocity or flow power.

On the Aixplorer® Mach 30 ultrasound system, three color modes are available: Color Flow Imaging (CFI), Color Power Imaging (CPI), and Directional Color Power Imaging (dCPI).

The Various Color Modes

Color imaging modes use Doppler principles to generate a color image of the mean flow velocity or flow power.

On the Aixplorer® Mach 30 ultrasound system, three color modes are available: Color Flow Imaging (CFI), Color Power Imaging (CPI), and Directional Color Power Imaging (dCPI).

Color Flow imaging (CFI)

Color Flow Imaging is a Doppler mode intended to add color-coded quantitative information concerning the relative velocity and direction of fluid motion within the B-mode image.

Color Power Imaging (CPI)

Color Power Imaging is a color flow mapping technique used to map the strength of the Doppler signal coming from the flow rather than the frequency shift of the signal. Using this technique, the ultrasound system displays the magnitude of the flow based on the number of reflectors that are moving, regardless of their velocity. CPI does not map flow velocity.

Directional Color Power Imaging (dCPI)

Directional Color Power Imaging (dCPI) is a new flow imaging mode, which complements the two existing flow imaging modes, namely Color

Flow Imaging (CFI) and Color Power Imaging (CPI). dCPI displays the mean Doppler frequency of each pixel inside the Color box, including the direction of flow relative to the transducer.

The color maps used in dCPI are separated into parts which typically contain red and blue hues, respectively, with positive Doppler frequencies (flow towards the transducer) displayed using the top part of the dCPI color map, and negative Doppler frequencies (flow away from the transducer) displayed using the bottom part of the dCPI color map. dCPI is useful in indicating the flow direction within the vessels of interest, as well as identifying areas of high flow velocities (aliasing), flow reversals, etc.

Accessing Color Modes

Press **COL** on the control panel from any other modes.

About Color Modes Main Display

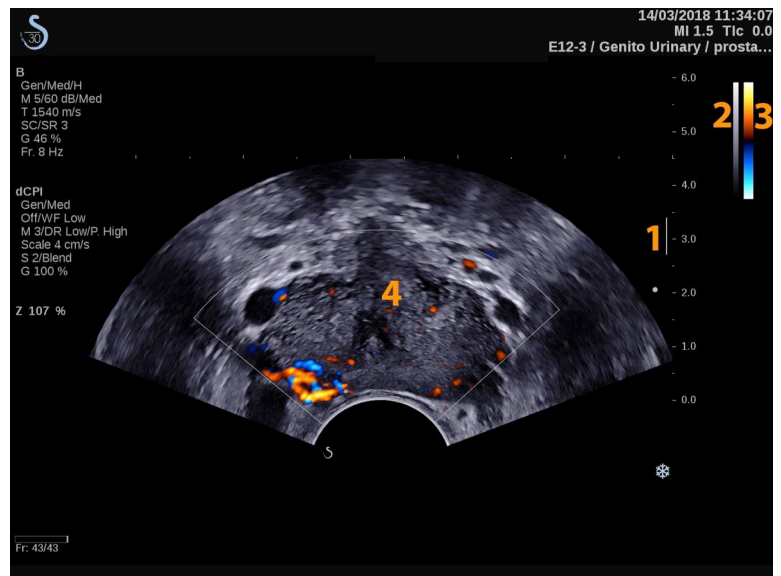

1. Focal Zone
3. Color bar

2. Grayscale
4. Color box

About Color Modes Touch Screen

When in color modes, the touch screen displays various image settings which help you to optimize the color image.

These settings are controlled by touching the control on the touch screen or turning the rotary knob directly below it.

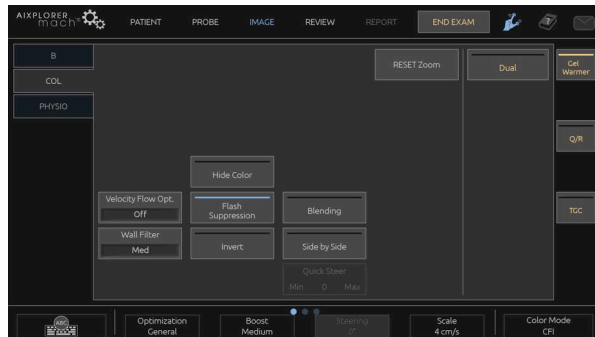

Additional rotary controls are available at the bottom of the touch screen by swiping with one finger.

Description of Color Imaging Parameters

Color Mode

Color Mode allows you to switch between CFI, dCPI and CPI.

Color Mode is available only in live imaging.

Touch **Color Mode** to select the desired mode.

Dual

See [the section called “Dual” \[186\]](#).

Optimization

Optimization allows you to change center frequency to obtain increased resolution or increased penetration. **Optimization** is available only in live imaging. Rotate the knob located under **Optimization** to change value:

- Resolution
- General
- Penetration

Boost

Boost allows you to adjust frame rate and line density to achieve increased spatial or temporal resolution.

There are three options to choose from:

- High Definition
- Medium
- High Frame Rate

Rotate the knob located under **Boost** to change its value.

Invert

Invert lets you view blood flow from an inverse perspective, e.g. red away (negative velocities) and blue toward (positive velocities) the transducer.

Invert is available in live imaging and on a frozen image.

Invert is available only in CFI mode.

Touch **Invert** to activate and deactivate it.

Scale

Scale allows you to adjust the maximum displayed velocity.

Scale is available only in live imaging.

Rotate the knob located under **Scale**:

- clockwise to increase the scale
- counterclockwise to decrease the scale

Hide Color

Hide Color hides the color information over the B-mode image.

Hide Color is available in live imaging and on a frozen image.

Touch **Hide Color** to activate and deactivate it.

Wall Filter

This parameter filters out low velocity signals.

It helps to decrease motion artifacts caused by patient or transducer motion.

Wall Filter is available only in live imaging.

Touch **Wall Filter** until you select the desired value.

Velocity Optimization

Velocity Opt. allows you to quickly optimize multiple parameters with one control to achieve a desired flow optimization.

Velocity Opt. changes the following parameters:

- scale
- wall filter
- resolution/frame rate
- persistence

Velocity Opt. is available only in live imaging.

Touch **Velocity Opt.** until you select the desired value.

Side by Side

Side by Side allows you to split the screen in two live parts:

- the left side displays the B-mode only, for reference
- the right side displays the B-mode and the color image

Baseline

Baseline is a horizontal graphical line on the Color Map that represents the level of zero velocity.

The baseline position contributes in defining the maximum positive and negative velocities.

By changing the baseline position, you increase the maximum positive velocity and decrease the maximum negative velocity, or vice versa.

Baseline is available only in live imaging and on a frozen image.

Rotate the knob located under **Baseline**:

- clockwise to increase the maximum positive velocities
- counterclockwise to increase the maximum negative velocities

Note: The **Baseline** control is available only in CFI mode. In CPI, it is replaced by **Dynamic Range**.

Dynamic Range allows you to change the range over which the amplitude of returning ultrasound signals are displayed. It behaves in the same manner as **Baseline**.

Quick Steer

Quick Steer allows you to quickly steer the insonifying beam.

Press **Quick Steer** to change its value.

Use the **Steering** knob for finer settings.

Steering

To maximize the sensitivity and accuracy of color Doppler modes, it is usually recommended that clinical Doppler examinations be conducted with a Doppler angle equal to or less than 60 degrees between the ultrasound beam and the vessel direction.

Steering is available only in live imaging.

Rotate the knob located under **Steering** to steer the color box.

Acoustic Power

Acoustic Power indicates the output acoustic power.

Acoustic Power is available only in live mode.

Rotate the knob located under **Acoustic Power**:

- clockwise to increase acoustic power
- counterclockwise to decrease acoustic power

Acoustic Power values vary from 0dB (maximum power) to -20dB (minimum power).

Smoothing

Smoothing is a spatial filter used to smooth the color image in order to provide a more homogeneous appearance.

Smoothing is available only in live imaging.

Rotate the knob located under **Smoothing**:

- clockwise to increase smoothing
- counterclockwise to decrease smoothing

Persistence

This frame averaging technique reduces noise on the image.

Persistence is available in live imaging and on a frozen image (to view clips).

Rotate the rotary knob located under **Persistence**:

- clockwise to increase persistence
- counterclockwise to decrease persistence

Color Priority

Color Priority allows you to select a level beyond which color data are not displayed over the gray map.

Color Priority is available in live imaging and on a frozen image.

Rotate the knob located under **Color Priority**:

- clockwise to increase the color priority
- counterclockwise to decrease color priority

The range and default value depend on the application.

Color Map

Color Map determines how flow values are displayed in terms of color graduations.

Color Map is available in live imaging and on a frozen image.

Rotate the knob located under **Color Map**:

- clockwise to go to next map
- counterclockwise to go to previous map

Blending

This button controls the level of transparency of the color image that is superimposed on the B-mode image.

When **Blending** is on, the color image is smoothly overlaid on the grayscale image.

When **Blending** is Off, the transition between B-mode and color is sharper.

Blending is available in live imaging and on a frozen image.

Press **Blending** to turn it On or Off.

Flash Suppression

Flash Suppression utilizes an adaptive wall filtering scheme in order to suppress the flash artifacts due to tissue motion.

When **Flash Suppression** is On, the frame rate is reduced.

Flash Suppression is available only in live imaging.

Press **Flash Suppression** to turn it On or Off.

UltraFast™ Doppler Duration

UltraFast™ Doppler Duration allows you to select the duration of the **UltraFast™ Doppler Acquisition**.

Touch **UltraFast™ Doppler Duration** until you select the desired value.

UltraFast™ Doppler Acquisition

UltraFast™ Doppler Acquisition launches a prospective capture of CFI, CPI or dCPI at high frame rates.

UltraFast™ Doppler Acquisition is available with the L10-2, and C6-1X probes.

Once you have chosen the imaging plane, press **UltraFast™ Doppler Acquisition** to start the acquisition.

Do not move the probe as long as the message “acquiring...” is displayed on the screen.

When the acquisition is complete, you have access to the following controls:

COLOR GAIN

Rotate the **COL** button in order to change the gain in review:

- clockwise to increase the gain
- counterclockwise to decrease the gain

DISPLAY FORMAT

Display Format allows you to change the view mode as follows:

- **Full screen** displays the image only
- **Quad** divides the screen into 4 parts: Clip, Mean Velocities, Peak Systolic frame and Max Velocities
- **Spectrogram** displays the image on the top and the spectrograms underneath.

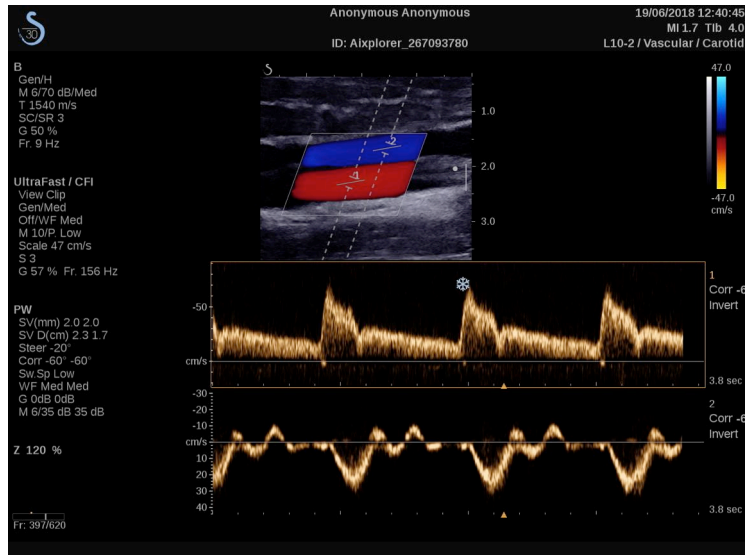

Press **Display Format** until you select the desired format.

The button next to **Display Format** allows you to control the image:

Clip allows you to scroll the UltraFast™ Doppler clip

- **PS** displays the image of the UltraFast™ Doppler clip that contains the peak systolic frame
- **Max** displays a calculated image corresponding to the maximum velocity of each pixel within the UltraFast™ Doppler clip
- **Mean** displays a calculated image corresponding to the mean velocity of each pixel within the UltraFast™ Doppler clip Press the desired part of the button to change the view mode.

DISPLAY PEAK SYSTOLIC FRAME

This control automatically locates and displays the peak frame in the UltraFast™ Doppler CFI clip buffer.

COLOR MAP

See [the section called “Color Map” \[218\]](#).

BLENDING

See [the section called “Blending” \[219\]](#) .

HIDE COLOR

See [the section called “Hide Color” \[215\]](#).

PERSISTENCE

See [the section called “Persistence” \[218\]](#).

COLOR PRIORITY

See [the section called “Color Priority” \[218\]](#).

ADD SPECTROGRAM

In UltraFast™ Doppler mode, you have the capability to add up to 3 sample volumes on the reviewed image to compute simultaneous spectrograms.

1. Press **Add Spectrogram** to add a spectrogram
2. Use the **SonicPad®** to resize the sample volume
3. Use the **SonicPad®** to locate the sample volume on the image and update the spectrogram

The active spectrogram appears surrounded with an orange rectangle.

Click on the **SonicPad®** to change the active spectrogram.

You may add measurements on the active spectrogram. See [???](#).

Once a spectrogram has been added, you have access to a variety of PW parameters and tools.

DELETE SPECTROGRAM

This control deletes the active spectrogram and corresponding sample volume from the image.

WALL FILTER

See [the section called “Wall Filter” \[215\]](#).

SWEEP SPEED

See [the section called “Sweep Speed” \[232\]](#).

DYNAMIC RANGE

See [the section called “Dynamic Range” \[230\]](#).

SCALE

See [the section called “Scale” \[232\]](#).

SMOOTHING

See [the section called “Smoothing ” \[217\]](#)

COARSE ANGLE

See [the section called “PW Coarse Angle” \[229\]](#).

FINE ANGLE CORRECT

See [the section called “Fine Angle Correct” \[230\]](#).

PW MAP

See [the section called “PW Map” \[231\]](#).

INVERT

See [the section called “Invert” \[231\]](#).

PW GAIN

Rotate the **PW** button in order to change the gain in review:

- clockwise to increase the gain
- counterclockwise to decrease the gain

DELETE SPECTROGRAM

This control deletes the active spectrogram and corresponding sample volume from the image.

Angio PL.U.S.

Angio PL.U.S. is a Color mode optimization for a better visualization of slow flows. It may be used in Breast, MSK, Abdominal, and Thyroid applications on L10-2, L18-5, C6-1X probes.

Please note that Angio PL.U.S. is a Color Doppler technique and, therefore, provides only qualitative maps of Doppler velocity.

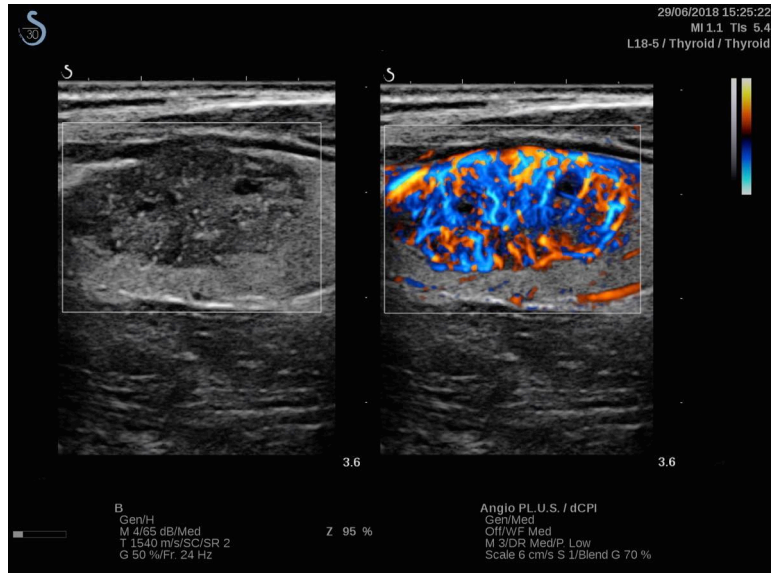

1. Press Probe
2. Select the appropriate application and preset
3. Optimize the B-mode image
4. Press Color
5. Press Angio PL.U.S. RT on the touch screen
6. The Angio PL.U.S. is in live mode
7. Select the plane of interest
8. Press Angio PL.U.S. HD Acquisition for enhanced performances
9. A prospective clip is being acquired
10. The system freezes
11. Review the clip

COLOR Scanning TIPS



COLOR SCANNING

Scan to obtain best angle to maximize flow sensitivity.

Use the SonicPad® to change size of color box if needed. A larger box will cause a decrease in temporal resolution (frame rate).

Increase Color Gain until you see noise and then reduce the gain just to eliminate noise. This will ensure that you have the best color flow sensitivity possible.

If scanning smaller vessels (i.e. breast, thyroid), center steer is typically the best choice. In larger vessels (i.e. carotid artery, axillary artery) steer color box to obtain the best (least) angle to flow. You will see a change in sensitivity when you choose the appropriate steering angle.

Select the appropriate Velocity Optimization level according to the type of vessel you are interrogating.

Low is typically used for smaller vessels with lower velocities and venous flows.

High is used for larger vessels with higher velocities and for arteries.

To increase flow sensitivity, you can lower the Scale or lower the Wall Filter. To eliminate aliasing (CFI only), increase the Scale.

Do not move the probe while acquiring an UltraFast™ Doppler CFI clip

Pulsed Wave Doppler Mode

Pulsed Wave Doppler (PW) is a Doppler mode that measures velocity of blood flow within a small region called the Doppler sample volume.

This information is presented as a sweeping display of velocity (or Doppler frequency) over time. This display is often called a spectral Doppler trace, or Doppler trace. The information may also be heard as a stereo audio output.

In addition to the Doppler velocity display, an image (grayscale only or grayscale and color) is also presented to guide you for proper positioning of the Doppler sample volume.

Accessing PW

Press **PW** on the control panel from any other modes.

About PW Main Display

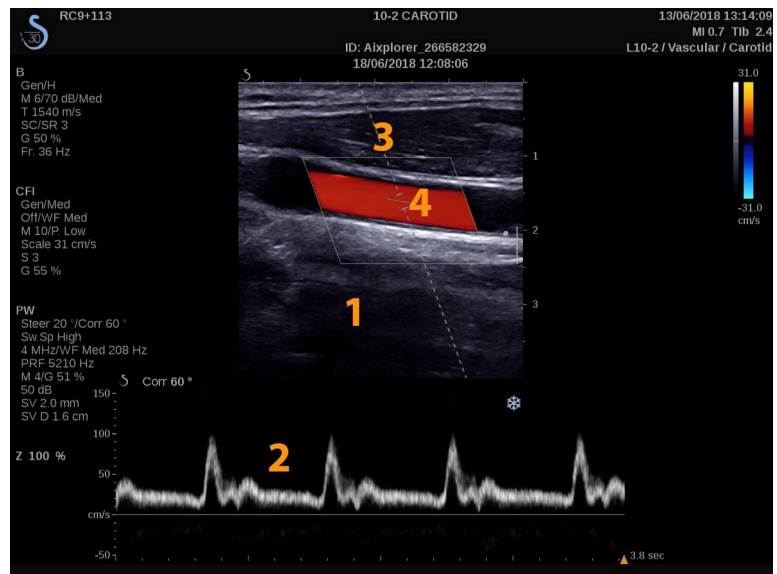

1. Grayscale image

2. Spectral display

About PW Touch Screen

When in PW, the touch screen displays various image settings which help you to optimize your PW image and trace.

These settings are controlled by touching the control on the touch screen or turning the rotary knob directly below it.

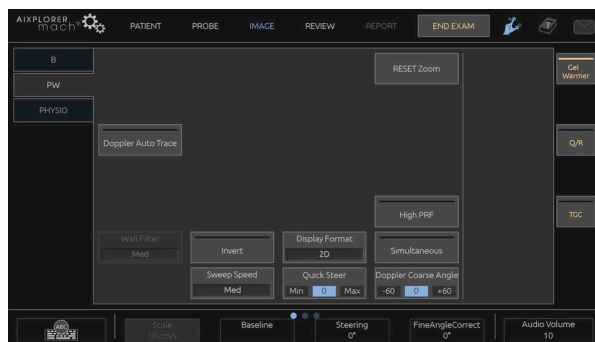

Additional rotary controls are available at the bottom of the touch screen by swiping with one finger.

Setting Up PW

Doppler Line

Swipe left and right on the **SonicPad®** to move the Doppler line in the 2D image.

Sample Volume Position

Swipe up and down on the **SonicPad®** to move the sample volume on the Doppler line.

Sample Volume Size

Slide your finger on the **SonicPad®** to change the size of the sample volume.

Description of PW Imaging Parameters

Quick Steer

Quick Steer allows you to quickly steer the insonifying beam.

Press **Quick Steer** to change its value.

Use the **Steering** knob for finer settings.

Steering

The insonifying beam can be steered in a direction as close as possible to the expected direction of motion, within limitations imposed by the transducer and the image plane geometry.

Steering is available only in live imaging.

Rotate the knob located under **Steering** to steer the Doppler line.

PW Coarse Angle

PW Coarse Angle is available in live imaging and on a frozen image.

Touch **PW Coarse Angle** until you select the desired value.

Fine Angle Correct

Fine Angle Correct is available in live imaging and on a frozen image.

Rotate the knob located under **Fine Angle Correct**.

Acoustic Power

Acoustic Power indicates the output acoustic power.

Acoustic Power is available only in live mode.

Rotate the knob located under **Acoustic Power**:

- clockwise to increase acoustic power
- counterclockwise to decrease acoustic power

Acoustic Power values vary from 0dB (maximum power) to -20dB (minimum power).

Dynamic Range

You can optimize the PW dynamic range independently from the B-mode dynamic range.

Rotate the rotary knob located under **Dynamic Range**:

- clockwise to increase the dynamic range
- counterclockwise to decrease the dynamic range

Display Format

Display Format is available in live imaging and on a frozen image.

Press **Display Format** to change its value.

5 display formats are available:

- 2D only
- 1/3 B-mode and 2/3 spectral display
- B-mode and spectral side by side display
- ½ B-mode and ½ spectral display
- 2/3 B-mode and 1/3 spectral display

PW Map

PW Map is available in live imaging and on a frozen image.

Rotate the knob located under **PW Map**:

- clockwise to go to previous map
- counterclockwise to go to next map

Invert

Invert vertically flips the spectral display without affecting the baseline position.

Typically, positive velocities (velocities toward the transducer) are shown above the baseline while negative velocities (velocities away from the transducer) are shown below the baseline.

Invert flips the location of positive and negative velocities relative to the baseline.

Invert is available in live imaging and on a frozen image.

Touch **Invert** to activate and deactivate it.

Wall Filter

This parameter filters out low velocity signals.

It helps to decrease motion artifacts caused by patient or transducer motion.

Wall Filter is available only in live imaging.

Touch **Wall Filter** until you select the desired value.

Scale

Scale allows you to modify the maximum velocities displayed on the Doppler spectrum.

Scale is available only in live imaging.

Rotate the knob located under **Scale**:

- clockwise to increase the scale
- counterclockwise to decrease the scale

Baseline

Baseline is a horizontal graphical line that represents the level of zero velocity.

The baseline position contributes in defining the maximum positive and negative velocities.

By changing the baseline position, you increase the maximum positive velocity and decrease the maximum negative velocity, or vice versa.

Baseline is available only in live imaging and on a frozen image.

Rotate the knob located under **Baseline**:

- clockwise to move the Baseline up
- counterclockwise to move the Baseline down

Sweep Speed

Sweep Speed allows you to change the speed with which the spectral columns are updated on the display.

Sweep Speed is available in live imaging and on a frozen image.

Touch **Sweep Speed** until you reach the desired value.

Simultaneous Duplex and Triple Modes

Simultaneous allows real-time evaluation of vascularity when respiration or motion make stand alone PW evaluation more difficult.

Simultaneous is available only in live imaging.

Touch **Simultaneous** to turn it On or Off.

In B-mode, **Simultaneous** displays and updates the PW spectral trace and the B-mode image.

In Color, **Simultaneous** displays and updates the PW spectral trace and the Color image.

High PRF

High PRF allows you to measure flows of higher velocities than those that can be measured with the maximum conventional available PRF, by increasing the PRF above the Nyquist limit and avoiding aliasing.

HOW IT WORKS:

High PRF extends the PW Doppler velocity scale beyond the maximum velocity limit that can be measured for a given sample volume in a nonambiguous manner. Beyond this limit, the Pulse Repetition Frequency (PRF) of the transmitted PW Doppler pulses corresponds to a Pulse Repetition Interval (PRI) which is shorter than the roundtrip propagation time from the transducer to the current sample volume depth, resulting in range ambiguity (the analyzed Doppler signals emanate not only from the primary sample volume of interest but also from one or two secondary sample volumes along the Doppler beam).

HOW TO USE IT:

Touch **High PRF** to turn it on.

The maximum scale available is increased as a function of depth.

High PRF is available for all presets on all probes in live PW.



SCANNING RECOMMENDATIONS

- Position the primary SV in the area of interest, as you would in conventional PW Doppler.
- Avoid, as much as possible, placing secondary SV's in areas dominated by noise artifacts, shadowing, or areas of flow.
- These tips may assist you in positioning secondary High PRF SV's to optimize the signal and avoid interference with the primary SV:
 - Vary the velocity range to change the secondary sample volume position.
 - Vary the depth of the image to change the secondary sample volume position.
 - Reduce the velocity range to remove the secondary sample volume.
 - Reduce gain.
 - Vary 2D image orientation.
 - Change the acoustic window.

PW TDI (Tissue Doppler Imaging)

TDI allows you to assess tissue motion velocities using dedicated PW mode optimizations and parameters.

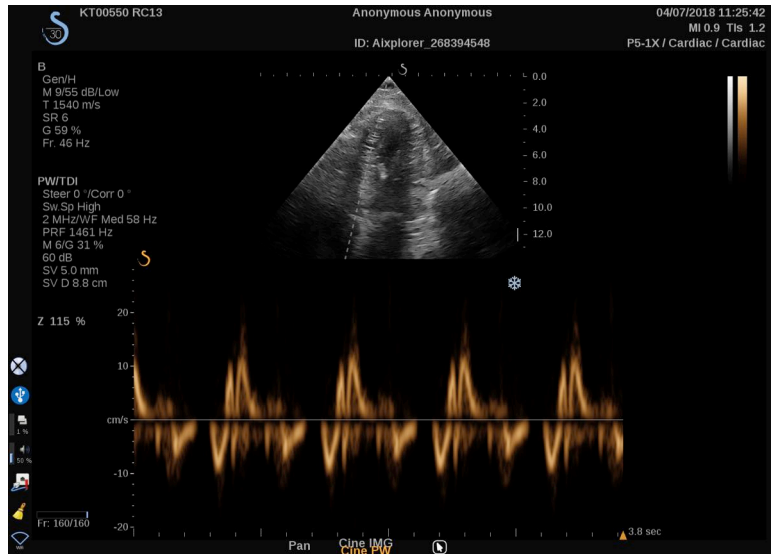

PW Autotrace

This control allows you to perform automatic PW measurements.

You may customize which measurements are displayed when performing a PW Autotrace in the System Configuration.

PW Autotrace is available in live imaging and on a frozen image.

Press **PW Autotrace** to display the envelope of the peak velocity of the flow as a function of time.

When the **PW Autotrace** is activated, you have access to the following settings:

MEAN TRACE

Press **Mean Trace** to display the mean flow velocity as a function of time.

VELOCITY POINTS

Press **Velocity Points** to display the PSV and EDV on the spectrum.

TRACE DETECTION

Trace Detection allows you to detect the following velocity traces:

- the velocities above the baseline
- the velocities below the baseline
- the velocities both above and below the baseline

Press **Trace Detection** to change its value.

SENSITIVITY

This control defines the detection threshold for the PW Autotrace.

Press **Sensitivity** to change its value.

SELECT CYCLES

This control allows you to change the cardiac cycles on which the values calculated when the PW Autotrace is launched are averaged.

Rotate the knob located under **Select Cycles**:

- clockwise to select next cycle(s)
- counterclockwise to select previous cycle(s)

NB CYCLES

By default, the calculated values when the PW Autotrace is launched are averaged on 3 cardiac cycles from the end of the PW spectrum.

Press **Nb Cycles** to change its value.

AUTOTRACE TRIM

This control allows you to manually change the goalposts for the AutoTrace calculation.

1. Press **AutoTrace Trim** to edit the goalposts
2. Use the **SonicPad®** to place the left goalpost
3. click on the **SonicPad®** to anchor it
4. Use the **SonicPad®** to place the right goalpost
5. click on the **SonicPad®** to anchor it

PW Scanning Tips



PW SCANNING

As in color Doppler, optimize the scan plane for the best angle to flow.

Activate the PW cursor by pressing PW. Optimize the steering angle and sample volume size before initiating the PW spectral trace. If Color is activated before pressing PW, then the cursor will be at the same steer angle as the color box.

Optimize Doppler gain. Decrease gain to eliminate background noise.

Increase scale or shift baseline to eliminate aliasing.

You can always shift baseline, change display format, PW map and sweep speed after freezing.

Use Simultaneous mode when vessels are difficult to follow due to respiration, motion or small vessel size.

Continuous Wave Doppler

Continuous Wave Doppler (CW) is a Doppler mode that allows measuring very high velocities of blood flow along an entire line of interrogation. In this mode, the probe continuously sends out pulses of ultrasound along a line and continuously listens for many reflected frequency shifts that are coming back.

This information is presented as a sweeping display of velocity (or Doppler frequency) over time. This display is often called a spectral Doppler trace, or Doppler trace. The information is also heard as a stereo audio output.

In addition to the Doppler velocity display, an image (grayscale only or grayscale and color) is also presented to guide you for proper positioning of the CW Doppler line.

Accessing CW

Press CW on the control panel from any other modes, in cardiac preset.

About CW Main Display

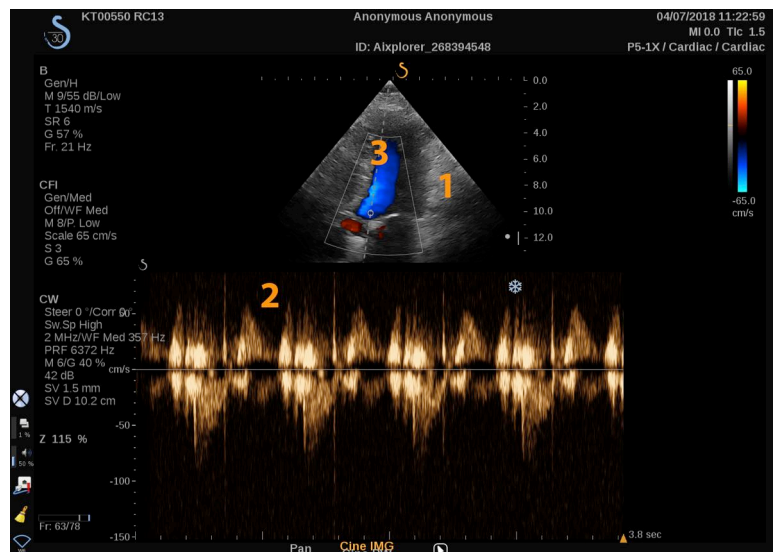

1. Grayscale image
3. Doppler line

2. Spectral display

About CW Touch Screen

When in CW, the touch screen displays various image settings which help you to optimize your CW image and trace.

These settings are controlled by touching the control on the touch screen or turning the rotary knob directly below it.

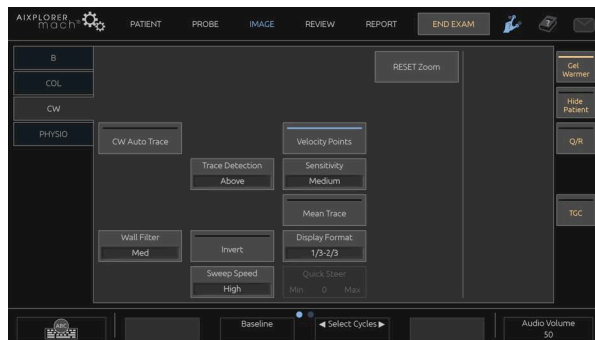

Additional rotary controls are available at the bottom of the touch screen by swiping with one finger.

Setting Up CW

CW Gain

To increase or decrease the CW gain, rotate the PW button.

Doppler Line

Swipe left and right on the SonicPad® to move the Doppler line in the 2D image.

Sample Volume Position

Swipe up and down on the SonicPad® to move the sample volume on the Doppler line.

Description of CW Imaging Parameters

CW Coarse Angle

CW Coarse Angle is available in live imaging and on a frozen image.

Touch **CW Coarse Angle** until you select the desired value.

Fine Angle Correct

Fine Angle Correct is available in live imaging and on a frozen image.

Rotate the knob located under **Fine Angle Correct**.

Acoustic Power

Acoustic Power indicates the output acoustic power.

Acoustic Power is available only in live mode.

Rotate the knob located under **Acoustic Power**:

- clockwise to increase acoustic power
- counterclockwise to decrease acoustic power

Acoustic Power values vary from 0dB (maximum power) to -20dB (minimum power).

Dynamic Range

You can optimize the CW **Dynamic Range** independently from the B-mode **Dynamic Range**.

Rotate the rotary knob located under **Dynamic Range**:

- clockwise to increase the dynamic range
- counterclockwise to decrease the dynamic range

Display Format

Display Format is available in live imaging and on a frozen image.

Press **Display Format** to change its value.

5 display formats are available:

- 2D only
- 1/3 B-mode and 2/3 spectral display
- B-mode and spectral side by side display
- 1/2 B-mode and 1/2 spectral display
- 2/3 B-mode and 1/3 spectral display

CW Map

CW Map is available in live imaging and on a frozen image.

Rotate the knob located under **CW Map**:

- clockwise to go to previous map
- counterclockwise to go to next map

Invert

Invert vertically flips the spectral display without affecting the baseline position.

Typically, positive velocities (velocities toward the transducer) are shown above the baseline while negative velocities (velocities away from the transducer) are shown below the baseline.

Invert flips the location of positive and negative velocities relative to the baseline.

Invert is available in live imaging and on a frozen image.

Touch **Invert** to activate and deactivate it.

Wall Filter

This parameter filters out low velocity signals. It helps to decrease motion artifacts caused by patient or transducer motion.

Wall Filter is available only in live imaging.

Touch **Wall Filter** until you select the desired value.

Scale

Scale allows you to modify the maximum velocities displayed on the Doppler spectrum.

Scale is available only in live imaging.

Rotate the knob located under **Scale**:

- clockwise to increase the scale
- counterclockwise to decrease the scale

Baseline

Baseline is a horizontal graphical line that represents the level of zero velocity.

The baseline position contributes in defining the maximum positive and negative velocities.

By changing the baseline position, you increase the maximum positive velocity and decrease the maximum negative velocity, or vice versa.

Baseline is available only in live imaging and on a frozen image.

Rotate the knob located under **Baseline**:

- clockwise to move the Baseline up
- counterclockwise to move the Baseline down

Sweep Speed

Sweep Speed allows you to change the speed with which the spectral columns are updated on the display.

Sweep Speed is available in live imaging and on a frozen image.

Touch **Sweep Speed** until you reach the desired value.

CW Autotrace

This control allows you to perform automatic CW measurements.

You may customize which measurements are displayed when performing a **CW Autotrace** in the System Configuration.

CW Autotrace is available in live imaging and on a frozen image. Press **CW Autotrace** to display the envelope of the peak velocity of the flow as a function of time.

When the **CW Autotrace** is activated, you have access to the following settings:

MEAN TRACE

Press **Mean Trace** to display the mean flow velocity as a function of time.

VELOCITY POINTS

Press **Velocity Points** to display the peak systolic velocity points and end diastolic velocity points on the spectrum.

TRACE DETECTION

Trace Detection allows you to detect the following velocity traces:

- the velocities above the baseline
- the velocities below the baseline
- the velocities both above and below the baseline

Press **Trace Detection** to change its value.

SENSITIVITY

This control defines the detection threshold for the CW Autotrace.

Press **Sensitivity** to change its value.

SELECT CYCLES

This control allows you to change the cardiac cycles on which the values calculated when the CW Autotrace is launched are averaged.

Rotate the knob located under **Select Cycles**:

- clockwise to select next cycle(s)
- counterclockwise to select previous cycle(s)

NB CYCLES

By default, the calculated values when the CW Autotrace is launched are averaged on 3 cardiac cycles from the end of the CW spectrum.

Press **Nb Cycles** to change its value

AUTOTRACE TRIM

This control allows you to manually change the goalposts for the AutoTrace calculation.

1. Press AutoTrace Trim to edit the goalposts
2. Use the SonicPad® to place the left goalpost
3. click on the SonicPad® to anchor it
4. Use the SonicPad® to place the right goalpost
5. click on the SonicPad® to anchor it

3D Imaging

Accessing 3D Imaging

The 3D package is available with the LV16-5 probe for the Breast and General applications

The 3D mode is available with B-mode, and SWE modes depending on the probe and application/preset combination.

Before starting a 3D acquisition:

1. Make sure the 3D probe is plugged in
2. Press **Probe** on the control panel
3. Select an **application** tab on the touch screen
4. Select the desired **Preset**
5. Scan to locate the region of interest and optimize the B-mode, Color or SWE image

Acquisition

1. Press **Volume Size** until you select the size of the volume you want to acquire:
 - M
 - L
 - XL
2. Press the **3D Acquisition** button to start the 3D acquisition

During the acquisition, a progress bar is displayed on the screen.

To cancel the 3D acquisition in progress, press **3D Acquisition** again.

Multi-Planar Reconstruction (MPR)

MPR Active view

Press **A** (Axial), **C** (Coronal), **T** (Transverse), or **3D** to select the active view.

MPR Display

When the 3D acquisition is complete, the system displays the default Multi Plane view.

Rotate the knob located under **View Mode** to change the Multi Plane view mode.

The active view will define the reference view to be displayed in the different view modes.

MPR Navigation

When the **cursor** is ON:

1. Press **Navigation** on the touch screen until Translate is selected
2. Select the navigation view using the **SonicPad®**
3. Use the **SonicPad®** to navigate in the selected view

When the **cursor** is OFF:

1. Press **Navigation** on the touch screen until Translate is selected
2. Use the **SonicPad®** to navigate in the selected view

Rotation

When the **cursor** is ON:

1. Press **Navigation** on the touch screen until Rotation is selected
2. Move the **cursor** on the view you want to rotate
3. Use the **SonicPad®** to rotate the selected view
4. click on the **SonicPad®** to center the planes that are perpendicular to the selected view

When the **cursor** is OFF:

1. Press **Navigation** on the touch screen until Rotation is selected
2. Use the **SonicPad®** to rotate the selected view

Other Controls

SLAB THICKNESS

Rotate the knob located under **Slab thickness** to change the value

SLAB RENDERING

Rotate the knob located under **Slab Render** to change the value.

- Use **Min** to reinforce hypoechoic structures
- Use **Max** to reinforce hyperechoic structures
- Use **Avg** or **Median** to enhance contrast/resolution trade-off

ZOOM

Rotate **Zoom** to zoom on the intersection of A, T and C planes.

Multi Slice (MS)

Press **Multi Slice** on the touch screen to access Multi Slice mode

Active View

Press **A**, **C** or **T** to select the active view.



NOTE

Move the cursor on a given view to highlight it in the reference view.

Display

Press **Slice Number** to change the number of slices displayed on the screen.

Navigation

Use the **SonicPad®** to translate the middle plane of the MultiSlice display.

Other Controls

SLICE DISTANCE

Rotate the knob located under **Slice distance** to change the value.

SLAB THICKNESS

Rotate the knob located under **Slab thickness** to change the value.

SLAB RENDERING

Rotate the knob located under **Slab rendering** to change the value.

3D History Loop

You can view a clip of the 2D images acquired during the 3D acquisition.

Deactivate **Multiplane** and **Multislice** on the touch screen. The system is in 3D history loop mode.

Use the **SonicPad®** to scroll the 3D history loop.

3D and SWE™

SWE 3D FILTER

3D Filter is a smoothing spatial filter that allows you to smooth the elasticity map.

Rotate the knob located under **3D Filter** to increase or decrease smoothing.

3D Measurements

In addition to the 2d measurement tools, Aixplorer® Mach 30 is providing various measurement features for the assessment of volume both in Multiplanar and MultiSlice displays:

- 3D volume calculated from an ellipse and a distance (MPR)
- 3D volume calculated from 3 distances (MPR)
- 3D volume calculated from a collection of traces distributed in a volume (MS).

BASIC MEASUREMENTS

Refer to [the section called “Basic measurements” \[280\]](#) for a step by step description of distance, ellipse, trace, Q-Box™ and Q-Box Ratio™ measurements.

LABELED MEASUREMENTS

Refer to [the section called “Labeled measurements” \[301\]](#).

3D-SPECIFIC MEASUREMENTS

Ellipse Distance Volume

The Ellipse distance 3D volume measurement tool is available in MPR display only.

1. Press **Meas. Tools** on the touch screen
2. Press **Volume (Ellipse + Distance)**
3. Use your preferred method to draw an ellipse on the plane of interest (see 2D [the section called “Basic measurements” \[280\]](#)) Once the ellipse is drawn, the system displays the first caliper of a distance measurement.
4. Choose an orthogonal plane to draw the distance

Once the distance is drawn, the system displays the values of the volume in the measurement result area.

3-Distance Volume

The 3-distance 3D volume measurement tool is available in MPR display only.

1. Press **Meas. Tools** on the touch screen
2. Press **Volume (3 Distance)**
3. Use your preferred method to draw 2 distances (see 2D [the section called “Basic measurements” \[280\]](#)) on the plane of interest

Once the first distance is drawn, the system displays the first caliper of the second distance measurement.

1. Once the second distance is drawn, choose an orthogonal plane to draw the last distance

Once the last distance is drawn, the system displays the values of the volume in the measurement result area.

Trace Collection Volume

1. Press **Meas. Tools** on the touch screen
2. Press **Volume (Trace Method)**
3. Use your preferred method to draw a first trace on a given slice (see 2D [the section called “Basic measurements” \[280\]](#))

Once the first trace is drawn, the system displays the first caliper of the next adjacent slice.

1. Draw as many trace measurements as needed (a minimum of 2 is required to calculate a volume)
2. Press **End** to finalize the measurement

The system displays the values of the volume in the measurement result area.



CAUTION

Make sure the image quality of the 3D acquisition is sufficient in order to perform a 3D volume measurement.

3D On-cart Review Package

The 3D on-cart review package allows you to append a closed exam and save a secondary capture with new information from acquired 3D volumes coming from the former exam.

Contrast Enhanced Ultrasound Imaging (CEUS)

Contrast Enhanced Ultrasound Imaging (CEUS) is a mode of imaging which allows you to assess micro and macro-vascular perfusion information in an ultrasound image.

CEUS requires that the ultrasound imaging be performed in conjunction with the injection of a microbubble based contrast agent.

The microbubbles appear as intravascular tracers in the ultrasound image, allowing the differentiation of structures based on their vascularity.



NOTE

SuperSonic Imagine does not sell contrast agent products.



CAUTION

CEUS is available only for the liver in the USA. Do not use CEUS in other organs.

Carefully follow manufacturer's instructions for use, including indications and contra indications, when administering ultrasound contrast agents.

Accessing CEUS Mode

Press CEUS on the control panel from any other mode.

This will engage the CEUS and B-mode side-by-side display.

About CEUS Mode Main Display

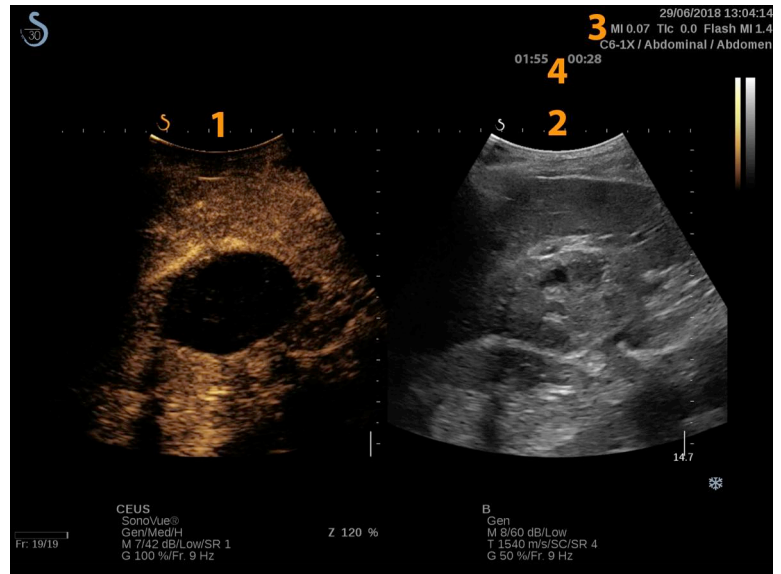

1. contrast image
2. grayscale image
3. MI and TI information
4. Timers

The CEUS display on the left is the default image, and the CEUS controls are active by default.

Some panel controls such as the Gain knob and Auto are shared between CEUS and B-mode. The currently selected mode will determine which image the control will act upon.

About CEUS mode touch screen

About CEUS mode touch screen When in CEUS mode, the touch screen displays various image controls which help you to optimize the CEUS mode image.

These settings are controlled by touching the control on the touch screen, or by turning the rotary knob directly below the touch screen.

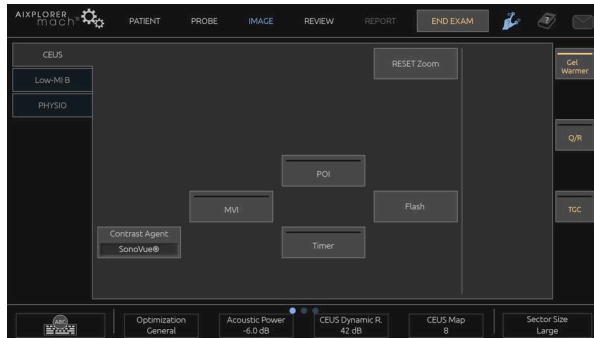

CEUS touch screen parameters

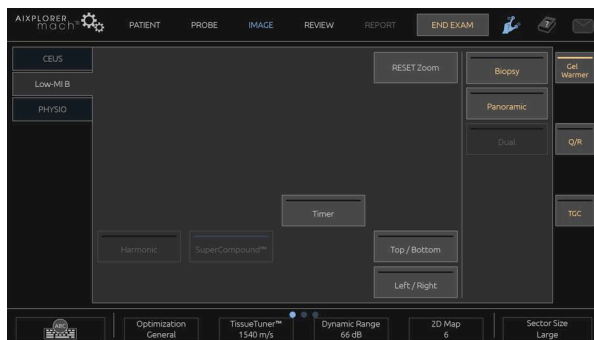

Low-MI B-mode touch screen parameters

Additional rotary controls are available at the bottom of the touch screen by swiping with one finger.

Description of CEUS Parameters

Contrast Agent

Contrast Agent control allows you to optimize several CEUS imaging parameters to better visualize specific commercially available microbubble contrast agents.

Press **Contrast Agent** to choose a commercially available microbubble contrast agent.

Optimization

Optimization acts on the CEUS image and allows you to change center frequency to obtain increased contrast resolution or increased penetration.

Optimization is available only in live imaging.

Rotate the knob located under **Optimization** to change its value:

- Resolution
- General
- Penetration

MVI

MVI allows you to visualize vascular architecture by tracing the movement of microbubbles.

Press the **MVI** button to activate.

Press the **MVI** button again to de-activate and clear the accumulated image display.

POI

POI displays a Point of Interest (POI) on both CEUS and Low-MI B-mode images.

Use the **SonicPad®** to move the POI across the image.

CEUS TGC

CEUS TGC allows the user to adjust the time-gain compensation of the CEUS display.

See above for more information on adjusting TCG controls.

CEUS Gain

CEUS Gain allows the user to adjust the overall gain of the CEUS image.

The CEUS gain control is the same knob as the B-mode gain knob while in CEUS mode.

To adjust image Gain in CEUS mode:

Rotate the **B** mode knob on the control panel when the mode indicator is labeled CEUS.

Timer

Timer allows you to start a clock which is used to record the time of microbubble contrast delivery.

Timer is available in live imaging only.

Press the **Timer** button to activate. The LED indicator will light.

Press the **Timer** button again to pause the clock.

Flash

Flash will send a limited number of high acoustic power frames into the ultrasound imaging sequence.

The **Flash** frames are intended to clear the imaging plane of microbubbles, allowing you to observe dynamic microbubble replenishment.

Flash is available in live imaging only. Press the Flash button to activate the delivery of the flash sequence.

CEUS Acoustic Power

CEUS Acoustic Power regulates the output power of the system delivered to the CEUS image.

Generally, very low acoustic power levels are used to avoid the unwanted destruction of fragile microbubble contrast agents.

CEUS Acoustic Power is available only in live imaging.

Rotate the knob located under **Acoustic Power**:

- clockwise to increase acoustic power output
- counterclockwise to decrease acoustic power output

Maximum acoustic power is 0dB and minimum is -30dB.

See [Chapter 3, Safety \[73\]](#) for information on output power regulations.

Flash Power

Flash Power regulates the output power of the system delivered to the CEUS image when the Flash control is pressed.

Generally, the Flash power is set to a high acoustic power level and is delivered in a just a few frames. The high Flash acoustic power will destroy microbubbles in the CEUS image, allowing you to observe dynamic microbubble replenishment.

Flash Power is available only in live imaging.

Rotate the knob located under **Flash Power**:

- clockwise to increase acoustic power output
- counterclockwise to decrease acoustic power output

See [Chapter 3, Safety \[73\]](#) for information on output power regulations.

CEUS Dynamic Range

CEUS Dynamic R. allows you to change the range over which the amplitudes of returning ultrasound signals are displayed in the CEUS image.

CEUS Dynamic R. is available in live CEUS imaging and on a frozen CEUS image.

Rotate the rotary knob located under **CEUS Dynamic R.:**

- clockwise to compress the grayscale values
- counterclockwise to decrease the dynamic range

CEUS Map

CEUS Map assigns the display of the CEUS echo signals to a range of grayscale or chromatic colors.

CEUS Map is available in live CEUS imaging and on a frozen CEUS image.

Rotate the rotary knob located under **CEUS Map:**

- clockwise to view next map
- counterclockwise to view previous map

Flash Duration

Flash Duration determines the duration of the Flash sequence.

Rotate the knob to adjust the desired time.

CEUS Scanning TIPS



CEUS SCANNING

Optimize the B-mode image as usual. Then press CEUS

Select the Contrast Agent setting most appropriate for the microbubble contrast agent being used.

Administer an amount of contrast agent advised by the contrast agent manufacturer for the targeted application.

Press Save Clip, when agent arrives to capture prospectively the contrast bolus.

Use a low CEUS Acoustic Power to minimize microbubble destruction.

Adjust the Optimization control to optimize the image.

Allow the contrast agent to completely clear before administering the dose appropriate for diagnostic imaging.

Remember to start the Timer when injecting contrast agent!

M-Mode Imaging

Accessing M-mode

Press M on the control panel from any other modes.

About M-Mode Main Display

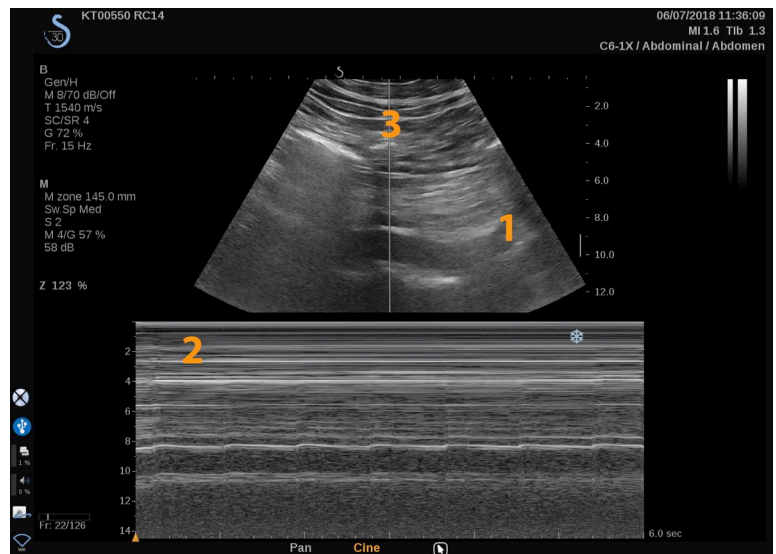

1. Grayscale image

2. M-mode

3. M line

About M-Mode touch screen

When in M-mode, the touch screen displays various image settings which help you to optimize your M-mode image.

These settings are controlled by touching the control on the touch screen or turning the rotary knob directly below it.

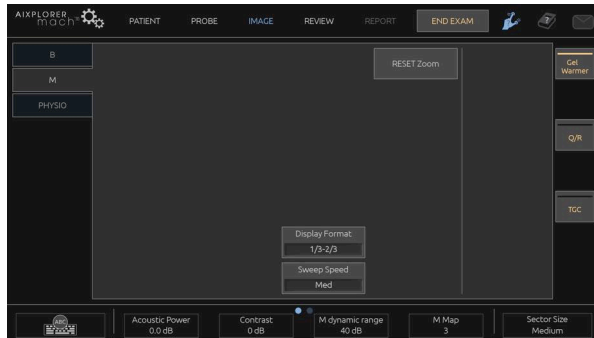

Additional rotary controls are available at the bottom of the touch screen by swiping with one finger.

Setting Up M-mode

M-line

Swipe left and right on the **SonicPad®** to move the M-line in the 2D image.

M-zone position

Swipe up and down on the **SonicPad®** to move the M-zone on the M-line

M-zone size

Swipe up and down using 2 fingers on the **SonicPad®** to change the size of the M-zone.

Description of M-mode Imaging Parameters

Res/PEN

Res/Pen allows you to change center frequency to obtain increased resolution or increased penetration. **Res/Pen** is available only in live imaging.

Rotate the knob located under **Res/Pen**.

- Left LED: Res (resolution)
- Middle LED: Gen (general)
- Right LED: Pen (penetration)

Acoustic Power

Acoustic Power indicates the output acoustic power.

Acoustic Power is available only in live mode.

Rotate the knob located under **Acoustic Power**:

- clockwise to increase acoustic power
- counterclockwise to decrease acoustic power

Acoustic Power values vary from 0dB (maximum power) to -20dB (minimum power).

M Dynamic Range

You can optimize the M-mode dynamic range as follows:

Rotate the knob located under **M Dynamic Range**:

- clockwise to increase the dynamic range
- counterclockwise to decrease the dynamic range

Contrast

Contrast is a display threshold of the M-mode.

Rotate the knob located under **Contrast**:

- clockwise to darken anechoic areas
- counterclockwise to brighten anechoic areas

Display Format

Display Format is available in live imaging and on a frozen image.

Press **Display Format** to change its value.

4 display formats are available:

- 1/3 B-mode and 2/3 spectral display
- B-mode and spectral side by side display
- ½ B-mode and ½ spectral display
- 2/3 B-mode and 1/3 spectral display

M Map

M Map is available in live imaging and on a frozen image.

Rotate the knob located under **M Map**:

- clockwise to go to next map
- counterclockwise to go to previous map

Sweep Speed

Sweep Speed allows you to change the speed with which the M-mode columns are updated on the display.

Sweep Speed is available in live imaging and on a frozen image.

Touch **Sweep Speed** until you reach the desired value.

Smoothing

Smoothing is a spatial filter used to smooth the M-mode in order to provide a more homogeneous appearance.

Smoothing is available only in live imaging.

Rotate the knob located under **Smoothing**:

- clockwise to increase smoothing
- counterclockwise to decrease smoothing

M-mode Scanning



M-MODE SCANNING

The M-mode will represent movements of structures along one line over time.

Initially a B-mode image is acquired.

Optimize the grayscale image by adjusting the image depth and zoom factor, and by setting the appropriate focal zone (position and spread).

Other optimization controls shall be used as necessary such as the Auto, the B-mode map, the overall gain and the dynamic range.

To activate the M-mode press the dedicated button on the control panel.

Set the proper size and positioning of the M zone.

Adjust the gain to optimize your M-mode spectrum by rotating the M-mode button.

The M-mode has a good temporal resolution, and the sweep speed may be adjusted if needed to match the speed of the movements that are observed.

The display format can be changed to match the user's working conditions.

ECG

The ECG module provided by Aixplorer® Mach 30 displays ECG signals as well as respiration signals. These signals are displayed on the main monitor, on top of the ultrasound image.

The ECG module allows to synchronize the ECG / Respiration signals with the ultrasound imaging modes, in order to select specific images in the cineloop based on ECG activity.

It can also help you detect heart arrhythmias based on electrical signals coming from the heart.

It can also help you measure time differences between specific electrical events on the ECG trace and anatomical events seen using the different Ultrasound imaging modes.



CAUTION

Make sure to inspect the ECG module daily.

Only use recommended cables with the ECG module.



WARNING

Do not use the physiological traces for diagnosis and monitoring. Note that in patients with cardiac pacemakers or implantable electrostimulators and in patients with arrhythmias, the heart rate may not be calculated correctly.

Remove the ECG electrodes from the patient before using devices such as high-frequency therapy equipment, electric scalpels, electrostimulators or electric defibrillators.

Do not allow the ECG electrodes to touch the patient's heart directly.

Setting up the ECG module

1. Plug the ECG cable to the dedicated port as follows:



2. Place the electrodes on the patient as indicated on the module



CAUTION

Please make sure the lead wire is connected to the trunk cable when setting up the ECG module.

3. Clip the lead on the electrodes as follows



How to properly position the ECG lead

Proper ECG lead placement is critical for receiving a good ECG tracing and respiration information. The lead shall be positioned correctly to maximize ECG and Respiration signal quality.

ECG lead colors are slightly different for the US (AHA) and rest of the world (IEC). The colors are identified in the table below.

	Right Arm (RA)	Left Arm (LA)	Left Leg (LL)
AHA	White Lead	Black Lead	Red Lead
IEC	Red Lead	Yellow Lead	Green Lead



NOTE

For information about how to clean the ECG module, please refer to [the section called “Cleaning and Disinfecting the ECG Module” \[416\]](#).

COMPATIBLE ECG CABLE

Following are the trunk cables recommended by SuperSonic Imagine:

Leads	Type	Manufacturer	Product Code
Philips ECG Trunk Cable	AHA	Unimed	AA-2385
Philips ECG Trunk Cable	IEC	Unimed	AA-2385-I

Following are the ECG leads recommended by SuperSonic Imagine:

Leads	Patient End	Type	Manufacturer	Product Code
Philips Reusable ECG LeadWires	Grabber	AHA	Unimed	AA3-90P
Philips Reusable ECG LeadWires	Grabber	IEC	Unimed	AA3-90P-I

Description of ECG parameters

The ECG feature is available in applications and presets via the **Physio** tab on the touch screen, but is activated by default only on the Cardiac preset with the P5-1X probe.

Two modes are available in the Physio tab: ECG and respiration. You can activate them one at a time, or both at the same time according to your needs.

Depending on the active mode (Green trace = ECG, Blue trace = Respiration), ECG parameters or Respiration parameters will be available.

ECG/Respiration parameters

The following parameters are available for both ECG and Respiration.

ECG/RESPIRATION GAIN

ECG/Respiration Gain allows you to adjust the amplitude of the trace(s).

You can change the amplitude by rotating the knob located below **ECG/Respiration Gain**.

ECG/RESPIRATION POSITION

ECG/Respiration Position allows you to move the trace position on the vertical axis.

You can move the trace position by rotating the knob located under **ECG/Respiration Position**

ECG LEAD

By pressing **ECG Lead** you can change the reference lead (Lead 1 by default) in order to maximize the signal quality.

INVERT ECG/RESPIRATION

Invert ECG/Respiration allows you to invert the active trace(s) up and down.

SWEEP SPEED

Sweep Speed allows you to change the speed at which the trace is displayed.

6 Analysing an image

Using body markers

How to use body markers

Body markers is available in live imaging and on frozen image.

Press **Annotate** on the control panel then Body markers on the touch screen to add a body marker to an image.



NOTE

You can also customize the access to **Body markers**. Please refer to [the section called “Customization” \[362\]](#)

The default body marker will appear on the on the touch screen and on the main monitor display to the lower right of the image.

Touch **PICTO** to change the body marker pictogram.

A selection of body markers appears on the touch screen.

Touch the desired body marker to select it.

The transducer orientation can be indicated directly on the pictogram.

To add a transducer orientation to the pictogram, simply touch the pictogram to indicate the edge of the transducer that corresponds to the orientation marker on the transducer.

Then touch the pictogram again to indicate the edge of the transducer opposite the orientation marker.

The transducer orientation appears. Use the **Rotate** knob to rotate the transducer orientation on the body marker.

Press **Exit** on the touch screen to close the Body Marker page.

Touch **HIDE** to hide the picto on the image.

To restore a body marker to the main display, touch **SHOW**.

Customization

You can customize the body marker libraries in the system configuration.

You can choose to display the body marker touch screen every time you press **Freeze**.

See [Chapter 9, Customizing the System \[355\]](#) for more information.

Using annotations

How to use annotations

You can add text annotations and arrows on an image to denote anatomical structures and locations. **Annotate** is located on the control panel.

The annotation feature is available in live imaging and on frozen image.

To annotate an image, press **Annotate** on the control panel.

A list of annotations appears on the touch screen and an annotation cursor appears on the main monitor display.

Rotate the **Page** knob to access various pages of annotations.

To add an annotation, you can choose from the following actions:

- Choose one of the pre-programmed annotations in the library of annotations. Touch the desired annotation to add it to the main display.
- Touch **Keyboard** to display a keyboard and manually enter an annotation.
- Touch **Arrow** on the touch screen to add an arrow graphic to the main display. Use the **SonicPad®** to position the arrow.

To remove annotations from the main display, use the following functions:

- **Clear All** removes all the annotations and arrows from the main display.
- **Delete Annot.** removes the annotation over which the text cursor has been positioned using the **SonicPad®**.
- **Del. Last Arrow** removes the last arrow marker applied to the image.

The annotations feature has some specialty controls to facilitate annotation workflow.

Annotation mode

When you add an annotation as a title, it will remain when you unfreeze the image.

When you add an annotation as a free annotation, it will be removed when you unfreeze the image.

Press **Mode** to change the annotation mode.

Group of annotations

Annotations can be grouped by color. If they have a specific color, they belong to the same group. When you select a first annotation from a group, it will be added to the screen. When you select an annotation from the same group, it will replace the one that is already on the screen, if it is from the same group. Annotations on transparent (blue) buttons do not belong to a given group. Therefore they will not be replaced. Annotations all appear in white when the image is saved or printed.

Moving annotations

You can move the annotations added to the screen:

1. Select an **annotation** from the touch screen to add it
2. Move the **cursor** over the newly added annotation
3. Click on the **SonicPad®**

The annotation is selected

4. Move the **cursor** where you want to move the annotation
5. Click on the **SonicPad®** to release the annotation



NOTE

If you move an annotation over an existing annotation, the existing annotation will be replaced.

Annotation Library

You can edit the library of pre-set annotations by manually entering your own. Touch **EDIT LIB.** to edit the library of annotations.

This opens the System Configuration page, the System/Display tab, and Annotation sub-tab.

Here you can manage the annotations for the desired clinical application.

See [Chapter 9, Customizing the System \[355\]](#) for more details.

Home

Touch **Home** to move the annotations cursor to the home position.

Touch **Set Home** to define the current position of the cursor as the Home position for the current display format.

Exit

Touch **EXIT** to exit annotations.

Customization

You can choose to display the annotation touch screen every time you press **Freeze**. See [Chapter 9, Customizing the System \[355\]](#) for more information.

Performing measurements

Accessing measurements

You can perform measurements to assess the dimension, area, perimeter, or volume of anatomical features.

Two types of measurements are available on Aixplorer® Mach 30:

- Basic measurements, which can be done with a set of measurement tools
- Labeled measurements, which correspond to the actual anatomy of the body. Labeled measurements are not linked to an image. They appear in the report even if the image on which they were performed is deleted.



WARNING

Make sure the image is correctly optimized before performing any measurements.

Press **Meas.** on the control panel to enter the measurement mode. A default caliper appears on the main display.

Note that the image area is duplicated on the touch screen to facilitate stylus measurements.

Measurements that appear with a star (*) are estimated measurement results.

Basic measurements

Touch **Meas. Tools** on the touch screen.

The system displays the measurement tools that are available for the active mode.

Measurement results are displayed in the Measurement ResultBox which is located to the lower right of the image, below the grayscale bar, on the main display. This ResultBox can be moved and placed all over the image.

In **Meas. Tools** you can press the **Reset ResultBox position** button to automatically replace the ResultBox to its initial place.

Touch the desired measurement tool:

Distance

Distance is available in all modes.

Method 1: with the SonicPad®

1. Touch **Distance**.
2. Use the **SonicPad®** to move the active cursor to the first measurement point.
3. Click on the **SonicPad®** to anchor the first point. The system anchors the first cursor and displays a second active cursor. The system displays the value of distance in the measurement result area to the right of the image on the main display.
4. Touching **End** will end the measurement.

Method 2: with the Touch Screen

1. **Touch Distance**.

The active cursor appears.

2. Touch the image on the touch screen where you want to anchor the first cursor. The system moves the cursor to the position indicated, anchors the first cursor, and displays a second active cursor.

3. Touch the image on the touch screen where you would like to position the second cursor.
4. Touch **End** to anchor the second cursor.

It is possible to combine the approaches of Method1 and Method2 to optimize the measurement workflow.

Ellipse

Ellipse is available in all modes.

Method 1: with the SonicPad®

1. Click on the **SonicPad®** to anchor the first point. The system anchors the first cursor and displays a second active cursor.
2. Use the **SonicPad®** to move the active cursor to the second point of measurement.
3. Click on the **SonicPad®** to anchor the second cursor. The system displays an ellipsoid trace between the two points.
4. Use the **SonicPad®** to adjust the shape of the ellipse.
5. Clicking on the **SonicPad®** will sequentially arbitrate control to the first cursor, second cursor and ellipse trace.
6. Touch **End** to complete the measurement.

Method 2: with the Touch Screen

1. Touch **Ellipse**. The active cursor appears.
2. Touch the image on the touch screen where you want to anchor the first cursor. A second cursor will automatically appear.
3. Without lifting the finger or stylus, drag the second active cursor along the axis of the ellipse. The system displays an ellipsoid trace between the two points. Lifting the stylus or finger will anchor the second cursor.
4. Touch the image near the opposite axis of the ellipse.
5. Without lifting the finger or stylus, drag the ellipse trace to the desired position.
6. Touch **End** to complete the measurement.

It is possible to combine the approaches of Method1 and Method2 to optimize the measurement workflow.

Trace

Trace is available in all modes.

Method 1: with the SonicPad®

1. Touch **Trace**.
2. Use the **SonicPad®** to move the active cursor to the first measurement point.
3. Click on the **SonicPad®** to anchor the first point. The system anchors the first cursor and displays a second active cursor directly on top of the first.
4. Use the **SonicPad®** to move the active cursor to the second measurement point. The path will be displayed.
5. Click on the **SonicPad®** to anchor the second cursor. The system will automatically connect the end points of the trace.
6. Alternately, touch **End** to complete the measurement.

If the start and end points of the trace become very near to each other, the system will automatically close the trace.

The knob under **Trace** can be used on an active trace to incrementally erase the trace in reverse and redo the trace.

Method 2: with the Touch Screen

1. Touch **Trace**

The active cursor appears.

2. Touch the image on the touch screen where you want to anchor the first cursor.

A second cursor will automatically appear directly on top of the first.

3. Without lifting the finger or stylus, drag the second active cursor along the path of the desired trace.

The path will be displayed.

Lifting the finger will pause the trace.

Touching the cursor will reactivate the trace.

4. Touch **End** to complete the measurement. If the start and end points of the trace become very near to each other, the system will automatically close the trace.

Depth

This tool allows you to define the depth on the image at a particular point of interest.

To access depth calculation, press **Meas. Tools**.

1. Press **Depth**
2. Anchor it at the desired point
3. The depth value will be displayed.

Volume

A three distance volume allows you to use three independent distances in the same or in orthogonal images to create a volume calculation.

To access volume calculation, press **Meas. Tools**.

1. Press **Volume**
2. Use your preferred method (see above, Distance measurements) to draw three distances
3. The system calculates a volume from the three distances

You can also calculate a volume with labeled measurements. See [the section called “Labeled measurements” \[301\]](#).

Ellipse distance volume

1. Press **Meas. Tools** on the touch screen

2. Press **Volume (Ellipse + Distance)**
3. Use your preferred method to draw an ellipse on the plane of interest
Once the ellipse is drawn, the system displays the first caliper of a distance measurement.
4. Choose an orthogonal plane to draw the distance
Once the distance is drawn, the system displays the values of the volume in the measurement result area.

Hip angle

Hip Angle allows you to calculate the angles between the roof line and the baseline (α), and between the inclination line and the baseline (β).

To access hip angle calculation, press Meas. Tools.

1. Press Hip Angle
2. Draw the baseline as a regular distance
3. Draw the roof line as a regular distance

α is calculated

4. Draw the inclination line as a regular distance

β is calculated.

d:D

d:D allows you to calculate the coverage of the femoral head by the bony acetabulum.

To access femoral head coverage calculation, press **Meas. Tools**.

1. Use the **SonicPad®** to position the circle at the center of the femoral head
2. Click on the **SonicPad®**
3. Use the **SonicPad®** to resize the circle to fit the femoral head D is calculated.
4. Draw the baseline as a regular distance

d is calculated.

The d:D ratio is calculated.

IMT

IMT calculates the Intima Media Thickness of a region of interest.

Press **IMT** to start the measurement.

A box of interest is displayed on the image, the intima and media are automatically traced within the box of interest and the IMT measurement is displayed in the measurement result area.

- **IMT** indicates the Intima Media Thickness
- **W** indicates the width of the box of interest
- **Fit** indicates the percentage of the box of interest for which the IMT is calculated

Use the **SonicPad®** to move the box of interest.

Click on the **SonicPad®** to be able to resize and rotate the box of interest. The box of interest is outlined with a dotted line.

Use the **SonicPad®** to resize the box of interest.

Use the **SonicPad®** to rotate the box of interest.

Click on the **SonicPad®** again to exit the resize/rotate mode.

You have access to various parameter to optimize the IMT calculation:

IMT OPT

Allows you to select between various detection algorithms, as a function of the visually estimated IMT.

Rotate the knob under **IMT Opt** to change its value.

IMT DISPLAY

Rotate the knob under **IMT Display** to hide or show the IMT trace on the image.

ZOOM

Rotate the knob under zoom to zoom the image that is duplicated on the touch screen.

EDITION OF THE IMT TRACE

You may want to slightly change the IMT trace.

1. Press **Edit Intima** or **Edit Media** as needed
2. Move the cursor to modify the trace
3. Turn off **Edit Intima** or **Edit Media** to exit the edition of the IMT trace

MANUAL REDEFINE

You may want to manually draw the IMT trace.

1. Press **Manual Redefine**
2. Press **Redefine Intima** or **Redefine Media** as needed
3. The Intima or Media trace is erased a cursor appears
4. Move the cursor to manually draw the Intima or Media
5. Press **Exit Manual Redefine** to exit the Manual Redefine mode

Draw backwards to erase the trace.

Press **Exit IMT** to exit.

B-mode ratio

B-mode Ratio allows you to compare the brightness of two regions of interest (ROI) on the same image.

B-mode Ratio is available only in B-mode, on a frozen image.

1. Scan in **B-mode**
2. Optimize the image quality (especially by applying an Auto TGC)
3. Press **Freeze**
4. Touch **B-mode Ratio**
5. A circle is displayed that can be resized and moved using the **SonicPad®**
6. Place the circle within the defined region of interest
7. Click on the **SonicPad®** to anchor it
8. Another circle is displayed, that can be resized and moved using the **SonicPad®**
9. Place it on the second region of interest, at the same depth as the first one
10. Click on the **SonicPad®** to anchor it
11. The value of each ROI, their depth, their diameter and the Ratio between the two regions is displayed.



NOTE

In case of B-mode ratio use in the context of Hepato-Renal Index assessment, the following instructions are recommended:

1. Perform a B-mode image of the right liver with the kidney following the usual guidelines.
2. Apply an AutoTGC.
3. By following the previous B-mode ratio instructions of use, place the first ROI on the liver parenchyma near kidney interface (the ROI diameter should only include the liver parenchyma).
4. Press **Select**, then place the second ROI on the renal cortex (by avoiding the medulla and the pyramid layers) at the same depth-related attenuation for both organs (the ROI diameter should only include the renal cortex).
5. The value of each ROI, their depth, their diameter and the Ratio between the two regions are displayed.

% diameter reduction

This tool allows you to compare the diameter of the unreduced vessel to the diameter of the stenotic or reduced lumen.

1. Press **% Diam Reduction**
2. Move the cursor at the first point of the residual diameter
3. Click on the **SonicPad®** to anchor it
4. Move the next cursor to the second point of the residual diameter
5. Click on the **SonicPad®** to anchor it
6. Move the next cursor to the first point of the vessel diameter
7. Click on the **SonicPad®** to anchor it
8. Move the next cursor to the second point of the vessel diameter
9. Click on the **SonicPad®** to complete the measurement

The system calculates the vessel diameter, the residual diameter, and the reduction between the two.

% area reduction

Two tools allow you to compare a cross-sectional outline of the unreduced vessel to a tracing of the stenotic or reduced lumen.

Ellipse Method

1. Press **% Area Reduction (Ell)**
2. Use the ellipse to define the vessel area
3. Click on the **SonicPad®**
4. Use the **SonicPad®** to draw the residual area
5. Click on the **SonicPad®** to complete the measurement

Trace Method

1. Press **Meas. Tools** on the touch screen
2. Press **% Area Reduction (Trace)**
3. Move the cursor to the first point of the residual area
4. Click on the **SonicPad®** to start drawing

5. Use the **SonicPad®** to draw the residual area
6. Click on the **SonicPad®** to validate
7. Move the next cursor to the first point of the vessel area
8. Click on the **SonicPad®** to start drawing
9. Click on the **SonicPad®** to complete the measurement

The system calculates the vessel area, the residual area, and the reduction between the two.

Distance ratio

1. Press **Distance Ratio**
2. Perform a first distance measurement
3. Perform a second distance measurement The system calculates a ratio between the two distance measurements.

Follicle counting

Follicle counting allows you to count and measure the follicles within each ovary.

1. Scan in B-mode
2. Make sure the image quality is sufficient in order to detect the follicles within the ovary
3. **Freeze** the image
4. Select the frame that contains the maximum number of follicles



NOTE

Not all follicles may be visible in the same frame. Repeat the whole procedure in different frames if needed.

5. Press **1-distance**, **2-distance** or **3-distance** (in 3D) **Follicle** on the touch screen in order to measure a first follicle
6. A cursor appears
7. Click to start the measurement procedure

8. When the measurement of a follicle is completed, it appears in the follicle list
9. Repeat the procedure to measure several follicles
10. The total number of follicles appear on the top of the follicle list



NOTE

Click on **Right Ovary** or **Left Ovary** before performing the follicle measurement. The follicle measurements and counting data is integrated in the report. In 3D, click on the follicle you want to measure on each plane in order to center it so that it is visible on each plane.

Ejection fraction

Ejection Fraction allows you to calculate the ejection fraction from the change in the left ventricular volume between diastole and systole (monoplane Modified Simpson method). The left ventricular volumes are calculated from traces of the endocardium performed at end diastole and end systole.

1. Obtain an apical four chambers or two chambers view with the P5-1X
2. Optimize the image as needed
3. Press **Freeze**
4. Use the **SonicPad®** to select the best diastolic frame
5. Press **Meas.** on the control panel
6. Select the **A4Cd LV** or **A2Cd LV** measurement in the labeled measurements list
7. Use the **SonicPad®** to move the first caliper on the first point of the mitral annulus
8. Click on the **SonicPad®** to anchor it
9. Trace the left ventricular border up to the second point of the mitral annulus
10. Click on the **SonicPad®** to anchor it
11. Use the **SonicPad®** to adjust the long axis as needed
12. Click on the **SonicPad®** to anchor it

13. Perform the same operations on the best systolic frame (**A4Cs LV** or **A2Cs LV** measurement)



NOTE

The Ejection Fraction is calculated with the monoplane Modified Simpson method.

Doppler time

This tool is available in UltraFast™ Doppler mode and cardiac preset.

It allows you to calculate time shifts between 2 timelines and compare the temporal behaviors of multiple spectrograms or to measure basic Doppler Time in PW and CW on the cardiac preset.

1. Add UltraFast spectrograms (see [the section called “Add Spectrogram” \[222\]](#)) or perform PW Trace in cardiac
2. Press **Meas Tools** on the touch screen
3. Press **Doppler Time**
4. Position the first timeline
5. Click on the **SonicPad®** to validate
6. Position the second timeline
7. Click on the **SonicPad®** to validate

The Doppler time shift is displayed in the measurement result area, in milliseconds.

PW autotrace

See [the section called “PW Autotrace” \[235\]](#).

Velocity

Velocity is available only in PW mode.

1. Touch Velocity. A Vel caliper is displayed on the PW spectrum, together with a vertical axis and a horizontal axis.
2. Click on the **SonicPad®** to anchor the caliper.

The **Velocity** tool results in a Doppler Velocity (Vel) measurement (in cm/s) and a Pressure Gradient (PG) calculation (in mmHg).

PSV/EDV

PSV/EDV is available only in PW mode.

1. Touch **PSV/EDV**. A first PSV caliper is displayed on the PW spectrum, together with a vertical and a horizontal axis.
2. Click on the **SonicPad®** to anchor it.

A second caliper is displayed, with the following label:

- EDV if the caliper is above the baseline
- MDV if the caliper is below the baseline

3. Click on the **SonicPad®** to anchor it.

The **PSV/EDV** tool results in the following:

- Peak Systolic Velocity (PSV)
- End Diastolic Velocity (EDV)
- Resistive Index (RI)
- Systolic to Diastolic Ratio (S/D)
- Peak Pressure Gradient (PG)

Doppler 2 Velocity Ratio

Doppler 2 Velocity Ratio is available in PW and CW modes on the Cardiac preset.

1. **Touch 2 Velocity Ratio.**

A first Vel caliper is displayed on the PW spectrum, together with a vertical and a horizontal axis.

2. Click on the **SonicPad®** to anchor it.

- A second Vel caliper is displayed
3. Click on the **SonicPad®** to anchor it.

The **Doppler 2 Velocity Ratio** tool results in the following:

- Velocity (Vel 1)
- Max Pressure Gradient 1 (Max PG 1)
- Velocity 2 (Vel 2)
- Max Pressure Gradient 2 (Max PG 2)
- Vel 1/Vel 2 Ratio (Vel 1/Vel 2)
- Doppler Angle (Angle)
- SV Depth (SV Depth)

Vessel diameter

Vessel Diam allows you to measure the diameter of a vessel.

Vessel Diam is available only in PW mode.

1. Touch **Vessel Diam**.

A first caliper is displayed within the sample volume

2. Use the **SonicPad®** to resize the first part of the caliper
3. Click on the **SonicPad®** to anchor

A second caliper is displayed within the sample volume

4. Use the **SonicPad®** to resize the second part of the caliper
5. Click on the **SonicPad®** to anchor.

Doppler slope

Doppler Slope allows you to measure the acceleration or deceleration slope on the Doppler spectrum.

Doppler Slope is available in PW mode.

1. Touch **Doppler Slope**.

A first caliper is displayed

2. Click on the **SonicPad®** to anchor the first caliper

The system anchors the first caliper and displays a second active caliper

3. Use the **SonicPad®** to move the active caliper
4. Click on the **SonicPad®** to anchor the second caliper

Doppler time-slope

Doppler Time-Slope allows you to measure the acceleration or deceleration slope on the Doppler spectrum.

Doppler Time-Slope is available in PW and CW modes.

1. Touch **Doppler Time-Slope**.

A first caliper is displayed

2. Click on the **SonicPad®** to anchor the first caliper

The system anchors the first caliper and displays a second active caliper

3. Use the **SonicPad®** to move the active caliper
4. Click on the **SonicPad®** to anchor the second caliper

Doppler trace

Doppler Trace allows you to trace a single heart cycle on the Doppler spectrum.

Doppler Trace is available in PW and CW modes.

1. Touch **Doppler Trace**.
2. Use the **SonicPad®** to move the active caliper to the first measurement point.
3. Click on the **SonicPad®** to anchor the first point.

The system anchors the first caliper and displays a second active cursor.

4. Use the **SonicPad®** to move the active caliper along the desired path.

The path will be displayed.

5. Click on the **SonicPad®** to anchor the second caliper.

Congestion index

Congestion Index allows you to calculate the ratio between the cross-sectional area (cm^2) and the blood flow velocity (cm/s) of the portal vein.

1. Adjust the **Angle correction** parallel to the portal vein
2. Click on the **SonicPad®** to update the PW spectrum
3. **Freeze** the image
4. Touch **Congestion Index**
5. Adjust the portal vein diameter by positioning the first and second caliper with the **SonicPad®**
6. Draw the Doppler trace during one cardiac cycle
7. Click on the **SonicPad®** to end the measurement

Heart rate

This tool allows you to measure a heart rate from M-mode, PW and CW.

1. In M-mode or PW measurement, touch **Heart Rate**.

A first vertical line is displayed.

2. Use the **SonicPad®** to move the vertical line on the beginning of one heart cycle.
3. Click on the **SonicPad®** to validate.

A second vertical line is displayed.

4. Use the **SonicPad®** to move the second vertical line on the end of the same cardiac cycle.
5. Click on the **SonicPad®** to validate.

IMPORTANT

In OB/GYN the vertical lines have to be positioned on two cardiac cycles to get the correct heart rate.

Volume flow

In PW mode, you have the capability to measure the volume flow rate within a vessel.

1. Adjust the Sample Volume size so that it covers the whole diameter of the vessel
2. Adjust the **Angle correction** parallel to the vessel
3. Click on the **SonicPad®** to update the PW spectrum
4. **Freeze** the image
5. Press **Meas.** on the Control Panel
6. Press **Volume Flow** on the Touch Screen
7. Adjust the vessel diameter by positioning the first and second caliper with the **SonicPad®**
8. Draw the Doppler trace during one cardiac cycle
9. Click on the **SonicPad®** to end the measurement

The system displays the volume flow rate.

When the Autotrace is on:

1. Press **Volume Flow**
2. Adjust the vessel diameter by positioning the first and second caliper with the **SonicPad®**

The system displays the volume flow rate.

M distance

This tool allows you to measure a vertical distance between two calipers.

It is similar to a distance measurement in B-mode.

1. In M-mode measurement, touch **M Distance**.

A first caliper is displayed.

2. Use the **SonicPad®** to move the first caliper
3. Click on the **SonicPad®** to validate.

A second caliper is displayed.

4. Use the **SonicPad®** to move the second caliper
5. Click on the **SonicPad®** to validate.

M time-slope

This tool allows you to measure a vertical distance between two calipers.

It is similar to a distance measurement in B-mode.

1. In M-mode measurement, touch **M Time-Slope**.

A first caliper is displayed.

2. Use the **SonicPad®** to move the first caliper
3. Click on the **SonicPad®** to validate.

A second caliper is displayed.

4. Use the **SonicPad®** to move the second caliper
5. Click on the **SonicPad®** to validate.

Q-Box™

The Quantification Box (Q-Box™) allows you to accurately quantify the stiffness of an area.

Q-Box™ is available only in SWE™ mode, on a frozen image.

1. Touch **Q-Box™**

Q-Box™ displays a circle that can be resized or moved, and that is duplicated on the B-mode image (in side by side and top bottom formats), for reference purposes.

2. Select to anchor it.

Q-Box™ ratio

Q-Box™ Ratio allows you to compare the stiffness of two areas on the same image.

Q-Box™ Ratio is available only in SWE™ mode, on a frozen image.

1. Touch **Q-Box™ Ratio**.

Q-Box™ Ratio displays a circle that can be resized or moved, and that is duplicated on the B-mode image (in side by side and top bottom formats), for reference purposes.

2. Place the **Q-Box™** within the stiffest visualized area
3. Click on the **SonicPad®** to anchor it
4. Another **Q-Box™** is displayed.
5. Place it on soft tissue.
6. Click on the **SonicPad®** to anchor it.

Q-Box™ trace

Q-Box™ Trace allows you to manually trace a Q-Box in SWE imaging mode in order to obtain some elasticity values within the traced area.

Q-Box™ Trace is available only in SWE™ mode, on a frozen image.

1. Touch **Q-Box™ Trace**
2. Use your preferred method (with the SonicPad®, or with the touch screen, see [the section called “Trace” \[282\]](#)) to draw a trace
3. Click on the **SonicPad®** to end the measurement

Multi Q-Box™

Multi Q-Box™ allows you to automatically calculate the average of several Q-Box measurements.

Multi Q-Box™ is available only in SWE™ mode, on a frozen image.

1. Touch **Multi Q-Box™**
2. Resize and move the Q-Box as needed
3. Click on the **SonicPad®** to validate
4. If you want to add an other Q-box, repeat the operation The system calculates the average of each Q-Box result. You can continue the Multi Q-Box measurement cycle on several images.
5. Press **End** to end the Multi Q-Box measurement cycle

SWE Stability Index

The SWE stability index tool (labelled **SI** in the Q-Box results) allows you to assess the temporal consistency of the SWE estimates within the Q-Box. It is available in the Abdomen, Liver and Vascular Abdominal presets of the C6-1X probe.

1. Press **Probe**
2. Select the **Liver** preset in the Abdominal application on the C6-1X transducer
3. Optimize the B-mode image on the liver right lobe
4. Make sure the patient is holding his/her breath
5. Press **SWE** and optimize as needed
6. **Freeze** the image
7. Perform a Q-box measurement of the imaged tissue
8. If the displayed stability index is <90%, this suggests temporal variability, and therefore you may have to set the Q-Box to another location within the SWE box or restart the acquisition.



CAUTION

A stability index >90% does not validate the elasticity accuracy.

The Stability Index must be analyzed only in the presets/probe mentioned above.

If necessary, the Stability Index tool can be disabled in the system configuration.

Other touch screen measurement functionalities

The measurements touch screen has some specialty controls to facilitate measurement workflow.

Erase all

Erase All allows you to erase all of the measurements displayed on the frozen image.

Erase last

Erase Last allows you to erase only the last caliper anchored.

End

End will end the active measurement.

Undo/Redo

The knob under **Undo/Redo** can be used on an active trace to incrementally erase the trace in reverse and redo the trace.

Zoom

Zoom allows you to enlarge the size of the image area displayed on the touch screen.

Rotate the knob located under **Zoom**:

- clockwise to increase the zoom factor
- counterclockwise to decrease the zoom factor

Use “Fit” to fit the image in the touch screen measurement area.

Assign last

Assign Last allows you to assign the last measurement performed to a label.

1. Perform a measurement
2. Touch Assign Last on the touch screen

The system displays the list of available labels for your measurement

3. Click on the desired label

For more information on labeled measurements, refer to [the section called “Labeled measurements” \[301\]](#)

Exit

Exit completes any active measurements, closes the measurements touch screen and returns to the frozen image state.

Labeled measurements

Press **Meas.** on the control panel.

A list of labeled measurements is displayed on the right side of the image.

The available labels depend on the selected application and on the current active mode.

The label packages can be configured in the System Configuration. See [the section called “Packages” \[392\]](#).

Press **Cursor**.

To scroll the list, place the **cursor** over it, and scroll on the **SonicPad®**.

Pick the appropriate label from the list by using the **SonicPad®**.

The appropriate measurement tool is launched (distance...).

Perform the measurement as for a basic measurement.

You can make up to 5 measurements for the same label. They appear with their corresponding caliper in the list.



NOTE

Labeled measurements may be hidden, depending on the selected option from the system configuration.

Measurement customization

You can customize the measurements in the system configuration.

You can choose to display the measurement touch screen every time you press **Freeze**.

See the [Chapter 9, Customizing the System \[355\]](#) for more information.

Measurement accuracy

Transducer information

Transducer name	Geometry	Nominal center frequency	Imaging frequency range
L18-5	Linear	8.5 MHz	4.0 - 15 MHz
L10-2	Linear	6.0 MHz	2.0 - 10.0 MHz
LH20-6	Linear	11 MHz	6.0 - 20.0 MHz
C6-1X	Curved	3.5 MHz	1.0 - 6.0 MHz
C9-2X	Curved		2.0 - 9.0 MHz
E12-3	Micro-convex	7 MHz	3.0 - 12.0 MHz
LV16-5	Motorized	8.5 MHz	5.0 - 16.0 MHz
MC12-3	Micro-convex	7.5 MHz	3.0 - 12.0 MHz
P5-1X	Phased	2.9 MHz	1.0 - 5.0 MHz

2D measurements

The table below shows the measurement accuracy and range for the 2D measurements available on the ultrasound system.

Measurement type	Accuracy	Range	Notes
Axial distance	+/- 10% or 1mm	0.01 to 25 cm	Whichever is larger
Lateral distance	+/- 10% or 2mm	0.01 to 20 cm	Whichever is larger
Diagonal distance	+/- 10% or 2mm	0.01 to 25 cm	Whichever is larger
Area	+/- 10% or 25mm ²	0.01 to 1000 cm ²	Whichever is larger ^a
Perimeter	+/- 10% or 5mm	0.03 to 10,000 cm	Whichever is larger ^b
Ellipsoid volume	+/- 10%	0.01 to 2000 cm ³	Whichever is larger
Ejection fraction (calculated)	+/- 20%	10% to 80%	Whichever is larger ^c

^aContinuous trace accuracy depends on user.

^bContinuous trace accuracy depends on user.

^cContinuous trace accuracy depends on user.



NOTE

The tolerances specified apply only to measurements made in a homogeneous medium with a speed of sound of 1540m/s and with non-refractive surface and with insonification angle of 90 degrees relative to the surface of the transducer.

Panoramic distance measurements

Metric	Specification	Test level	Notes
Transducer name / preset	L18-5 / General	I	1
Panoramic distance measurement accuracy	+/- 10%	M	3

Metric	Specification	Test level	Notes
Transducer name / preset	L10-2 / General	I	1
Panoramic distance measurement accuracy	+/- 10%	M	3

Explanation of symbols used in the panoramic distance measurements tables:

Test Level I: Verified by inspection or qualitative analysis.

Test Level M: Verified by measurement.

Note 1: Specification is for information purposes only, and is not a testable requirement at the system level.

Note 2: Specification refers to the ultrasound pulses used in the imaging part of the B-mode sequence.

Note 3: The Panoramic distance measurement accuracy test is performed using the ATS 551 Small Parts phantom and covers a maximum distance of approximately 20 cm.

M-mode measurements

Metric	Specification	Test level	Notes
Transducer name / preset	C6-1X / OB	I	1
M-mode TX/RX frequency	2.4/4.5 MHz	I	1, 2
Axial distance measurement accuracy	+/- 10% or 1mm	M	3, whichever is greater
Heart rate measurement accuracy	+/- 10%	M	4

Metric	Specification	Test level	Notes
Transducer name / preset	E12-3 / OB	I	1

Metric	Specification	Test level	Notes
M-mode TX/ RX frequency	3.7/7.5 MHz	I	1, 2
Axial distance measurement accuracy	+/- 10% or 1mm	M	3, whichever is greater
Heart rate measurement accuracy	+/- 10%	M	4

Explanation of symbols used in the M-mode measurements tables:

Test Level I: Verified by inspection or qualitative analysis.

Test Level M: Verified by measurement.

Note 1: Specification is for information purposes only, and is not a testable requirement at the system level.

Note 2: Specification refers to the ultrasound pulses used in the M-mode sequence.

Note 3: The M-mode distance measurement accuracy test is performed using the CIRS Model 040GSE phantom.

Note 4: The fetal heart rate timing accuracy is measured using the following material: AWG Agilent 33220A Oscilloscope Tektronix DPO4034 Ultrasound Gel Pad Aquaflex Ref. 04-02 HI-FI speaker Monacor SP60/4.

AXIAL DISTANCE ACCURACY

Table 6.1. Axial distance measurement accuracy - acceptance criteria and measurement results

Transducer	Acceptance criteria	Measurement results							
	Maximal axial distance error	Preset	Setting	TX/RX frequency (MHz)	Range (cm)	Calibrated distance	Measured distance (mm)	Error	Test result
E12-3	10%	Early OB	Fund	9/7.5	0.01 to 8.5	10	9.5	5%	Pass
C6-1X	10%	Abdomen	THI	1.875/3.75	0.01 to 20	10	9.7	3%	Pass

TIMING ACCURACY

Table 6.2. Timing accuracy - acceptance criteria and measurement results

Transducer	Acceptance criteria	Measurement results							
	BPM error	Preset	Setting	TX/RX frequency (MHz)	Range (bpm)	Periods per minute (scope)	Measured BPM	Error	Test result
E12-3	10%	Early OB	Fund	6.42/6.42	16-100	180	180	0%	Pass
C6-1X	10%	Early OB	THI	2.8/5.6/3.75	16-100	180	180	0%	Pass

Doppler measurements

Doppler measurement calipers are positioned on a single pixel in a desired location. Velocity measurements are displayed in units of cm/s or m/s with at least 1 digit past the decimal point. The table below shows the measurement accuracy, range and tolerance for the Doppler measurements available on the ultrasound system.

Doppler measurement	System tolerance (whichever is greater)	Accuracy based on	Range (r)
Velocity measurement	<15% relative error	Acquisition	PW: 6.2 cm/s - 370 cm/s

The tolerances specified apply only to measurements made in a homogeneous medium with a speed of sound of 1540 m/s and with a non-refractive surface and a Doppler angle of 0°. These accuracies arise from the positioning of the cursors on the Doppler display and the subsequent measurements made.

MEASUREMENT DOPPLER ACCURACY AND SENSITIVITY SUMMARY FOR THE TRANSDUCERS

Items marked by a dagger (†) indicate that the specified value is for information purposes only and is not a testable requirement at the system level.

Test Level I: verified by inspection or analysis

Test Level M: verified by measurement

† : for reference only

(1) Transmitter center frequencies for grayscale imaging

(2) Using CIRS 043 Doppler string phantom.

Table 6.3. Doppler Velocity Accuracy measurements in Aixplorer® Mach 30 for the L18-5 transducer

Metric (notes)	Specification	Test level
Transducer name / preset	L18-5 / Breast	I
PW Doppler center frequency	5MHz	I
PW Doppler spectral velocity accuracy (2)	=12.5% error	M

Table 6.4. Doppler Velocity Accuracy measurements in Aixplorer® Mach 30 for the C6-1X transducer

Metric (notes)	Specification	Test level
Transducer name / preset	C6-1X / Abdomen	I
PW Doppler center frequency	2.25 MHz	M
PW Doppler spectral velocity accuracy (2)	=13% error	M

Table 6.5. Doppler Velocity Accuracy measurements in Aixplorer® Mach 30 for the E12-3 transducer

Metric (notes)	Specification	Test level
Transducer name / preset	E12-3 / Prostate	I
PW Doppler center frequency	4.5MHz	I
PW Doppler spectral velocity accuracy (2)	=15% error	M

Table 6.6. Doppler Velocity Accuracy measurements in Aixplorer® Mach 30 for the LV16-5 transducer

Metric (notes)	Specification	Test level
Transducer name / preset	LV16-5 / Breast	I
PW Doppler center frequency	5MHz	I
PW Doppler spectral velocity accuracy (2)	=5% error	M

Table 6.7. Doppler Velocity Accuracy measurements in Aixplorer® Mach 30 for the L10-2 transducer

Metric (notes)	Specification	Test level
Transducer name / preset	L10-2 / Vascular - Carotid	I
PW Doppler center frequency	3.75 MHz	I
PW Doppler spectral velocity accuracy (2)	=3% error	M

Table 6.8. Doppler Velocity Accuracy measurements in Aixplorer® Mach 30 for the MC12-3 transducer

Metric (notes)	Specification	Test level
Transducer name / preset	MC12-3 / General - Vascular	I
PW Doppler center frequency	4.5MHz	I
PW Doppler spectral velocity accuracy (2)	=14.5% error	M

Table 6.9. Doppler Velocity Accuracy measurements in Aixplorer® Mach 30 for the LH20-6 transducer

Metric (notes)	Specification	Test level
Transducer name / preset	LH20-6 / MSK	I
PW Doppler center frequency	7.5MHz	I
PW Doppler spectral velocity accuracy (2)	=15% error	M

Table 6.10. Doppler Velocity Accuracy measurements in Aixplorer® Mach 30 for the P5-1X transducer

Metric (notes)	Specification	Test level
Transducer name / preset	P5-1X / Vascular - TCD	I
PW Doppler center frequency	1.875 MHz	I
PW Doppler spectral velocity accuracy (2)	=15% error	M

Color Flow Doppler sensitivity

The purpose of this test is to measure the penetration of color flow imaging performance. Each transducer is placed in Color Flow. The Color Flow Doppler Phantom equipped with a 4 mm diameter sloping cylindrical vessel is imaged to measure the Color Doppler Sensitivity in centimeters. The Doppler angle is approximately 72°. The maximal depth (penetration) at which the Doppler signal can be detected on the display is measured using the calipers with one caliper at skin line and the other where the color flow signal starts to show dropouts. The distance between them is considered to be the penetration. The flow signals that fall below the threshold are considered to be noise and are not valid Color Doppler signals. The Color Flow Doppler Phantom is used with a constant flow waveform. (1) Transmitter center frequencies for grayscale imaging (2) Using Shelley medical accuFlow-Q pump with QATP — 100/Z Model (Zerdine™ tissue mimicking material speed of sound 1540 m/s ± 6 m/s at 22°C, attenuation coefficient 0.5 dB/cm/MHz) blood flow phantom set at minimal, maximal, and midrange Doppler mean velocities output.

Table 6.11.

Metric (notes)	Specification	Test level
Transducer name / preset	L18-5 / Breast	I
Color Flow frequency range	5 - 9 MHz	M
Color penetration	41 mm	M
Angio PL.U.S. penetration	48 mm	

Table 6.12.

Metric (notes)	Specification	Test level
Transducer name / preset	C6-1X / Abdominal	I
Color Flow frequency range	2 - 2.5 MHz	M
Color penetration	12.5 cm	M
Angio PL.U.S. penetration	125 mm	

Table 6.13.

Metric (notes)	Specification	Test level
Transducer name / preset	E12-3 / Prostate	I
Color Flow frequency range	4.5 - 7.5 MHz	M
Color penetration	5.0 cm	M

Table 6.14.

Metric (notes)	Specification	Test level
Transducer name / preset	LV16-5 /	I
Color Flow frequency range	5 - 9 MHz	M
Color penetration	4.0 cm	M

Table 6.15.

Metric (notes)	Specification	Test level
Transducer name / preset	L10-2 / LowExtVenous	I
Color Flow frequency range	3.7 - 6.4 MHz	M
Color penetration	62 mm	M
Angio PL.U.S. penetration	71 mm	

Table 6.16.

Metric (notes)	Specification	Test level
Transducer name / preset	MC12-3 / Vascular	I
Color Flow frequency range	4.5 - 7.5 MHz	M
Color penetration	5.0 cm	M

Table 6.17.

Metric (notes)	Specification	Test level
Transducer name / preset	LH20-6 / MSK	I
Color Flow frequency range	6.4 - 9 MHz	M
Color penetration	3.5 cm	M

Table 6.18.

Metric (notes)	Specification	Test level
Transducer name / preset	P5-1X / TCD	I
Color Flow frequency range	2.2 - 2.5 MHz	M
Color penetration	2.0 mm	M

Elastography measurements

SWE PENETRATION AND SPATIAL RESOLUTION

The tables below document the penetration depth, and SWE spatial resolution specifications for all transducers where the SWE mode is available.

Table 6.19.

Metric (notes)	Specification	Test level	Notes
Transducer name / preset	LV16-5 / General	I	1
SWE penetration depth range	2.5 - 28 mm	M	4
SWE spatial resolution	2.0 mm	M	5

Table 6.20.

Metric (notes)	Specification	Test level	Notes
Transducer name / preset	L18-5 / General	I	1
SWE penetration depth range	2.5 - 30 mm	M	4
SWE spatial resolution	2.0 mm	M	5

Table 6.21.

Metric (notes)	Specification	Test level	Notes
Transducer name / preset	L10-2 / General	I	1
SWE penetration depth range	2.5 - 45 mm	M	4
SWE spatial resolution	2.0 mm	M	5

Table 6.22.

Metric (notes)	Specification	Test level	Notes
Transducer name / preset	LH20-6 / General	I	1
SWE penetration depth range	1 - 20 mm	M	4
SWE spatial resolution	2.0 mm	M	5

Table 6.23.

Metric (notes)	Specification	Test level	Notes
Transducer name / preset	E12-3 / General	I	1
SWE penetration depth range	2.5 - 30 mm	M	4
SWE spatial resolution	2.0 mm	M	5

Table 6.24.

Metric (notes)	Specification	Test level	Notes
Transducer name / preset	MC12-3 / General	I	1
SWE penetration depth range	2.5 - 30 mm	M	4
SWE spatial resolution	3.0 mm	M	5

Table 6.25.

Metric (notes)	Specification	Test level	Notes
Transducer name / preset	C6-1X / General	I	1
SWE penetration depth range	25 - 70 mm	M	4
SWE spatial resolution	2.0 mm	M	5



NOTE

If the user considers the shearwave velocity measurement, the error of 15% or 1 m/s whichever is greater should be taken into account.

If the user considers the Young's modulus measurement, the error of 30% or 3 kPa whichever is greater should be taken into account.

Explanation of symbols used in the SWE penetration and spatial resolution tables:

Test Level I: Verified by inspection or qualitative analysis.

Test Level M: Verified by measurement.

Note 1: Specification is for information purposes only, and is not a testable requirement at the system level.

Note 2: Specification refers to the ultrasound pulses used in the imaging part of the SWE sequence.

Note 3: The SWE maximum penetration depth is defined as the greatest depth for which the SWE image exhibits good color filling and minimal noise. The LV16-5, L18-5, L10-2, LH20-6, E12-3, MC12-3 and C6-1X SWE penetration depth ranges were derived by scanning regions of uniform-elasticity background material of the CIRS 049A QA Elasticity phantom.

Note 4: SWE spatial resolution is obtained by using a custom-made phantom containing rectangular tissue-mimicking blocks of different elastic contrast, and measuring the average width of the shear wave velocity vs. distance curves in the vicinity of the block interfaces in the lateral and axial directions.

3D measurements

Transducer	Mode TX/RX frequencies	Depth (mm)	Transverse resolution (mm)
LV16-5	THI	20	1.3

The volume measurement accuracy is defined at $\pm 10\%$ in the range of 0.01 to 2000cm³.

BI-RADS® analysis

The Breast Imaging Reporting and Data System (BI-RADS®), developed by the American College of Radiology, provides a standardized classification for ultrasound studies of the breast. It is composed of a series of descriptors, from which an assessment linked to a category can be made by the physician.

BI-RADS® assessment categories

Table 6.26. The American College of Radiology BI-RADS® assessment categorization for ultrasound

BI-RADS® score	Assessment
0	Assessment incomplete: need additional imaging evaluation
1	Negative
2	Benign finding
3	Probably benign finding
4	Suspicious malignancy
4a	<i>Low suspicion for malignancy</i>
4b	<i>Moderate suspicion for malignancy</i>
4c	<i>High suspicion for malignancy</i>
5	Highly suggestive of malignancy
6	Known biopsy-proven malignancy



NOTE

All BI-RADS criteria are displayed in English on the system, regardless of the selected language.

You can easily perform BI-RADS® classification using the integrated BI-RADS® Lexicon Classification form. Up to twelve lesions may be classified in a single study.

Performing BI-RADS® lexicon classification

1. In any mode, **freeze** the image.
2. Touch **Add New Lesion**.

A new lesion touch screen button will appear (e.g. Lesion A).

3. Using the **SonicPad®**, position the lesion arrow marker to indicate the lesion of interest on the main display.
4. Click on the **SonicPad®** to anchor the arrow marker.

The BI-RADS® menu will appear to the left of the image on the main display.

5. Select the results in the BI-RADS® lexicon classification form using the **Cursor** and the **SonicPad®**
6. Click on the **NEXT** button in the menu or the **Lesion Page** control on the touch screen to move to the next page of the BI-RADS® menu.
7. Press **Save Image**.
8. Touch **Exit** to close the BI-RADS® menu.



NOTE

Important note:

You must press **Save Image** after filling out the BI-RADS® classification form and exiting the menu or the data will not be saved.

The BI-RADS® menu can be accessed as many times as needed to complete the assessment for a particular lesion. Measurements performed while in the BI-RADS® menu will be directly associated with the Lesion selected (e.g. Lesion A) in the final report. Measurements performed in the BI-RADS® menu will appear on page 4.

Documenting BI-RADS® lexicon classification with images

A single image is not able to document all of the features contained in the BI-RADS® lexicon classification form.

To assist in documentation of lesion features, the integrated BI-RADS® menu offer you the advantage of documenting one or more BI-RADS® features with an associated image.

1. Define a new lesion and activate the BI-RADS® menu.

2. Using the **cursor** and the **SonicPad®**, results may be selected in the BI-RADS® lexicon classification form.
3. Press **Save Image**.

Note that the image number appears to the right of the selected answer on the BI-RADS® lexicon classification form.

4. You may exit BI-RADS® after each **Save Image** and return to the same lesion to enter additional data associated with new images.
5. In the case that disparate results are entered for the same lesion, reconciliation of results can be done in the Report (see **Chapter 7, Reports [321]**).

Thy-RADS™ Analysis

The Thyroid Reporting and Data System (Thy-RADS™), developed by SuperSonic Imagine, provides a set of clinical assessment criteria for ultrasound studies of the thyroid.

You can easily perform Thy-RADS™ analysis using the integrated Thy-RADS form.

Up to 8 nodules may be classified in a single study.

Performing Thy-RADS™ lexicon classification

1. In the Thyroid application, freeze the image.
2. Touch **Thy-RADS**.
3. Touch **Add new Nodule**.

A new nodule touch screen button will appear (e.g. Nodule A).

4. Using the **SonicPad®**, position the nodule arrow marker to indicate the nodule of interest on the main display.
5. Click on the **SonicPad®** to anchor the arrow marker.

The Thy-RADS™ menu will appear to the left of the image on the main display.

6. Select the results in the Thy-RADS™ lexicon classification form using **Cursor** and the **SonicPad®**
7. Click on the **NEXT** button in the menu or the **Nodule Page** control on the touch screen to move to the next page of the Thy-RADS™ menu.
8. Press **Save Image**.
9. Touch **Exit** to close the Thy-RADS™ menu.



NOTE

Importante note:

You must press **Save Image** after filling out the Thy-RADS™ classification form and exiting the menu or the data will not be saved.

The Thy-RADS™ menu can be accessed as many times as needed to complete the assessment for a particular nodule. Measurements performed while in the Thy-RADS™ menu will be directly associated with the Nodule selected (e.g. Nodule A) in the final report. Measurements performed in the Thy-RADS™ menu will appear on page 4.

Documenting Thy-RADS™ lexicon classification with images

A single image is not able to document all of the features contained in the Thy-RADS™ lexicon classification form. To assist in documentation of lesion features, the integrated Thy-RADS™ menu offer you the advantage of documenting one or more Thy-RADS™ features with an associated image.

1. Define a new nodule and activate the Thy-RADS™ menu.
2. Using the **Cursor** and the **SonicPad®**, results may be selected in the Thy-RADS™ lexicon classification form.
3. Press **Save Image**.

Note that the image number appears to the right of the selected answer on the Thy-RADS™ lexicon classification form.

4. You may exit Thy-RADS™ after each **Save Image** and return to the same nodule to enter additional data associated with new images.
5. In the case that disparate results are entered for the same lesion, reconciliation of results can be done in the Report (see **Chapter 7, Reports [321]**).

7 Reports

Description of the report feature

The Aixplorer® Mach 30 ultrasound system allows you to manage all the informations collected during the study and generate a report.

The Report features is composed of two different views:

- the Report Builder, which allows you to create and customize the report
- the Report Preview, which allows you to view the report as it will be printed or generated as pdf file

Press **Report** to access the report feature.

The Report Builder is displayed.

Report builder

Description of the report builder

The Report Builder allows you to choose which elements of the examination are to be included in the final report.

The Report Builder is composed of the following tabs:

- **Patient Info**, where you can retrieve/edit patient informations
- **Images**, where the images acquired during the exam, associated measurements, BI-RADS®/Thy-RADS™ and comments are stored
- **Measurements**, where you can view all the labeled measurements and calculations of the exam
- **Worksheet**, where you can visualize the constitutive elements of the final report, modify patient information and patient data entry, use diagram or anatomical data to locate or precise the performed labeled measurements
- **Conclusion**, where you can add your conclusion of the exam

Patient information

The Patient Info tab displays the patient information, which is populated with the same information as the Patient Data screen.

As with the Patient Data screen, the **Patient Information** tab displays general information, as well as further information specific to each clinical application.

You can edit all the information from the Patient Information tab.

You can enter information in more than one tab if multiple applications have been used.

If you press **Patient** to return to Patient Data entry, all your edits from the Report Builder will be saved and updated.

You can choose what information to show in the final report by using the Show/Hide Info icons:

- Selecting the Show Info icon will designate that information to appear in the final report
- Selecting the Hide Info icon will designate that information to not appear in the final report

Information which is hidden in the final report always remains part of the study as stored on the ultrasound system.

Images

The Images tab in the Report Builder displays all of the images acquired in the exam.

The images are organized into clinical application tabs.

Vertical tabs are dedicated to images associated with BI-RADS® and Thy-RADS™ table.

You can choose which images to show in the final report by selecting them.

Click on the icon above the image to have it included in or excluded from the report.

Images which are not shown in the final report always remain part of the study as stored on the ultrasound system.

Next to each image is a text box designated for comments.

Select the white text box next to the image for which you want to add comments.

Enter comments using the **Keyboard**.

Measurements associated with each image are shown in the area to the right.

You can choose to show/hide the measurements in the final report by using the Show/Hide Info icons:

- Selecting the **Show Info** icon will designate the measurements to appear in the final report
- Selecting the **Hide Info** icon will designate the measurements to not appear in the final report

If no measurements were performed on the set of selected images, the region may appear empty.



NOTE

For OB images on which labeled measurements were performed, click on **GRAPH** to display the growth chart corresponding to the selected reference table.

Measurements

The **Measurement** tab allows you to view the labeled measurement results and associated calculations performed during the exam.

In this tab, you can show or hide each label measurement result in the final report.

1. Select the desired application sub-tab (available only for applications in which label measurements were performed during the exam).

Note that even if the image on which the labeled measurements were taken was deleted, the corresponding labeled measurements are kept in the database.

2. You can show or hide each labeled measurement result individually with the checkbox next to each measurement.

Hidden labeled measurement results will not appear in the final report.

For multiple instances of the same measurement, you can select which instance will be displayed in the report. Click on the + to display all the sub-results of the performed measurements.

Worksheet

The **Worksheet** tab is divided in sub-tabs corresponding to the applications and presets used to perform the exam.

For all applications, the Worksheet displays the informations contained in the Patient Data Entry and the Patient Information tab. It includes diagrams and clinical informations for Breast, Genito Urinary and Thyroid, and Area of pain for MSK. The measurements are also displayed and BI-RADS or THY-RADS if they have been performed.

For the Vascular and OB-GYN applications, the Worksheet tab displays the labeled measurements performed in an interactive report or on Anatomical Data.

OB-Gyn worksheet

The OB-GYN **Worksheet** displays Exam information, Fetus condition information and the labeled measurements performed in the OB-GYN application on an interactive report.

OB PERCENTILES AND Z-SCORES

OB Estimated Fetal Weight percentile and Growth Percentile data are used to interpret and manage fetal growth. EFW percentile data

is presented along with the calculated EFW as determined by using data from peer-reviewed publications and the gestational age. Growth percentile data is presented along with fetal measurements as determined by using data from peer-reviewed publications and the gestational age. The display of this data allows the clinician to assess fetal growth and manage the pregnancy.



CAUTION

Be careful to confirm the patient name and ID before starting an examination for a new patient.

Check the date format before entering date of birth, Last Menstrual Period (LMP), Estimated Date of Delivery (EDD), Date Of Conception (DOC) and Ovulation Date. Incorrect entry of these parameters will result in an incorrect Gestational Age (GA).

Enter the EDD and GA in the patient's medical record for backup.

Check the "Activate OB calcs" button on the Patient Data Entry page (PDE) in order to perform obstetric calculations.

It is necessary to specify which OB author is to be used for each particular measurement to calculate the GA and get an Estimated Fetal Weight (EFW).

A diagnosis can not be only based on one measurement or data. Be careful to always consider the overall clinical evaluation of the patient, including the medical record.

Depending on fetal position, some measurements may be incorrect. Be careful to always consider the overall clinical evaluation of the patient, including the medical record.

The system provides fetal measurements for up to five fetuses. Be careful not to confuse the fetuses during measurements.

For each measurement performed, you can select either the first, last, average, minimum, maximum or specifically one of the five measurements that are allowed to be displayed, using the selector feature in the Measurements tab of the Report.

Be careful when deleting measurements, as this will affect the selector result.

Deviations from the normal values of measurements must be judged based on the graphs and literature.

1. Perform obstetrical labeled measurements
2. The Measurements appear in the report together with the indication of the percentile and Z-score (based on the selected reference table, author and date)

OB TRENDING

The OB trending allows you to assess the evolution of the fetus as a function of time, for exams that are stored on the system.



CAUTION

Make sure the "Activate OB calcs" option is checked in the Patient Data Entry in order to use percentiles and Z-scores.

1. Enter patient data in the Patient form



CAUTION

Make sure at least the Patient First Name, Last Name and Date of Birth match the previous exams so that the system recognize the same patient.

2. At the bottom of the Patient form, a window displays the previous exams for the same patients
3. Select the previous data for the current patient
4. The previous data for the current patient is imported in the system
5. Start the exam and perform the current measurements
6. Save images as needed
7. Press **Report**
8. For each measurement, the data of the previous exam(s) and the current exam are displayed on a same graph

Vascular worksheet

DESCRIPTION

The Vascular **Worksheet** displays the labeled measurements performed in the vascular application and presets on Anatomical Data.

ADDING INFORMATION TO THE WORKSHEET

You can add some information to each worksheet such as scan quality or clinical findings.

1. Click on the text field next to the corresponding label

The keyboard automatically opens up

2. Type text to enter additional information

You can add labeled measurement results, annotations, plaque shapes and arrows to each worksheet.

1. Press **Toolbox** on the touch screen

A window opens up on the main display

2. Click on the information you want to add.

Annotate

1. Press **Annotate** in the tool box

An annotation box is displayed on the worksheet.

2. Use the keyboard to edit it
3. Click on the annotation and use the **SonicPad®** to move the annotation box if needed.
4. Double-click on the annotation box to rotate it if needed

Arrows are displayed around the annotation box.

5. Use the **SonicPad®** to rotate the annotation box
6. Click on the **SonicPad®** to validate.

Plaque shape

1. Click on the plaque shape you want to add in the tool box
2. Click on the plaque shape and use the **SonicPad®** to move it if needed
3. Click on the **SonicPad®** to validate.
4. Double-click on the plaque shape to resize or rotate it if needed Arrows are displayed around the plaque shape.
5. Use the **SonicPad®** to rotate the plaque shape
6. Click on the **SonicPad®** to validate.

Add arrow

1. Click on an element on the worksheet to link it to the Anatomical Data with an arrow
2. Press **Add arrow** in the tool box
3. Click on the added arrow
4. Use the **SonicPad®** to move the tip of the arrow to the selected location on the Anatomical Data
5. Click on the **SonicPad®** to validate.

REMOVING INFORMATION FROM THE WORKSHEET

1. Click on the element you want to remove
2. Press **Toolbox** on the touch screen
3. Click on **Remove** on the tool box.

ADDITIONAL INFORMATION SPECIFIC TO THE CAROTID WORKSHEET

The Carotid worksheet provides the SRU1 and NASCET2 criteria at the bottom of the worksheet.

Click on the elements that apply to the findings to add them to the worksheet.

Liver worksheet

The Liver Worksheet provides you with a summary table of all Q-Box Liver labeled measurements performed on the liver, with detailed information for each Q-Box measurement.

In order to obtain this Q-Box Liver Worksheet:

1. After a SWE acquisition, press **Meas.** on the control panel
2. Select the **Liver SWE** measurement package on the touch screen
3. The list of available Q-Box Liver SWE labeled measurements appear on the right side of the screen
4. Use any of the labeled measurements
5. Press **Save Image**
6. Press **Report**
7. Click on the **Worksheet** tab

The Liver Worksheet also provides you with the capability to select a publication to visualize SWE statistics for reference.



NOTE

Those measurements are not from the exam. They are extracted from the selected publication and are shown for reference only.

1. Click on the arrow to visualize the list of available publications
2. Click on the publication of interest
3. The related table is displayed below and will appear in the final report.

Conclusion

The **Conclusion** tab in the Report Builder is a free-form text entry screen.

Enter any final information or conclusions about the exam here.

You can choose to show the conclusion in the final report by using the Show/Hide Info icons:

- Selecting the **Show Info** icon will designate that conclusion to appear in the final report
- Selecting the **Hide Info** icon will designate that conclusion to not appear in the final report

Generating reports

Press **Generate Report** to generate the desired report in .pdf.

Use the **cursor** and the **SonicPad®** to navigate between pages.

Printing reports

If you are satisfied with the report preview, you can print a hard copy of the report.

Touch the **Print Report** button on the touch screen to send the report to a configured printer.

If a hard-copy printer is not available, the Report will not be sent.

Exporting reports

An option allows you to export the report as DICOM images. This can be used in particular when your PACS does not support viewing of pdf.

1. Press **System Config.**
2. Open the **Administration** tab
3. Open the **Devices** sub-tab
4. Add or edit an existing DICOM store
5. In the **Advanced Options** tab, enable the Report Export
6. In the drop-down list, select the **Ultrasound image** option
7. Click on **OK** to validate

8 Image and Data Management

Saving Data

Capturing Images and Clips

You can capture and save a single image, or a clip sequence. Clips can be captured retrospectively or prospectively. The captured frame or clip sequence is saved in the patient study, and a thumbnail is available in the live imaging display and the Review display. During capture, an icon is displayed at the bottom of the display. When the capture is complete, a thumbnail of the image is displayed.

Capturing a single Image

1. Press **Freeze**
2. Press **Save Image**

The image appears in the thumbnail strip on the right side of the screen.

Capturing a Retrospective Clip Sequence

The Aixplorer® Mach 30 allows you to capture retrospective clips.

1. Press **Freeze**.
2. Press **Save Clip** when frozen to save the images in the clip sequence just acquired.

When the capture is complete an audible beep will confirm that the clip was saved.

The clip appears in the thumbnail strip on the right side of the screen.

Do not press **Review** until you hear the beep.

Capturing a Prospective Clip Sequence

The Aixplorer® Mach 30 allows you to capture prospective clips in live imaging.

1. Press **Save Clip** during live imaging initiates a prospective clip capture.

Prospective clip capture will automatically complete after the duration specified in the System Configuration.

When capture is complete an audible beep will confirm that the clip was saved.

2. Press **Save Clip** again or **Freeze** to stop the capture.

Do not change the scaling of the image during the prospective clip capture, especially the following settings:

- **Digital Zoom**
- **Display Format**
- **Dual Top/Bottom**
- **Wide Image mode**

On a DICOM review workstation, changing the scaling of the image may result on possible inaccurate measurements performed afterwards on DICOM prospective clips.

3. The clip appears in the thumbnail strip on the right side of the screen.

Do not press **Review** until you hear the beep.



NOTE

Pressing **Save Image** while acquiring a prospective clip does not stop the prospective clip acquisition.

Setting up the duration of a prospective clip capture

See [???](#). To set up the duration of a prospective clip capture:

Choose the desired duration of prospective clip captures from the available options:

2 sec, 5 sec, 10 sec, 15 sec, 30 sec, 1, 2, 3, 4, 5 min

Note: a specific duration may be set for contrast mode.

Trimming Clips

Trim allows you to discard frames from the start or end of a prospective or retrospective clip.

1. Press **Trim** on the touch screen.

The SonicPad® is arbitrated to **Trim End**.

2. Position the **SonicPad®** towards the beginning of the clip to discard the required frames from the end of the clip

The **SonicPad®** is arbitrated to Trim Start

3. Move the **SonicPad®** towards the end of the clip to discard the required frames from the start of the clip
4. Turn **Trim** off to cut the trimmed frames out.
5. Press **Save Clip** to save a new clip without the trimmed out frames.

If needed, press **Trim Reset** to return the Trim Start and Trim End frames to the start and end of the acquisition, respectively.

Reviewing an Exam

During or after an exam, use Review to examine and compare images acquired in the exam. Multiple exams for one patient may be reviewed. In Review, you can look at the images or clip sequences that have been stored. Stored images can be viewed, sent, printed, searched and backed up. Image analysis can also be performed in Review. Images that are stored on the ultrasound system hard-drive can be sent to a DVD, USB media, or on DICOM-compatible devices on a network.

General Information on Review

In Review mode, a variety of tasks may be completed, including performing measurements and playing clip sequences.

MEASUREMENTS IN REVIEW

In Review mode, measurements on images in the current exam can be performed. An image must first be displayed in full size. Measurements made in Review on the current exam can be saved in the report. Measurements made in Review on prior exams cannot be saved. To display the measurement controls on the Review Exam touch screen, press **Meas**. Clear all measurements from an image by touching **Erase all** on the Review Exam touch screen.

Starting Review

Press **Review** to enter Review mode.

The display that appears depends on whether an exam is active on the system.

If an exam is in progress, pressing **Review** opens the Review Exam display.

If there is not an exam currently in progress when **Review** is selected, the Patient Directory will be displayed.

If an automatic deletion is set up in the system configuration, you can lock some exams to prevent them from being automatically deleted.

To return to live imaging, press **Review** again.

Patient Directory

The Patient Directory is a list of exams that are stored on the selected disk drive. The Patient Directory includes options that allow the user to sort,

view, and transfer exams. If no current exam is in progress when Review is started, Patient Directory is displayed.

ABOUT PATIENT DIRECTORY HEADERS

In the Patient Directory, exams are organized in a table containing several columns. Each column header describes the contents of that column using either text or an icon. Click on a column header to sort the list by this column. The Exam Status column displays the number of times an exam has been continued (if any).

Selecting and Loading Exams

If an exam is currently in progress, pressing Review opens the Review Exam display with images loaded from the current exam.

If no exam is in progress, pressing **Review** opens the Patient Directory display, which lists previous exams.

To review previous exams, first select an exam in the Patient Directory.

Multiple exams of the same patient may be selected and loaded for review.

To select all exams click **Select All**

Click **Display Selected** to load the selected exams for viewing

VIEWING IMAGES

The Review Exam display is used for viewing and comparing exam images in the selected layout. Thumbnail images for the current or selected exam appear on the right side of the display. The touch screen display provides access to other review functions.

PRINTING IMAGES IN REVIEW

You can print images from the image review.

1. Click on each image you want to print in the desired order
2. Click on Print

NAVIGATING THUMBNAILS OF IMAGES

In Review small images, called thumbnails, can be viewed.

Thumbnails are located on the right side of the Review Exam display.

Touch **Previous thumbnail** and **Next thumbnail** on the Touch Screen to navigate through thumbnails of images. This will display the previous or the next image in full screen review mode.

Putting the cursor over a thumbnail makes it expand to a larger dimension.

Clicking on the thumbnail image will make it expand to its real size.

Clicking on the garbage icon over a thumbnail deletes that image.

COMPARING IMAGES

In Review, two images from different exams of the same patient may be compared.

1. Select the two exams in the Patient Directory
2. Click **Display Selected**.
3. Click on the patient name on the left side Thumbnails of the two exams will appear.
4. Select the two images to be reviewed and touch **Compare**.

The two images appear side by side. They can be reviewed at the same time and measurements and annotations can be performed.

Printing images

For environmental purposes, print only when necessary.

Use digital devices for storage.

You can print to an integrated printer (option) or to printers on a network.

The system allows you to configure print controls and printers.

Printing in Live Imaging

You can print live or frozen images during an exam.

1. Acquire the desired image
2. Press **Save Image** on the control panel

Images will be printed according to the printers that are associated and configured (see [Chapter 9, Customizing the System \[355\]](#)).

PRINTING STORED IMAGES TO A LOCAL PRINTER

From the review exam display, you can print stored single and multi frame images, one at a time, from 1 to 15 images per page.

1. Press **Review**
2. Select an exam
3. Press **Display Selected**
4. In the Review Exam display, select images you want to print



NOTE

The print order will follow the selection order. Click on the images you want to print in the order you want them printed

5. Select which printer to use with the appropriate knob on the touch screen
6. Select the desired layout with the next knob
7. Touch **Print**.

IMPORTANT

In order to configure the network, you must connect the network cable at the back of Aixplorer® Mach 30 to a local area network first.

PRINTING STORES IMAGES TO A DICOM PRINTER (OPTIONAL)

In the Review Exam display, you can send single-frame images from the system to DICOM-printers.

1. Press **Review**
2. Select an exam
3. Touch **Display Selected**
4. In the Review Exam display, select one or more images
5. Touch **Export to DICOM**
6. In the Send To dialog box, select a DICOM printer
7. Click **OK** to print the selected images

To configure your DICOM Printer, see [the section called “Devices” \[369\]](#)

Printing Images in review

You can print images from the image review.

1. Click on each image you want to print in the desired order
2. Click on Print

Sending a Study

Export Formats

In Review, specific images can be pushed to DICOM printers (optional) and servers on a network, to a CD/DVD, or to a USB device. The format

can be chosen before sending images or clips. To send an enlarged image to a printer or USB device, see [Chapter 9, Customizing the System \[355\]](#).

Sending Images

In the Review Exam display, images can be pushed from the system to DICOM compatible printers and servers on a network. Also, images can be sent to the DVD drive on the system.

1. In the Review Exam display, select one or more images
2. Touch **Export to DICOM** or **Export as JPEG/H264**
3. In the Send To dialog box, select a destination

In the Send To dialog box, the total space, as well as the free space available on the device are displayed for a USB device.



NOTE

Check the Image de-identification checkbox in the Send To dialog box to send the image(s) with identification fields cleared from the database and the image.

4. Click OK to send the selected images

The exams will be exported into folders organized by patient name.

To eject a CD/DVD:

1. Click on the appropriate icon (CD or DVD)
2. Follow the instructions that appear on the screen

If you need to manually eject the CD/DVD, insert a paper clip in the hole located right next to the CD/DVD player.

To eject a USB device:

1. Wait until the  symbol (exporting data to USB) is replaced by  in the notification icons area

2. Remove the USB device



CAUTION

Ensure that both the user and the patient do not place hands or any other body parts on or in the USB port.

At anytime, you can check the export status, by clicking on the appropriate notification icon on the left side of the screen. For information on icons, refer to [the section called “Notification Icons” \[177\]](#).

Clinical Data Export (optional)

With the Aixplorer® Mach 30, you have the capability to manage your own clinical trials by exporting data in 2 different formats.

The **User’s Club** format allows you to export anonymized images and measurements together in order to post them in your clinical study (User’s Club tool).

The **Excel** format allows you to export un-anonymized measurements in order to utilize the data in a spreadsheet.

The **Excel** file will contain all the measurements that have been performed during the exams.

For several measures realized with the same measurement tool, the average and the median values will be automatically calculated and displayed.

To export data:

1. Plug a USB device
2. Press **Review** to access the Patient Directory
3. Select the exam(s) you want to export
4. Touch **Clinical Data Export** on the touch screen
5. Select an export format
6. Select your device

7. Press **Start**

The systems exports your data in the selected format on your USB device. For more information on the User's Club: www.KT30club.com [<http://www.KT30club.com>]

DICOM Structures Reporting (DICOM SR)

The DICOM Structured Report is a document architecture designed for encoding and exchanging clinical information and findings in the context of Radiology imaging. The DICOM SR is supported for OB-GYN and Vascular clinical applications on the Aixplorer® Mach 30.

For the OB-GYN application it uses the NEMA's Template ID 5000 OB-GYN Ultrasound Procedure Report.

For the Vascular application it uses the NEMA's Template ID 5100 Vascular Ultrasound Procedure Report.

One image/clip acquired within the OB-GYN or Vascular clinical application will trigger the creation of a DICOM SR report.

By default, the Aixplorer® Mach 30 will not generate DICOM structured Reports at the end of the exam.

CONFIGURATION

DICOM Structured Report (SR) option

In order to activate the DICOM SR feature:

1. Press **System Config**.
2. Open the **Device Settings** tab
3. Open the **System DICOM options** sub-tab
4. Check the **Generate Structured Reports** checkbox

DICOM Store

1. In the System Configuration, click on the **Devices** sub-tab of the Administration tab
2. Click on **Edit Selected**
3. Click on the **Advanced options** of your DICOM store device
4. Select the **Enable Export of SR** checkbox of your choice

DICOM Removeable media

1. In the System Configuration, click on the **Devices** sub-tab of the Administration tab
2. Click on the **DICOM Removeable media**
3. Click on **Edit Selected**
4. Select the **Enable Export of SR** checkbox of your choice

SENDING METHODS

Automatic Send of DICOM SR Reports

When the export of SR is enabled for one or several DICOM Store devices, a DICOM SR file will be sent automatically at the end of the exam to this/these configured DICOM Store devices.

Send On Demand of DICOM SR Reports

During a live examination, and if the export of SR is enabled for one or several DICOM Store devices, you may send on demand updated versions of the DICOM SR report to this/these configured DICOM Store devices.

1. Press **Review** or **Report**
2. Press **Send SR** on the touch screen

Manual Send of DICOM SR Reports

1. When an exam is ended, click on **Review**
2. Select the exam for which you want to send the SR, and press **Display Selected**
3. In the Review Image List, click on the **DICOM SR icon**
4. Press **Export to DICOM** on the touch screen
5. Select the device and click on **OK**



NOTE

You can configure all your DICOM exportation settings. See [the section called “Devices” \[369\]](#)

Deleting exams and images

The Patient Directory allows you to delete exams from the system.

If an exam is accidentally deleted, and the exam has been archived to a DVD, the archived exam can be re-loaded.

In the Review Exam display, stored images from an exam can be deleted.

This is only possible, however, when Send Images/Clips in Print/Network setups is set to At End of Exam.

When an image is deleted, it remains temporarily in the Review Exam display with an X marked through it.

To delete one or more images

1. Select the images to be deleted
2. Touch **Delete Selected** on the touch screen
3. Click on **Delete** in the confirmation box

To delete exams

1. In the Patient Directory, select one or more exams. To select all exams, touch **Select All**
2. Click **Delete Selected**
3. Click on **Delete** in the confirmation box

Image Query and Retrieve

Prior to, or during an exam, a query may be performed to find patient exams located on a remote workstation, external USB media, or CD/DVD.

Qualified images can be extracted from these exams and retrieved by the Aixplorer® Mach 30.

Once retrieved, the images can be browsed, and an appropriate image can be selected for Review.

A retrieved image may also be displayed in a side-by-side manner next to a live image in the current exam.

Important: The Query and Retrieve feature requires the Aixplorer® Mach 30 system is connected to a network hosting a DICOM compliant image archive workstation.

General Information about Query-Retrieve

If there is no current exam, a query may be performed for any number of studies from the workstation.

These studies can be retrieved by the Aixplorer® Mach 30 in preparation for upcoming new exams.

If there is a current exam in progress, the query will attempt to find prior exams of the current patient (if the automatic Q/R was configured).

Valid types to be retrieved are as follows:

- DICOM Ultrasound images
- DICOM Ultrasound images extracted from ultrasound clips
- DICOM images from a variety of modalities: Computed Radiography (CR), Computed Tomography (CT), Magnetic Resonance (MR), Nuclear Medicine (NM), Secondary Capture (SC), X-Ray Angiographic (XA), Radio Fluoroscopy (RF), Mammography (MG)

Please consult your workstation user's manual, the workstation DICOM conformance statement or your workstation/PACS administrator for assistance with secondary captures.

Any retrieved exam can be displayed along with a live image in a current exam.

However, if there are mismatches in patient identification characteristics between the current exam and the retrieved exam, a warning will be displayed.



FOR MORE INFORMATION ON DICOM

For more information on DICOM, have a look at our DICOM Conformance Statement and IHE Statement on our website:

<http://www.supersonicimagine.com/dicom>

<http://www.supersonicimagine.com/ihe>

Refer to **the section called “Notification Icons” [177]** for Query-Retrieve notification icon.



CAUTION

Displaying a patient with a different patient identification to that in the current exam must be done with caution.

This feature is provided in the event of a patient name change, or hospital ID change.

The operator assumes all risk when performing query retrieve operations on Aixplorer® Mach 30.

Retrieved images can be very helpful when used for reference comparison to the same feature of interest in the live ultrasound image.

Use caution when reviewing retrieved images on Aixplorer® Mach 30, as they may be compressed or displayed at a lower level of image quality than observed on the PACS workstation.

Images retrieved and displayed on the Aixplorer® Mach 30 are not intended to be used for sole diagnosis.



NOTE

You may also push studies from your PACS workstation to your Aixplorer® Mach 30 system.

Performing a Query

Automatic Query

If configured, the system can perform an automatic query of various types of exams for a given patient.

When the exam is started for a given patient, press **Save Image** to save a first image for this patient.

The system automatically performs a query on the selected patient.

Press the **Q/R** button on the control panel to view the queried exams.

See [Chapter 9, Customizing the System \[355\]](#) for more details.

Manual Query

Press the **Q/R** button to initiate an exam query.

The query dialog box will appear.

Click on the tab on which you want to query:

- Patient Name (Name)
- Patient ID (ID)
- Accession Number (Accession)

Use the appropriate filters to manage the query then press **Query**.

A list of matching exams will be displayed.

Import from US media or CD/DVD

1. Press the **Q/R** button to initiate an exam query.
2. Click on the **Import from Media** button
3. A browser window appears
4. Select the location of data to be imported



NOTE

You may select a folder containing DICOM data, a specific DICOM file or a DICOMDIR file to import.

5. Click on **OK** to confirm

Performing a Retrieve

Automatic Retrieve

If configured, the system performs an automatic retrieve of the last acquired series for each of the selected modalities.

Manual Retrieve

After a query is performed, the system will return a list of matching exams.

Exams are displayed in a table with the following attributes:

- Patient Name
- Patient ID
- Date of Birth
- Modality
- Number of Images
- Date/Time

To see more information about a particular study, place the cursor over a study and a tool-tip box will appear with additional information.

Use the **SonicPad®** to choose exams from the query list.

A checkmark will appear next to selected exams.

If you would like to query again, choose the **New Query** button at the bottom of the menu.

Press the **Retrieve** button to retrieve the selected exams.



NOTE

These exams will be transferred to the Aixplorer® Mach 30 system. Exams containing large numbers of images or long ultrasound loops may take a long time. It is best to perform a query and retrieve operation prior to the start of an exam.

When the selected exams have been retrieved, **RETRIEVED** appears next to each line.

Opening pushed DICOM data

You may send DICOM data from a PACS or a DICOM modality to the Aixplorer® Mach 30.

The Q/R notification icon will be displayed to indicate data have been pushed on the Aixplorer® Mach 30

Click on the notification icon or press the **Q/R** button on the control panel to see the received exams.

Displaying and Navigating Retrieved Images

Double-click on the **SonicPad®** on an image to display it in full screen.

The retrieve image will be displayed in the right pane.

You can navigate through the retrieved images by using the buttons at the top of the pane:

- **Previous** will go to the previous image
- **Next** will advance to the next image.

You can also use the **SonicPad®** to navigate through the retrieved images.

The **full screen icon** will enlarge the retrieved image to the side of the full screen, temporarily hiding the live or frozen image from the current exam.

All system controls will operate as usual on the current live or frozen image.

System controls will not effect the retrieved image.

Exiting Query and Retrieve

To quit viewing retrieved images, press the **Q/R** button on the control panel.

Ending an Exam

Make sure all the images you need are saved.

After the exam is complete, end the exam as follows:

Press **End Exam** on the touch screen.

Continuing an Exam

You have the possibility to continue an exam that was ended.

1. Press **End Exam** to make sure there is no exam in progress
2. Press **Review**
3. From the Patient Directory, select the exam you want to continue
4. Press **Continue** on the touch screen

The system has re-opened the closed exam and is in B-mode. The thumbnails of the previous session(s) of the same exam are displayed on the right side.

The time limit to re-open an exam may be configured in the **System/Display** tab of the System Configuration.

Press **End Exam** to close the exam.

9 Customizing the System

Description of the System Configuration

Your system can be customized in several ways to make it more useful for your needs.

Presets designed specifically for the exams you perform can be created, and system settings can be changed to optimize your workflow.

System configuration allows you to configure the entire system, its applications, and additional options.

To access system configuration, touch **Syst.Config** on the touch screen while in any active imaging mode.

Any changes made to the system configuration are automatically saved, unless otherwise specified.

Touch **Exit** on the touch screen to exit system configuration.

The system configuration is divided in 7 tabs:

- System/Display
- Device Settings
- Administration
- Presets
- Measurements
- Online Services
- System Diagnostics

Refer to each section for detailed information.

System/Display

Description of the System/Display Tab

The System/Display tab is divided in 3 tabs:

- System
- Regional parameters
- Exam
- Customization

System

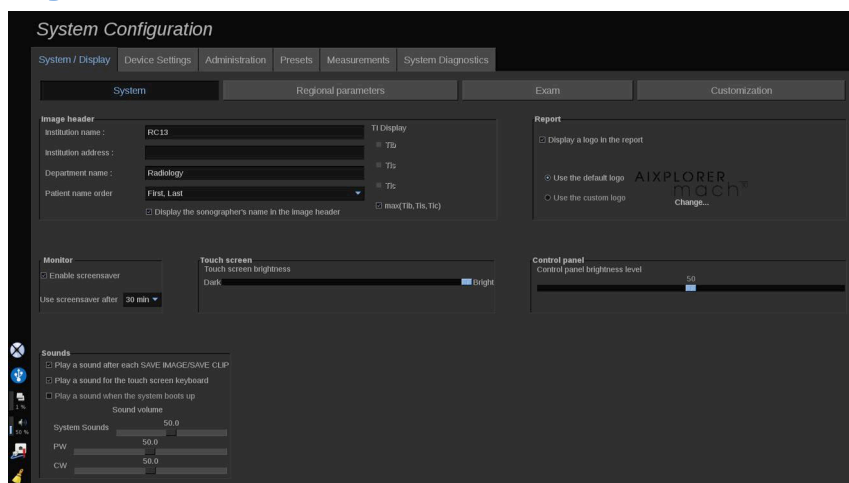

In this section, you can :

- Enter the institution name and address
- Choose the patient name order
- Display/not display the sonographer's name in the image header
- Select the Thermal Index (TI) to display on the imaging screen
- Upload from a USB media and insert a logo which will be displayed on the report header or choose the default logo to be displayed on the report header
- Adjust the audio volume of the system



NOTE

To change the logo to be displayed in the printed report:

1. Make sure the «Display logo in report» checkbox is checked

2. Do one of the following:

- Select «Use the default logo» if you want to use the Aixplorer® Mach 30 logo
- Select «Use the custom logo» if you want to use your own logo
 - Then plug a USB device with the logo you want to use into the system
 - Then click on the logo to browse for your own logo

- Enable/disable the screen saver, and configure it
- Calibrate the touch screen



NOTE

To calibrate the touch screen:

1. Press “touch screen calibration - calibrate now”
2. Press each calibration point that appears on the touch screen until it disappears

- Adjust the control panel brightness
- Adjust the touch screen brightness
- Activate a sound while for the following functions:
 - After each Save Image/Clip
 - For the touch screen Keyboard
 - When the system boots up
- Assign a function to the programmable key (configurable buttons on the control panel)
- Assign a function to each side of the foot switch (available as an option)

Regional parameters

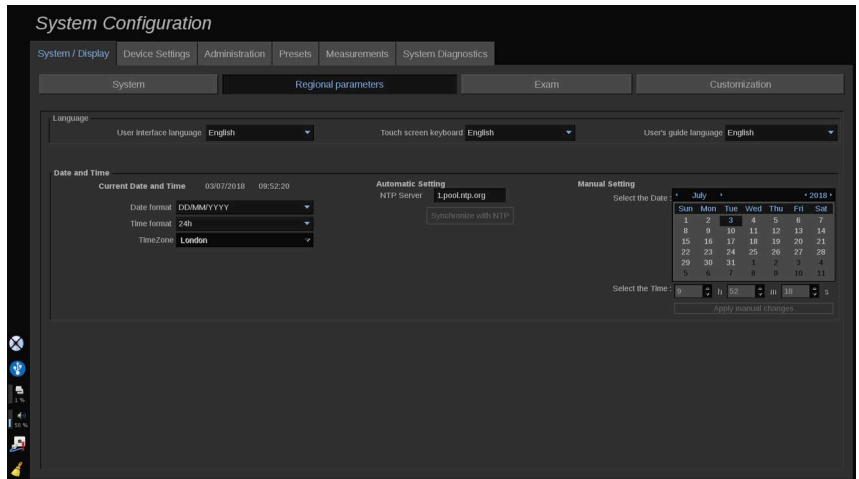

This section refers to the regional settings and language configuration of the system.

In this section, you can:

- change the system interface language
- set the keyboard language
- change the date and time format
- adjust the system's date and time.



NOTE

To set date and time:

1. Select a time zone from the drop down list
2. Do one of the following:
 - Enter a Network Time Protocol (NTP) server (by default, you can enter ntp.ubuntu.com), and click on “Synchronize with NTP” in the Automatic setting box
 - Pick a date and set the time in the Manual setting box, then click on “Apply manual changes”

Exam

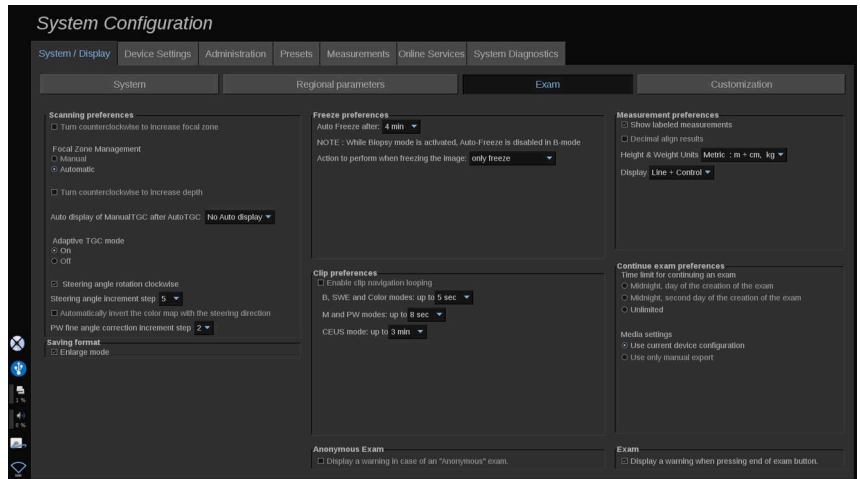

In this section, you can:

- Customize your scanning preferences:
 - Adjust some preferences for the Color and PW modes
 - Steering Angle Step defines the incremental step for the steering of the color box
 - PW Fine Angle Step defines the incremental step for the Fine Angle Correction in PW
 - Choose to automatically invert the color flow map with the steering direction
 - Customize the knob rotation direction for the steering angle, focal zone and depth
 - Configure the duration of the Manual TGC auto display on the touch screen after activating the Auto TGC. By default, the auto display is off.
- Customize some Freeze options:
 - Set time for the live mode's auto freeze
 - Choose the action to perform after freezing the image:
 - only freeze
 - display body markers
 - display annotations
 - display measurements

- Configure the limit duration of the prospective clip capture, for contrast mode and for the other modes.
- Customize the way the measurements are displayed
- Customize the Continue exam mode (see [the section called “Continuing an Exam” \[354\]](#))
- Choose to have a warning popup when saving an image for an anonymous patient
- Choose if you want the Focal Zone Management to be manual or automatic
- Choose to activate or deactivate the Adaptive TGC mode
- Choose to enable looping in clips
- Customize the rotation direction for the Depth and Focus knobs
- Choose to send enlarged images to a printer or USB device

Customization

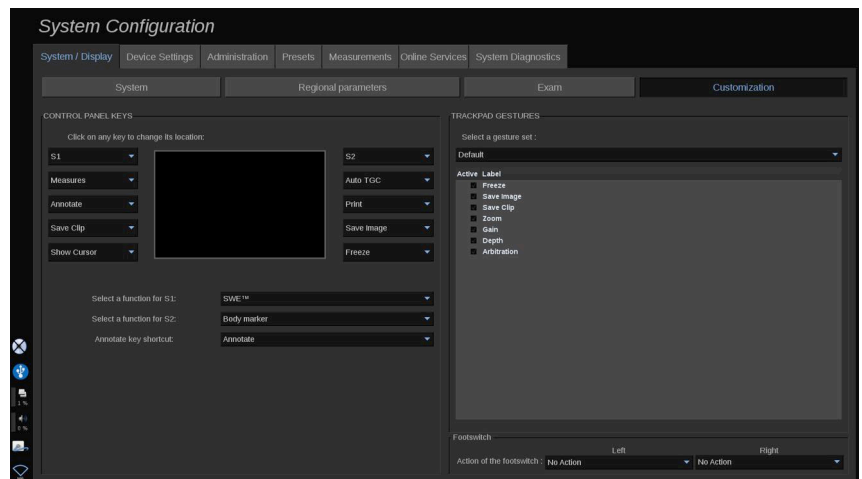

In this sub-tab, you can:

- Assign the control panel buttons to desired software functions
- Configure the SonicPad® gestures

Control Panel Keys

In this section you can assign software function position as desired.



NOTE

Please note that only the key position (located on both sides of the SonicPad®) can be changed.

Click on the labelled buttons (which are the currently assigned buttons) and change the associated software control as needed.



CAUTION

Please make sure that you also physically change the key position on the control panel. Please refer to [the section called “Customizable buttons” \[156\]](#) for more information about how to switch button location.

You can also assign a function to the S1 and S2 keys.

Click on the buttons and choose the desired function.

You can customize the shortcut to access **Body Markers** or **Annotation** when pressing **Annotate**.

Click on the dropdown list and choose whether you want to access to **Body Markers** or **Annotation** first when pressing **Annotate** on the control panel.

SonicPad® Gestures

You can activate or deactivate gesture control according to your needs. To do so, check or uncheck the checkboxes.

Footswitch

In this section you can assign software functions to both footswitch pedals.

Click on the drop-down lists to assign desired function to the left or right pedal.

Device Settings

Description of the Device Settings Tab

The Device Settings tab is divided in 3 tabs:

- Media settings
- Media association
- System DICOM options

Media Settings

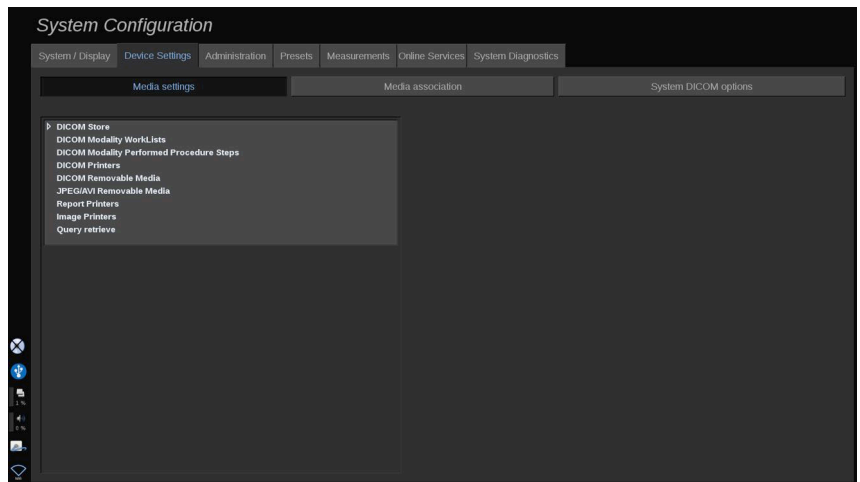

In this section, you can configure all the media already added and associated.

Click on Media Settings to see the list of active devices.

For DICOM Stores devices, a menu allows you to define the method to send the data :

- Send after acquisition
- Send on end exam
- Send manually

You can also define printing parameters for DICOM printers, Reports Printers, and Image printers, as well as JPEG/AVI Removable Media Export parameters (Compression level, export LUTs (Look Up Tables),...)

A dedicated "WorkList Settings" menu is available for the DICOM Modality Worklist servers. You can set the way of querying the Modality Worklist SCP:

- By Modality
- By AE Title
- By Date

and set the maximum responses you want to receive from the Modality Worklist server(s) when this device is available and configured in the Administration part.

Media Association

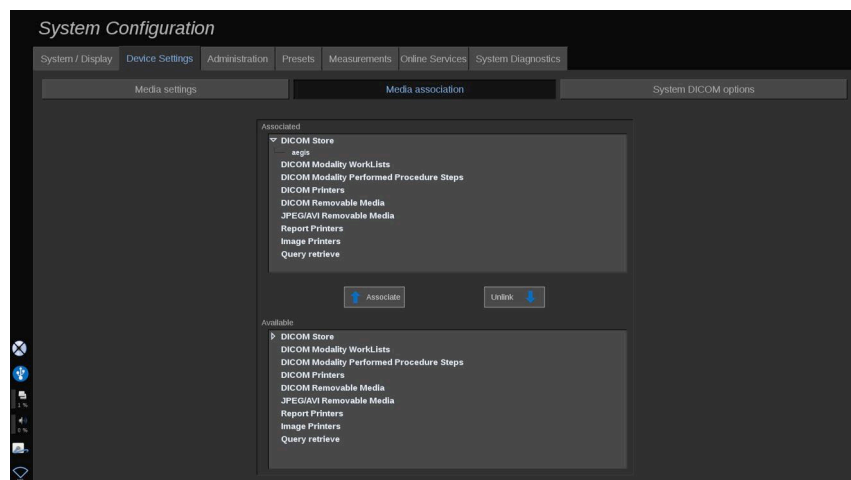

In this section, you can associate any media added in the tab Administration.

This section allows you to add an active device to the working configuration.

You can choose from the device list which has been pre-configured in the Administration part of the System Configuration.

To associate a device:

1. Navigate to the bottom of the screen where you will find the “available devices” list.
2. Click on the type of device, a list will be displayed.
3. Select the specific device you would like to associate.
4. Click on “associate”. The device will appear at the top of the screen in the “associated devices” list.



NOTE

You can associate one or several DICOM WorkList Servers, to be able to query several WorkList servers at the same time.

You can remove a device from the associate list by selecting it and click on the ‘unlink’ button.

System DICOM options

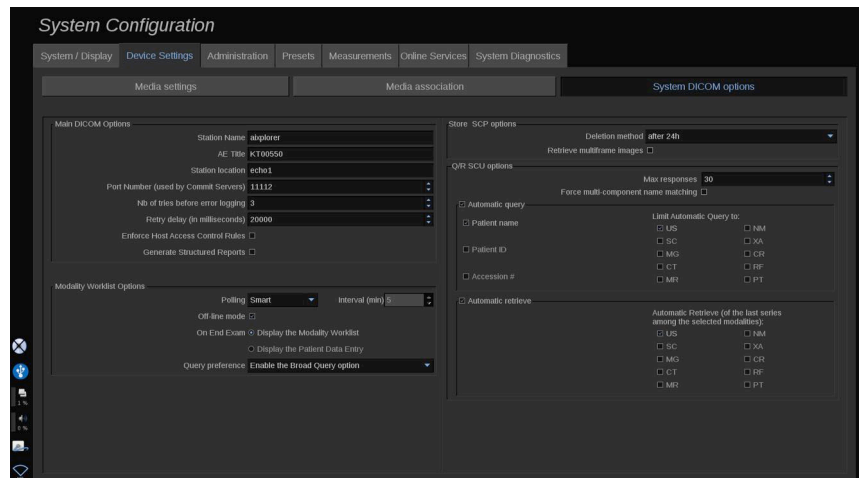

In this section, you can adjust the DICOM parameters.

In the Main DICOM Options part, you can enter all the DICOM parameters that identify the ultrasound system on a DICOM network.

You can also configure the system so that it will not communicate with unknown hosts, and choose if you want the system to generate Structured Reports or not.

In the Modality Worklist Options part, you can configure the way the Modality Worklist is refreshed with the “polling option”:

- Choose “Manual” to refresh the Worklist only manually
- Choose “Automatic” to set up a time to automatically refresh the Worklist
- Choose “Smart” to automatically refresh the Worklist each time you press End Exam on the control panel.

You can also choose to use the Off-line mode, so that when the network is disconnected, you still have access to the last refresh of the Worklist, by default this mode is on.

You can also set your workflow preference for the end of the exam:

- Display the Modality Worklist
- Display the Patient Data Entry

Finally, you can select the way of querying the Worklist when pressing End Exam in the "Query preference" drop-down list:

- Enable the Broad Query option
- Enable the Patient Query option
- Maintain the last selected option

In the Store SCP Options part, you can choose the deletion method and if you want to retrieve the multiframe images.

In the Q/R SCU options part, you can configure the Query/Retrieve parameters.

You can also configure the automatic query and automatic retrieve by selecting the queried fields and modalities.

Administration

Description of the Administration Tab

The Administration tab is divided in 6 tabs:

- Devices
- Ethernet configuration
- Wifi Configuration
- Network tools
- Disk maintenance
- Medical Staff



CAUTION

Image compression may result in the loss of image information.

While low levels of image compression are generally acceptable in medical imaging, using high levels of lossy compression may result in image degradation.

It is the responsibility of the user to set and maintain the degree of image compression which is diagnostically acceptable in exported images.

If you are uncertain as to what degree of compression is acceptable, consult the literature, or use the system default compression.

Devices

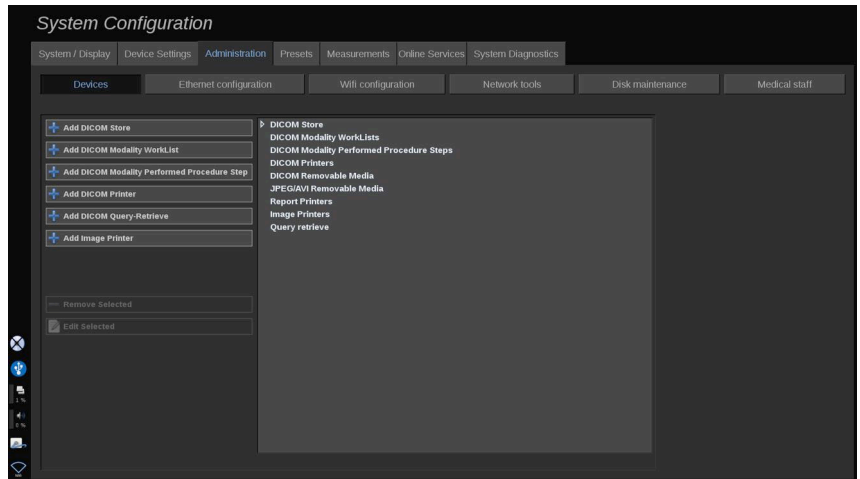

Devices refers to the initial devices configuration.

A list of device types that can be added is displayed on the left side of the screen, according to the options purchased:

- Add DICOM Store1
- Add DICOM Modality Worklist1
- Add DICOM Modality Performed Procedure Step (MPPS)1
- Add DICOM Printer1
- Add DICOM Query/Retrieve1
- Add image Printer



NOTE

Use the recommended driver for the selected printer.

Click on the appropriate button on the left to add a device and configure its parameters.

Click on a device in the middle of the screen to view and configure its parameters.



NOTE

When adding any DICOM device using the DICOM network connection, the following Basic Options must be fulfilled :

- Station Name, IP Address, Port Number and Application Entity Title (AET)

Configure a DICOM Store

To edit an existing DICOM Store device, select it on the devices list then click on **Edit Selected**.

On the **Basic Options** tab you can configure your DICOM device.

On the **Advanced Options** tab you can manage your exportation settings.

1. In the General Export Settings you can choose:

- if you want the patient's name to be shown or hidden on the exported files
- the types of data you want to enable for exportation (single or multi frames, PDF reports, DICOM SR)
- the Look Up Table (LUT) you want to apply on the exported images/video clips
- the type of character encoding

2. In the Pictures and Clips Settings you can define:

- the transfer syntax with pre-set image compressions
- the compression quality of the images
- the support of Color or Monochrome modes at the exportation
- the level of image size reduction
- the duration of the retrospective clip



NOTE

You can configure all these options the same way for any DICOM Removable Media.

In the **Commit Option** tab you can choose to ask for a commitment from the storage service.

When all the desired options have been set, press **OK** to save the changes.



NOTE

The nine available LUTs are pre-set filters acting on specific Brightness and Contrast settings of the exported images and/or clips.

They are used to make the images appear on a DICOM Review workstation Monitor as they appear on the Aixplorer® Mach 30 Monitor.



CAUTION

Applying a too bright or too contrasted LUT can have outcomes on the quality of the images informations.

It is the user's responsibility to carefully adjust all imaging parameters to avoid image saturation and obtain optimal quantitative time-intensity data.

Configure a DICOM Printer

To edit an existing DICOM Printer, select it on the devices list then click on **Edit Selected**.

On the **Basic Options** tab you can configure your DICOM Printer.

On the **Advanced Options** tab you can manage your printing settings :

- adjust the brightness and contrast
- choose the media type you will print on

- define the priority, the destination and the magnification type
- define the color and density of the borders and empty spaces of the document
- precise the session label, the configuration information and the smoothing type
- define the reduction percentage of document

When all the desired options have been set, press **OK** to save the changes.

Ethernet Configuration

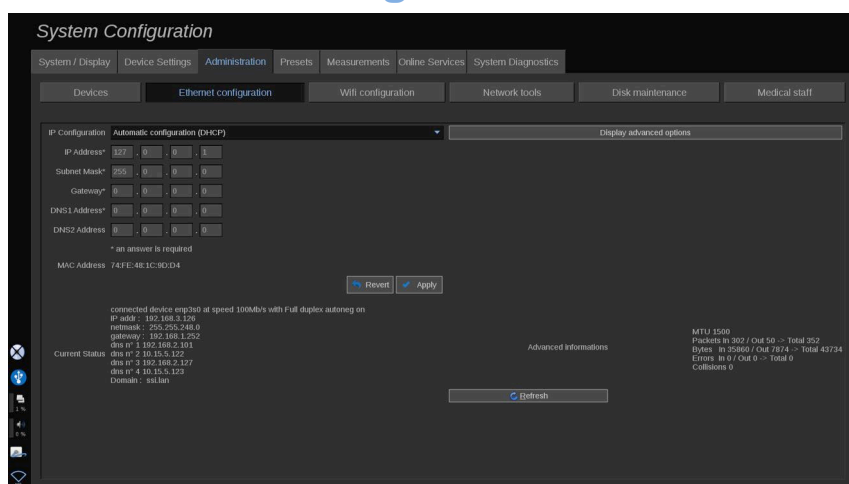

This section concerns the network configuration of Aixplorer® Mach 30.

The system shall be connected to the network through an ethernet cable. The system can be configured with a specific IP address and network setting, with a cable connected or can be automatically configured in DHCP mode.

For any network configuration, the MAC address is displayed and once connected, the network status is also displayed (especially important for the DHCP configuration).



NOTE

The Aixplorer® Mach 30 network connection is only opened for DICOM and network printer service.

The system does not require a minimum data rate to perform on the network.

In case of network connection failure, the data can be exported using a DICOM removable media or the embedded printer.



CAUTION

Integrating the Aixplorer® Mach 30 to a network with other connected devices may result in unpredictable risks. Nevertheless, the restricted access to the system prevents the user from using an antivirus solution.

WIFI Configuration

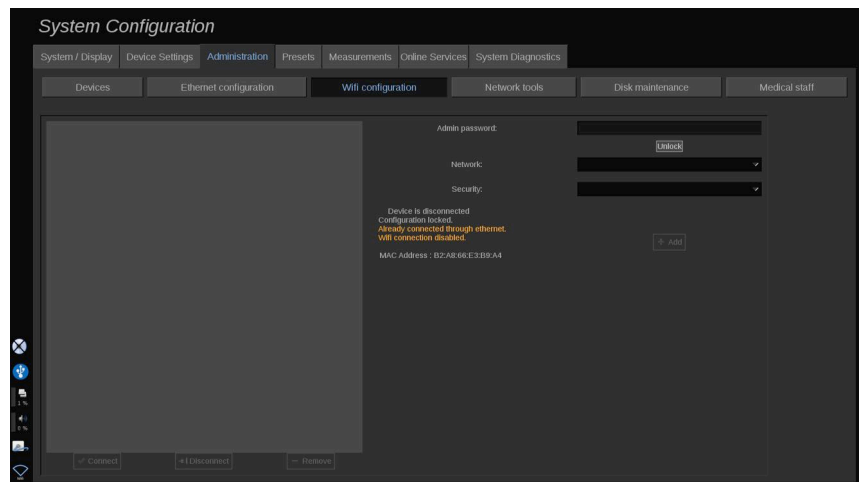

The Aixplorer® Mach 30 may be connected to the hospital WIFI network.

Check [the section called “Notification Icons” \[177\]](#) for a description of WIFI icons.



NOTE

The WIFI connection is not guaranteed in all geographies, and depends on the characteristics of the network.

The WIFI dongle is the Linksys AE3000, FCC/IC certified (FCC ID: Q87-AE3000).

Tests performed by external accredited lab are according to the following standards:

- RF measurements according to EN 300 328: WLAN 2.4GHz, IEEE Std. 802.11b/g/n
- MC measurements according to FCC part 15B
- European directive RED

Operating frequency range: 2412 ~ 2462MHz 5745 ~ 5825MHz (not active)

Configuration

The Aixplorer® Mach 30 may be connected to the hospital WIFI network.

1. Plug the WIFI dongle on the Aixplorer® Mach 30



CAUTION

Select a device whose temperature range is compatible with Aixplorer® Mach 30's use.

2. Open the **WIFI Configuration** sub-tab of the Administration tab
3. Enter your Admin password and click on Unlock
4. Select the appropriate network and security



NOTE

Only encrypted wireless networks are available (WPA with password).

You may connect to a hidden network. It will appear as **Hidden Network**. After selecting the hidden network, you will have to enter the SSID.

5. Enter the network password and click on **Add**.



CAUTION

Make sure to correctly configure the WIFI network before sending data.

Make sure the WIFI dongle is correctly plugged.

Make sure to correctly configure the WIFI network before sending data.
Make sure to connect your Aixplorer® Mach 30 to a secured wireless network



NOTE

The wired connection has the priority over the wireless connection.

It is therefore not possible to connect to a WIFI network if an Ethernet connection is detected. If a network cable is connected to the Aixplorer® Mach 30 and an Ethernet connection is detected while the Aixplorer® Mach 30 is connected to a WIFI network, the WIFI connection will be automatically deactivated.

You may also modify WIFI connection parameters or delete a WIFI network with the Admin password.

Please contact a SuperSonicImagine representative.

Connection

1. Select the appropriate WIFI network in the list
2. Click on **Connect**



NOTE

The selected WIFI connection will remain active as long as it is not deactivated (**Disconnect** button) or the system is not switched off.

Check [the section called “Notification Icons” \[177\]](#) for a description of WIFI icons.

Network Tools

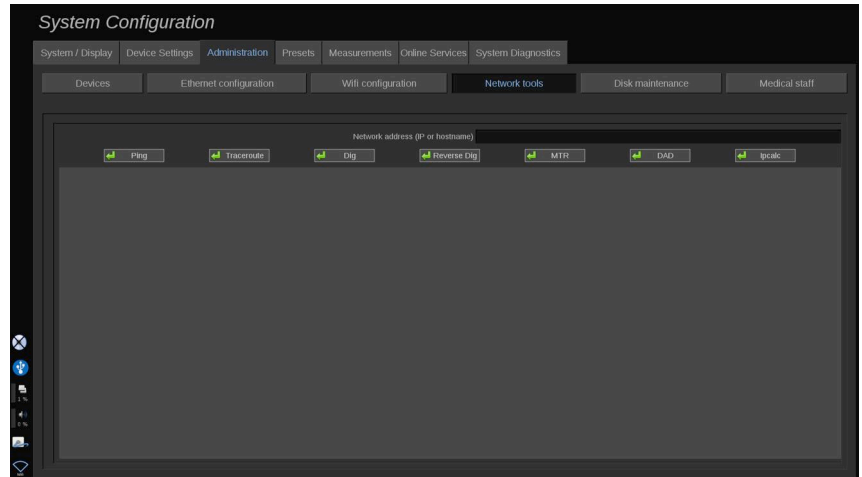

Once you have configured the network (see [the section called “Ethernet Configuration” \[372\]](#)), you have access to network tools:

- Ping
- Traceroute
- Dig and Reverse Dig
- MTR
- Duplicate address detection DAD
- Ipcalc

Contact your local SuperSonic Imagine Service Representative for further instructions on the use of these tools.

Disk Maintenance

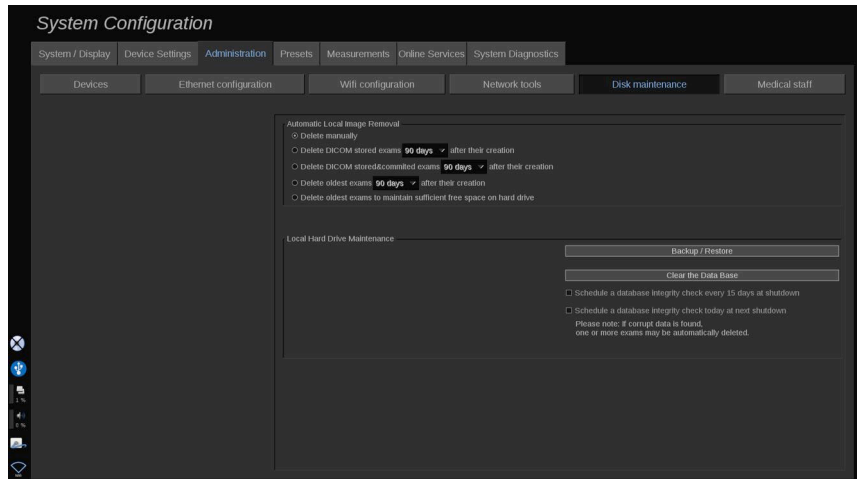

This section concerns all of the options to manage the studies contained on the system hard drive



CAUTION

The HDD should not be used as the primary source for long term storage. Exams should be backed up either to an external drive or via network on a regular basis.

If the system's HDD needs to be replaced or the system is upgraded, the HDD data will be erased and unrecoverable.

Automatic Local Image Removal

This section allows you to manage the way you want to purge your local exam database.

Delete manually is the default option, it allows you to delete manually any exam you want from the Patient Directory.



CAUTION

Make sure you delete exams from time to time to prevent the HDD to be full.

Delete DICOM stored exams requires your Aixplorer® Mach 30 to be connected to a PACS. You can configure the system to automatically delete exams already stored on your PACS, 24h, 2 days, 3 days, 5 days, 10 days, 30 days, 60 days or 90 days after their creation.

Delete DICOM stored & committed exams requires your Aixplorer® Mach 30 to be connected to a PACS. You can configure the system to automatically delete exams already stored and committed on your PACS, 24h, 2 days, 3 days, 5 days, 10 days, 30 days, 60 days or 90 days after their creation.

Delete oldest exams automatically deletes exams 24h, 2 days, 3 days, 5 days, 10 days, 30 days, 60 days or 90 days after their creation.

Delete oldest exams to maintain sufficient free space on hard drive automatically deletes oldest exams after the data storage reaches less than 20Go of free space. The system will delete exams until there is at least 50Go of free space.

Back up/Restore

You can also back up and restore some elements from your system.

BACK UP

1. Plug a USB device on which you want to back up some elements from your system
2. Press the **Backup/Restore** button
3. Enter the password
4. Press **OK**
5. Select your USB device
6. Select the elements you want to back up

7. Press **Start**



CAUTION

Make sure to back up data from time to time to prevent the HDD to be full. You can back up following the instructions above, or via DICOM.

RESTORE

1. Plug the USB device on which you backed up some elements of your system
2. Press the **Backup/Restore** button
3. Enter the password
4. Press **OK**
5. Select the USB device on which you backed up some elements of your system
6. Select the **Restore** tab
7. Select the back up file you want to restore on the left
8. Select the elements you want to restore on the right
9. Press **Start**

Medical Staff

The screenshot shows the 'System Configuration' window with the 'Medical staff' tab selected. The interface includes a navigation bar at the top with tabs for 'System / Display', 'Device Settings', 'Administration', 'Presets', 'Measurements', 'Online Services', and 'System Diagnostics'. Below this is a sub-menu with 'Devices', 'Ethernet configuration', 'Wifi configuration', 'Network tools', 'Disk maintenance', and 'Medical staff'. The main area contains several input fields for 'Last Name', 'First Name', 'Middle Name', 'Abbreviation', 'Name prefix', and 'Name suffix'. To the right, there is a 'DICOM ID Sequence' section with fields for 'Code value', 'Coding scheme designator', 'Coding scheme version', and 'Code meaning'. Below these fields are radio buttons for 'Performing physician / sonographer', 'Referring physician', and 'Requesting physician'. A note states: '*Last Name or First Name is required #Abbreviation of the performing physician / sonographer will be displayed during the exam and on the report'. At the bottom, there is a 'Name list' table with columns for 'Name' and 'Abbreviation', and buttons for 'New' and 'Remove'.

This section allows you to manage the list of physicians and sonographers that you can choose from in the Patient Data Entry.

In the list at the bottom of the screen, click on a name to display the related informations in the appropriate fields above the list.

To add a name:

1. Click on **New** on the right side of the list
2. Enter the appropriate data

The new name is automatically saved. They can be selected from the Patient Data form.

Presets

A Preset is a group of settings that optimizes the system for a specific type of exam. Presets establish many initial settings, such as gain value, color map, filter, TissueTuner™, Flow Optimizations, etc... When the system is turned on, the default Preset is active. Before beginning an exam, be sure that the appropriate Preset is active. You can choose from several default Presets. These default Presets cannot be deleted. Several Presets per transducer/application combination can be created and stored, depending on the number of buttons available on the individual transducer touch screen.

Description of the Presets Tab

The Presets tab is divided in 3 tabs:

- Annotations
- Bodymarkers
- Presets

It allows you to customize annotations and bodymarker packages, as well as imaging presets.

Annotation

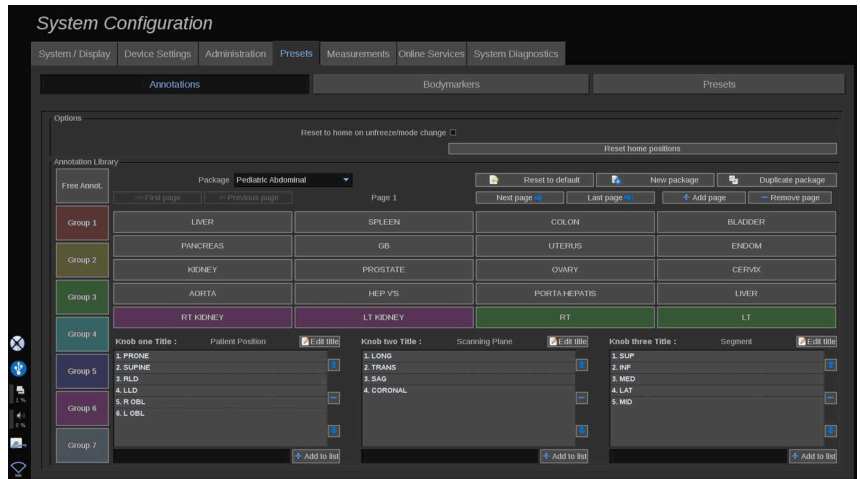

This section allows you to edit the annotation library for the current language. To edit the annotation library:

1. Select a package
2. Select the page you want to edit by using the navigation controls, located above the annotation grid:
 - First page/Last page
 - Previous page/Next page
 - Add page
 - Remove page
3. To create a new package, click on **New Package** and enter a name in the pop-up window.
4. To duplicate an existing package, click on **Duplicate Package** and enter a new name in the pop-up window. A new package will be created with all the annotations from the initial package without modifying it.
5. To change the name of an annotation, click on it and change it in the pop-up window
6. To create a new annotation on an empty button, click on the empty button and enter its name in the pop-up window
7. To remove an annotation from a group, select **Free Annot** (the first color box on the left side) and click on the annotation you want to remove from its group. The annotation button becomes “transparent” (no color) and will not be replaced by another one

8. To move an annotation from one group to another, click on the new group color you want to apply, and click on the annotation. The annotation will change color
9. To change a rotary knob label or create a new one, click on the **Edit Title** button located next to the knob you want to edit, and change it in the pop-up window
10. To delete a rotary knob value, click on the value and then click on the **-** button next to it
11. To add a rotary knob value, type the new value in the box and click on the **+ Add to the list** button next to it
12. To move a rotary knob value within the list, click on it and then click on the arrows next to it

Bodymarker

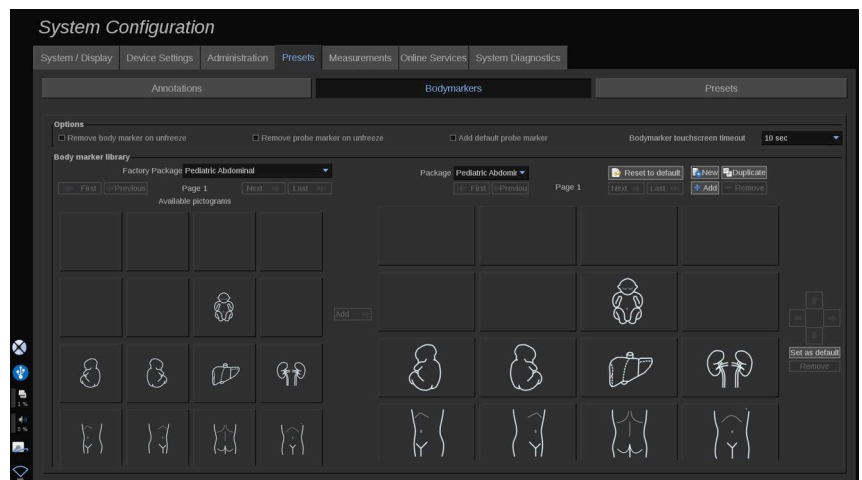

This section allows you to edit the body marker libraries and to customize some options related to body markers.

Options

You can choose to remove the body marker every time you unfreeze the image by checking the “Remove body marker on unfreeze” option.

You can choose to remove the probe marker from the body marker every time you unfreeze the image by checking the “Remove probe marker on unfreeze” option.

You can set up a time out for the body marker touch screen. At the end of this time out, the body marker touch screen will be automatically closed.

Body Marker Library

In this section, you can customize the body marker library for each preset.

TO VIEW THE BODY MARKER LIBRARY AVAILABLE FOR A GIVEN PRESET

1. Select the package you want to modify on the right part

You can navigate through the different pages of the library by using the following buttons:

- **First** displays the first page of the library
- **Previous** displays the previous page of the library
- **Next** displays the next page of the library
- **Last** displays the last page of the library

You can add and remove pages for the selected library by using the **Add** and **Remove** buttons.

TO REMOVE A BODY MARKER FROM THE PACKAGE

1. Click on the body marker you want to remove
2. Click on the **Remove** button below the arrow

TO MOVE A BODY MARKER ON THE PACKAGE PAGE

1. Click on the body marker you want to move

2. Click on the appropriate **arrow**

TO SET A GIVEN BODY MARKER AS DEFAULT FOR THE PACKAGE

1. Click on the body marker you want to set as the default body marker for the library
2. Click on **Set as default** below the arrows

The selected body marker will be displayed by default every time you press Body Marker on the control panel for the selected preset.

TO ADD A BODY MARKER TO A PACKAGE

All the available libraries on the system are displayed on the left part.

1. Select the appropriate package The available body markers are displayed below.
2. Click on the body marker you want to add to your library 3. Click on the **Add** button

The selected body marker will be added at the first available space in your library.

Note: all changes are automatically saved.

You can reset a body marker library for a given preset as it was by default by clicking on **Reset to default**.

TO CREATE A NEW BODY MARKER

1. Click on New and enter the name of the package in the pop-up window.
2. Choose bodymarkers in the library and add them to your package. Refer to [the section called “To add a body marker to a package” \[384\]](#)

TO DUPLICATE A PACKAGE

1. Click on **Duplicate** and enter a new name in the pop-up window.

A new package will be created with all the bodymarkers from the initial package without modifying it.

To add a bodymarker from another package, select the appropriate package and proceed as for adding a bodymarker.

Imaging Presets

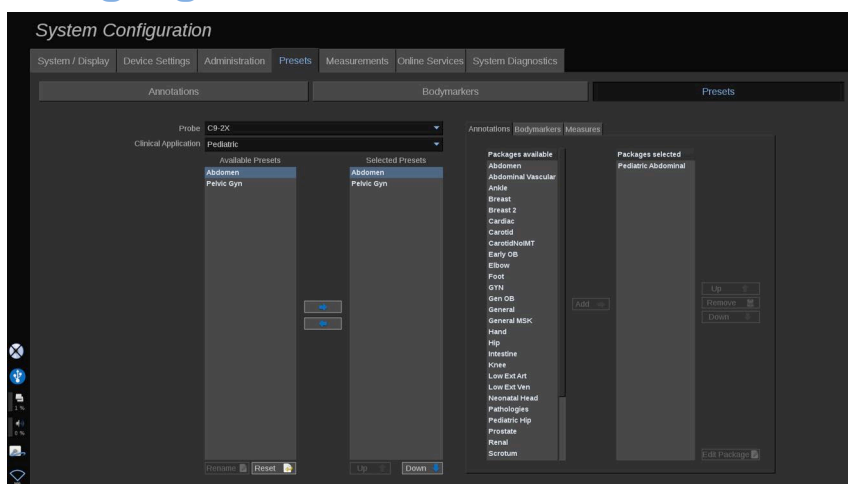

Creating a Preset

Once you have set the system to a desired configuration, you may want to make a Preset.

1. Press **Probe** on the control panel
2. Touch **New Preset**

A dialog box will appear on the main display.

3. Select the application in which you want to save the preset
4. Select an annotation library for your new preset
5. Select a body marker library for your new preset

6. Select a measurement library for your new preset
7. Using the keyboard, enter a name for your new Preset.
8. Select **OK**.
9. Press **Probe** on the control panel to verify your Preset.

The user-created presets appear in light blue on the touch screen. The factory presets appear in dark blue on the touch screen.

Managing Presets

In the Presets sub-tab, you can manage imaging presets.

1. Select the appropriate probe and application on the left side of the screen.

The available presets for this probe and this application will appear.

ADDING PRESETS

Selected Presets lists the presets as they will appear on the touch screen.

1. Click on the preset you want to add from the Available Presets list on the left
2. Click on the right arrow to add it to the Selected Presets list

REMOVING PRESETS

Selected Presets lists the presets as they will appear on the touch screen.

1. Click on the preset you want to remove from the Selected Presets list
2. Click on the left arrow to add it to remove it

CHANGING THE DISPLAY ORDER OF THE PRESETS ON THE TOUCH SCREEN

1. Select the preset that you want to modify in the Selected Presets list.
2. You can move a preset within the list with the Up and Down buttons.

They will be displayed in the same order on the touch screen preset page.



NOTE

To reset a factory preset to the default configuration, click on **Reset**.

MODIFYING THE ANNOTATION PACKAGE(S) OF A PRESET

1. Select the small **annotation** tab on the right side of the screen.

You will see the available packages box on the left of the Add button and the selected packages box on the right.

The selected packages are those already available in the preset.

2. To add an annotation package, select the appropriate package in the available packages box and click on **Add**.

It will appear in the selected packages box.

3. In the selected packages box you can remove a package by clicking on **Remove**.
4. You can also move a package within the list using the **Up** and **Down** buttons.
5. To edit the annotation package, select a package in the selected packages box and click on **Edit Package**.

MODIFYING THE BODY MARKER PACKAGE(S) OF A PRESET

1. Select the small bodymarker tab on the right side of the screen.

You will see the available packages box on the left of the Add button and the selected packages box on the right. The selected packages are those already available in the preset.

2. To add a bodymarker package, select the appropriate package in the available packages box and click on **Add**.

It will appear in the selected packages box.

3. In the selected packages box you can remove a package by clicking on **Remove**.
4. You can also move a package within the list using the **Up** and **Down** buttons.
5. To edit the bodymarker package, select a package in the selected packages box and click on **Edit Package**.

MODIFYING THE MEASUREMENT PACKAGE(S) OF A PRESET

1. Select the small **measurement** tab on the right side of the screen. You will see the available packages box on the left of the Add button and the selected packages box on the right.

The selected packages are those already available in the preset.

2. To add a measurement package, select the appropriate package in the available packages box and click on **Add**. It will appear in the selected packages box.
3. In the selected packages box you can remove a package by clicking on **Remove**.
4. You can also move a package within the list using the **Up** and **Down** buttons.
5. To edit the measurement package, select a package in the selected packages box and click on **Edit Package**.

Changing a Preset Name

1. Do one of the following:
 - Press **Probe** on the control panel, then touch **Manage Presets** on the touch screen
 - Touch **Syst. Config.** on the touch screen, then click on **Presets** and **Presets**
2. Choose the probe and the application

The list of user-defined Presets appears.

3. Click on the Preset you want to rename and click on **Rename**

A popup menu appears

4. Enter a new name
5. Click on **OK** to validate

Deleting a Preset

You can delete the Presets you created. The factory presets cannot be deleted.

1. Do one of the following:
 - Press **Probe** on the control panel, then touch **Manage Presets** on the touch screen
 - Touch **Syst. Config.** on the touch screen, then click on **Presets** and **Presets**

2. Choose the probe and the application

The list of user-defined Presets appears.

3. Click on the Preset you want to delete and click on **Remove**.

A popup menu appears.

4. Click on **OK** to validate

Measurements

Description of the Measurements Tab

The Measures tab is divided in 4 tabs:

- Measures
- Labels and Calculations
- Packages
- Obstetrics

Measures

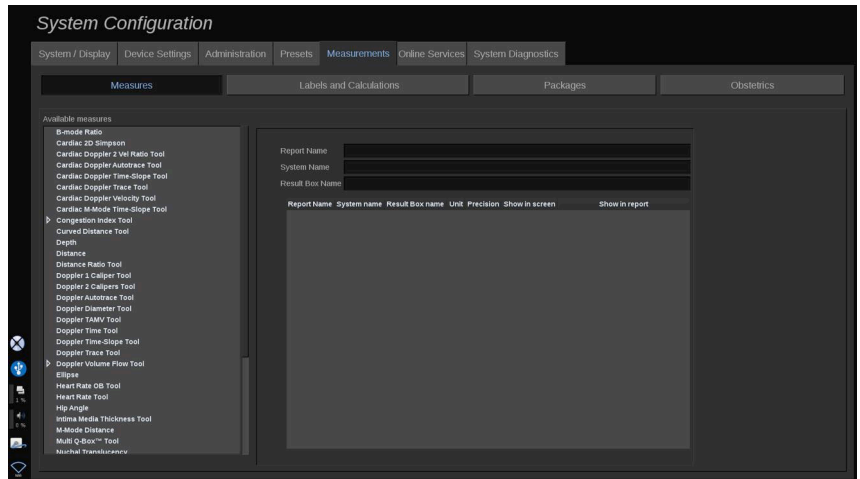

This section allows you to customize the measurement tools.

1. Select a measurement in the left list
2. You can modify the unit and the precision. Click on the unit or the precision you want to modify and select the appropriate unit in the drop down list.
3. Check the measurements that you want to be displayed on screen and/or included in the report.

Labels and Calculations

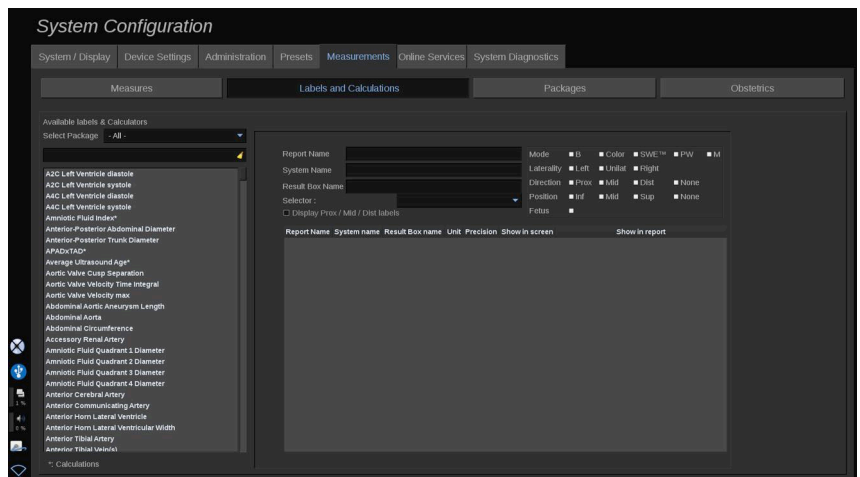

This section allows you to configure each labeled measurement individually.

1. Select the appropriate package
2. Select the labeled measurement you want to customize



NOTE

You may use the white area as a search box to easily find a labeled measurement in the list.

Click on the broom icon to erase the text in the search box.

The information and options related to this labeled measurement appear on the right.

3. You can modify the unit and the precision. Click on the unit or the precision you want to modify and select the appropriate unit in the drop down list
4. With the drop down, you can choose the measurements that you want to be displayed on screen and/or included in the report.



NOTE

For Internal Carotid Artery and Common Carotid Artery labeled measurements, you may uncheck the **Display Prox/Mid/Dist labels** checkbox to hide the segment labels. Only Internal Carotid Artery and Common Carotid Artery generic labels will appear in the labeled measurement list.

Packages

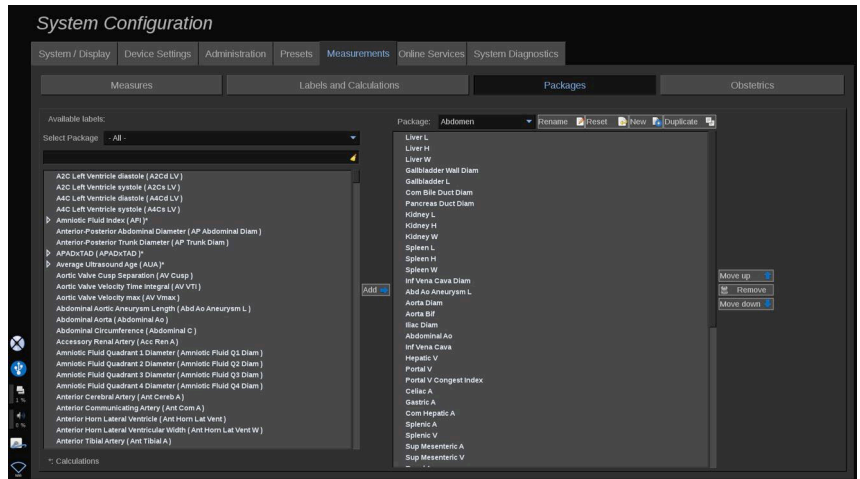

This section allows you to configure your own labeled measurements packages.

The left side box contains all the labels available on the system.

The right side box contains the labels available for the selected application, as it appears on the main display when you press **Meas.** on the control panel.

You can edit the labels that are available for a given application.

To add a labeled measurement to a package:

1. Select the package you want to modify on the right side of the screen
2. Select the package that contains your labeled measurement on the left side of the screen. You can select All to see the labeled measurements available on the system.
3. Select the labeled measurement you want to add from the left side list
4. Click on **Add**

To remove a labeled measurement from a package:

1. Select the package on the right side of the screen
2. Select the labeled measurement you want to delete from the right side list

3. Click on **Remove**

To move a labeled measurement within the list in a package:

1. Select the package
2. Select the labeled measurement you want to move from the right side list
3. Click on **Move up** or **Move down** until it reaches the desired place

To rename a package:

1. Select the package on the right side of the screen
2. Click on **Rename**
3. Enter a new name in the pop-up window

To reset a package to its default configuration:

1. Select the package on the right side of the screen
2. Click on **Reset**

To create a new package:

1. Click on **New**
2. Enter a name in the pop-up window and click on OK
3. You can then add labeled measurements to the new package. It will be available in the presets.

To duplicate a package:

1. Click on Duplicate
2. Enter a name in the pop-up window and click on OK

A new package will be created with all the labeled measurements.

Obstetrics

The Obstetrics section is divided in 3 parts:

- GA - EFW (Gestational Age - Estimated Fetal Weight)

- Fetal Growth and EFW Percentiles
- Tables and Equations



CAUTION

Be careful to confirm the patient name and ID before starting an examination for a new patient.

Check the date format before entering date of birth, Last Menstrual Period (LMP), Estimated Date of Delivery (EDD), Date Of Conception (DOC) and Ovulation Date. Incorrect entry of these parameters will result in an incorrect Gestational Age (GA).

Enter the EDD and GA in the patient's medical record for backup.

Check the "Activate OB calcs" button on the Patient Data Entry page (PDE) in order to perform obstetric calculations.

It is necessary to specify which OB author is to be used for each particular measurement to calculate the GA and get an Estimated Fetal Weight (EFW).

A diagnosis can not be only based on one measurement or data. Be careful to always consider the overall clinical evaluation of the patient, including the medical record.

Depending on fetal position, some measurements may be incorrect. Be careful to always consider the overall clinical evaluation of the patient, including the medical record.

The system provides fetal measurements for up to five fetuses. Be careful not to confuse the fetuses during measurements.

For each measurement performed, you can select either the first, last, average, minimum, maximum or specifically one of the five measurements that are allowed to be displayed, using the selector feature in the Measurements tab of the Report. Be careful when deleting measurements, as this will affect the selector result.

Deviations from the normal values of measurements must be judged based on the graphs and literature.

GA- EFW

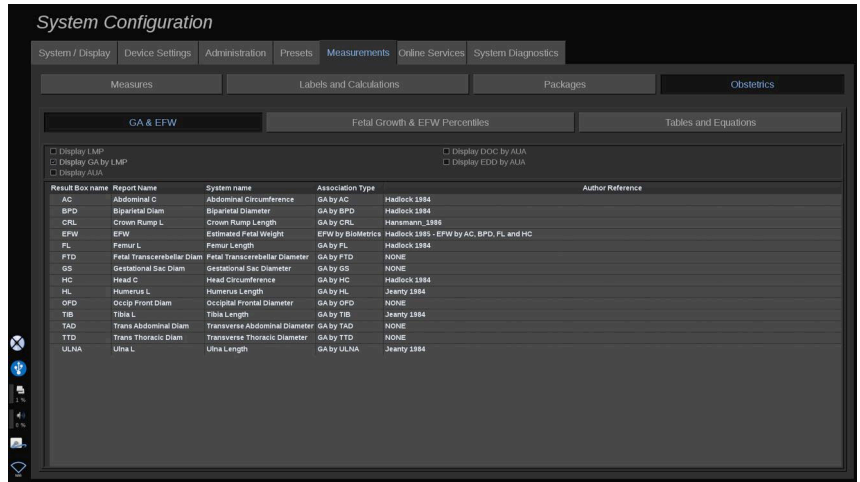

This section allows you to customize the information you want to display on screen:

- LMP (Last Menstrual Period)
- GA by LMP
- AUA (Average Ultrasound Age)
- DOC (Date of Conception) by AUA
- EDD (Estimated Delivery date) by AUA

In this section, you can also specify the table you want to use for each OB calculation.

For each OB calculation (whose name is displayed in the **Result Box name** column), the type of calculation is described in the **Association Type** column.

1. Click on the **Author reference** name to select another author.

Fetal Growth & EFW Percentiles

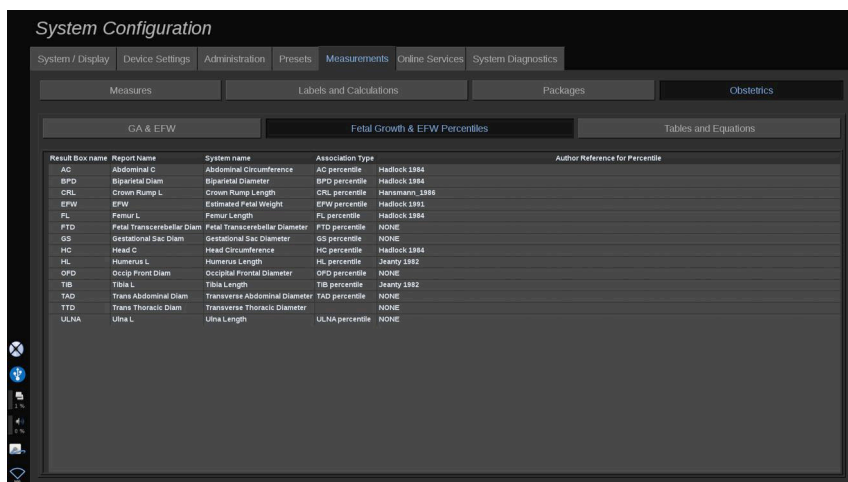

In this tab, you can select which table to use for the fetal growth and EFW percentiles.

1. Click on the author/date in order to change it
2. Select the new author/date on the list

Tables and Equations

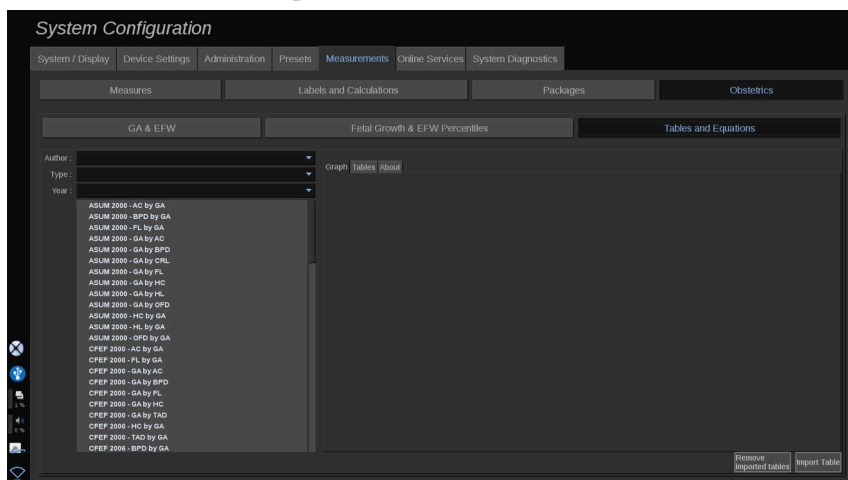

In this section, you can visualize the reference tables for OB as tables or graphs.

1. Select the Author, Type and Year of publication
2. In the right part, click on Graph to visualize the graph, Table to visualize the table and About to visualize the document references.

IMPORTING TABLES

You have the capability to import tables that have been created for Aixplorer® Mach 30.

1. Plug a USB device on a computer
2. On this USB device, create a folder called **ObTables** (case sensitive)
3. Copy the table(s) provided by SuperSonic Imagine in the created **ObTables folder**



CAUTION

Do not rename the file provided by SuperSonic Imagine.

4. Correctly disconnect the USB device from your computer
5. Plug the USB device on Aixplorer® Mach 30
6. Open the **System Configuration** menu
7. Click on the **Measurements** tab
8. Click on the Obstetrics sub-tab and then the **Tables and Equations** section
9. Click on **Import Table** at the bottom right of the screen

The following pop-up window is displayed:

10. Click on the arrow to select your USB device from the list
11. If tables are correct on the USB device, a green checkmark will be displayed



NOTE

If one or several tables are displayed with a red dot, the system did not recognize them.

The Import Tables button will be grayed out.

- a. Plug your USB device on your computer
- b. Delete all tables from your USB device
- c. Copy correct tables on your USB device and restart the above procedure.

12. Click on **Import Table** on the pop-up window

13. Configure the imported tables as needed



NOTE

A re-installation of the same software version would remove all imported tables.

DELETING IMPORTED TABLES

It is possible to delete all imported tables from Aixplorer® Mach 30.

1. Open the **System Configuration** menu
2. Click on the **Measurements** tab
3. Click on the **Obstetrics** sub-tab and then the **Tables and Equations** section
4. Click on the **Delete all imported tables** button at the bottom right of the screen

Online Services

The Online Services feature allows you to remotely update your Aixplorer® Mach 30 system with software update and/or options. You can also allow the SuperSonic Imagine service to perform remote maintenance on your system, or allow your system to send diagnostics and status information.

The Online Services tab is divided in 3 sub-tabs:

- Online System Update
- Online Maintenance/Diagnostics
- Online Servers Configuration

IMPORTANT

When in the Online Services tab, you have to log in with your Admin password to access further content.

If you are not logged in, you can still view the configuration of the tabs but you are not allowed to change or modify settings.

To log in, do as follows:

1. Enter your Admin password
2. Click on **Unlock**

You are now identified as an Online Services Administrator

3. Check the **Activate Online Services** checkbox
4. The first time you enable Online Services, a License Agreement pop-up is displayed

If you agree to the license, press **Agree**

You now have access to the full content of Online Services.

Please note that you will be automatically logged out every time you exit the System Configuration.

Online System Update

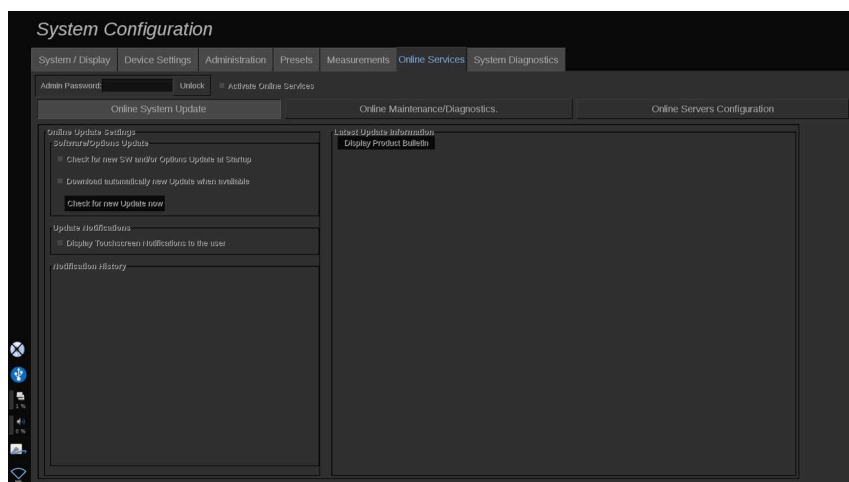

In this sub-tab you can manage several settings related to software update and option.

Online Update Settings

The **Software/Options Update** section allows you to:

1. Choose for a check to be performed at every start up if there are new updates available (software update, set of options, or both).

To do so, **check** the dedicated checkbox.



NOTE

Please note that the checkbox is checked by default for your convenience.

2. Choose to download automatically a new software update, a set of options or both when available.

To do so, **check** the dedicated checkbox.

3. Check for new updates whenever you want.

Click on **Check for new update now** to search manually for new updates.

The **Update Notifications** section allows you to enable or disable the following notification icon located on the touch screen.

This icon notifies you when new updates are available. To activate or deactivate the notification alert, **check** or **uncheck** the checkbox.



NOTE

Please note that the checkbox is checked by default for your convenience.

The **Notification History** section keep track of all the notifications related to recent updates.

Latest Update Information

This section allows you to view a Product Bulletin which gives a description of the latest software update installed on your system.

To view or hide the document, click on **Display Product Bulletin** or **Hide Product Bulletin**.



NOTE

Installed options can be seen in the System Diagnostics tab.

Online Maintenance/Diagnostics

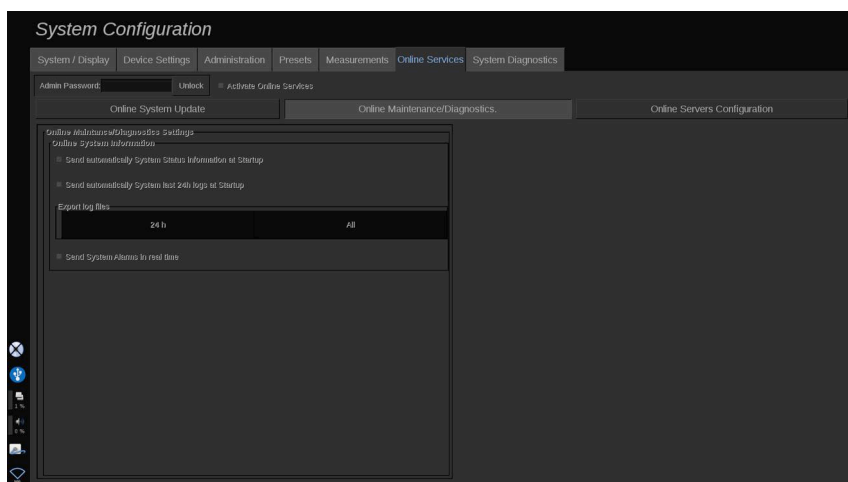

In this sub-tab you can manage settings regarding the maintenance and/or diagnostics of your Aixplorer® Mach 30 system.

The **Online System Information** section allows you to:

1. Automatically send system status information at every startup. This allows SuperSonic Imagine to monitor your system status.

To do so, **check** the dedicated checkbox.

You can also manually send system status information whenever you want by clicking on **Send System Status now**.

2. Automatically send last 24 hours logs at every startup.

To do so, **check** the dedicated checkbox.



NOTE

Please note that this checkbox is unchecked by default for your convenience. As logs are heavy files, this could slow down your system.

You can also manually send last 24 hours logs whenever you want by clicking on **Send last 24h logs now**.

3. Send system alarms in real time. To activate this setting **check** the dedicated checkbox.

Activating this feature will automatically send reports of any possible system errors you could encounter while using the system.

Through the **On-demand Service Connection** section you can give the permission to SuperSonic Imagine Service to connect to your system for remote maintenance or diagnostics purpose.

To do so, click on **Start Service Connection**.

You can also set the duration after which the connection will be stopped if there is not activity from SuperSonic Imagine Service.

Please refer to the next section to see how to configure the connection to SuperSonic Imagine servers.

Online Servers Configuration

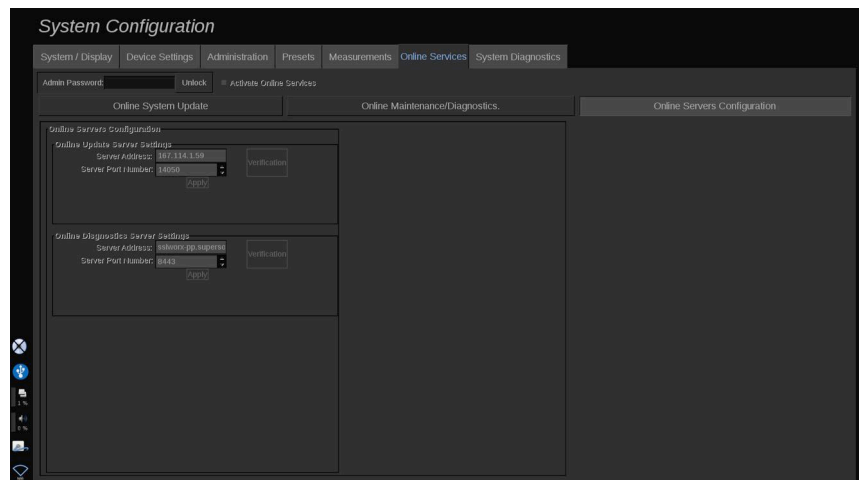

In this sub-tab you can configure the SuperSonic Imagine servers to which your system will be connected when using Online Services.

IMPORTANT

Your Aixplorer® Mach 30 must be open to external network connection for Online Services to be effective.

In the **Online Update Server Settings** section, you can configure the server address as well as the server port number you will be connected to for any software or option update purpose.

In the **Online Diagnostics Server Settings** section, you can configure the server address as well as the server port number you will be connected to for any remote maintenance or diagnostics purpose.



NOTE

All the fields are already pre-filled for your convenience.

If the server addresses change, the new ones will be provided to the referring administrator.

Both servers addresses and port can be verified at any moment. To do so, click on **Verification**

In case of failure, click on **Details** for more information on the connection failure. And if needed, contact your SuperSonic Imagine representative.

How to update software versions and options

When new updates and/or sets of options are available, the notification icon located on the touch screen will inform you.

1. Press this icon

A pop-up describing the new software updates/options available is now displayed

2. Go to the System Configuration, Online Services tab and log in

3. Click on **Check for new update**



NOTE

If you chose for the system to download updates automatically, the button **Install new Update now** will be displayed by default since the updates/options will have been downloaded beforehand and ready to be installed.

A pop-up is displayed

4. Click on **Yes** to download the software update/options

The pop-up closes

Wait for the download to be done by checking the download icon on the left of the screen

5. Click on **Install new Update now**

A new-pop up is displayed

6. Click on **Install** to initiate the installation



CAUTION

Please note that you won't be available to scan during the installation process.



WARNING

Do not power off or unplug your system until the process is complete.

A self test will now start to check if the system is ready to install the update.

After the self test is done, wait for the update process to start.

When the software update and/or options are installed, the system will automatically restart.

System Diagnostics

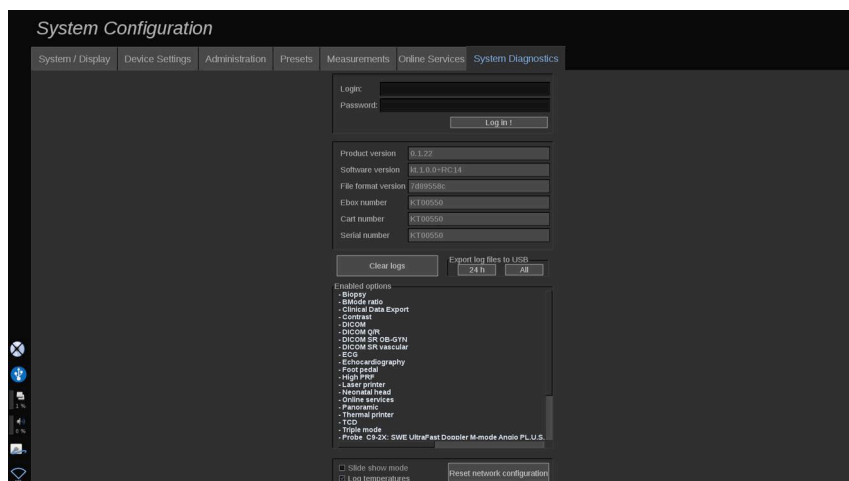

The Diagnostic tab is intended to be accessed by service personnel only.

Password access to the some of the contents is required to perform system diagnostic tests.

This section is only for field service engineers.

A password is not required to access some basic system information, as follows:

- Product version
- Software version
- File format version
- Cart number
- Serial number
- Panel firmware
- List of enabled options

In addition, 3 buttons are available:

- Reset Panel
- Clear logs
- Export logs to USB

In this tab you also have access to the remote service.

The Super Sonic Imagine Remote Service Solution enables the monitoring of the Aixplorer® Mach 30 Ultrasound System.

Two ways are defined to communicate with Aixplorer® Mach 30:

- the user of the Remote Service web interface communicates in real-time with the system
- both tasks to perform and results are pushed on the remote server by the User of the Remote Service web interface and Aixplorer® Mach 30 when connected.

A manual system logs upload on the Remote Service website allows a third way to recover data from the system.



NOTE

You can refer to the Remote Service Solution User's Guide for further informations.

10 System Care & Maintenance

Changing Printer Paper and Toner





Refer to the user's manual of your specific printer for guidance on how to properly change printer paper and toner.

Cleaning the System

Cleaning Frequency

You can perform the maintenance operations as described in this chapter. Cleaning of the Aixplorer® Mach 30 ultrasound system should occur at regular intervals, or more frequently as needed.

SuperSonic Imagine provides the following recommended cleaning intervals as guidelines:

	Part	Recommended Cleaning Frequency
	System Display Monitor	Weekly, or as needed
	System Control Panel	Daily, or between patients
	Touchscreen Display	Daily, or between patients
	System Exterior: chassis and Handles	Weekly, or as needed
	Air Filter	Clean monthly

Part		Recommended Cleaning Frequency
	Transducers: cleaning and disinfection	Between patients

It is prudent to continually survey the system for maintenance needs. Contact your SuperSonic Imagine Sales or Service authorized representative for further details.



CAUTION

If you have any questions regarding basic maintenance, or prefer to have maintenance service performed, contact your authorized SuperSonic Imagine Service representative.

Always press the On/Off switch, turn off the power switch at the back of the machine, and disconnect the system from the wall outlet before performing maintenance or cleaning the system.

It is recommended that gloves and protective eyewear are used when cleaning the system.

Do not spray any cleaning agents directly onto the system. They may leak into the system, damaging the system and voiding the warranty.

Do not allow standing liquid to collect around the control panel keys.

Do not allow liquid to drip inside the system chassis.

Cleaning the Exterior of the Machine

The exterior of the system should be periodically cleaned with a soft cloth, lightly moistened with water and a gentle soap. This includes the system chassis, control panel and handles. Be sure to clean any unused gel from the surface of the control panel after system use.

The products below have been tested and found to be compatible with SuperSonic Imagine Aixplorer® Mach 30.

Solution	Manufacturer	Cleaner/ Disinfectant	Active ingredient
Sani-Cloth Active	PDI	Cleaner Disinfectant	Quat. Ammonia
Sani-Cloth Af3	PDI	Cleaner Disinfectant	Quat. Ammonia

Cleaning the Monitor

A clean, soft cotton cloth dampened with an ammonia-based window cleaner should be used to clean the Monitor display. Do not use paper towels, as these may scratch the display monitor. The cleaning agent should be sprayed onto the cloth, not directly onto the display surface. Take care not to get any cleaning agent into the housing of the system. This may lead to system damage.

Cleaning the Touch Screen Display

A clean, soft cotton cloth dampened with an ammonia-based window cleaner should be used to clean the Touch Screen display. Do not use paper towels, as these may scratch the display monitor. The cleaning agent should be sprayed onto the cloth, not directly onto the display surface. Take care not to get any cleaning agent into the housing of the system. This may lead to system damage.

Cleaning the Air Filter

The Aixplorer® Mach 30 ultrasound system is equipped with an air filter. It should be inspected every month and cleaned as needed. At first switch on of the system after the first day of the month, the system displays an

icon as a reminder to check the air filter. Please refer to the following air filter cleaning procedure, and click **OK** on the pop-up window.

The air filter is located below the system on the left side.

To remove it, pull it towards you using the handle. It is recommended that the air filter be cleaned monthly or more frequently if a significant accumulation of dust or debris is noted.

The air filter may be removed, cleaned with slightly compressed air, vacuumed, and/or rinsed with clean water. Allow the filter to air dry before re-installing in the system. Spare the air filter is provided for immediate use. Additional air filters can be ordered from SuperSonic Imagine Customer Service.

To Maintain the Air Filter

1. Remove the air filter by pulling the handle towards you
2. Inspect the filter, and if it is dirty, clean it following the cleaning instructions

If it the air filter is damaged, replace it with a spare

3. Depending on the condition of the air filter, use either a vacuum cleaner or water to clean the dirty filter
4. Thoroughly dry the cleaned filter before re-installing



WARNING

Before performing maintenance or cleaning, always press the On/Off switch, turn off the power switch at the back of the machine, and then disconnect the system from the wall outlet.

Increased internal temperature can be caused by dirty air filter.

Failure to keep the air filter clean can result in the system becoming unavailable during critical use.

Never install an air filter that is not completely dry.



CAUTION

Turn off power before you remove the air filter.

Do not turn power on without the air filter installed.

Cleaning and Disinfecting the Barcode Scanner

Maintenance

Cleaning the Scanning Window

Reading performance may degrade if the scanner's window is not clean. If the window is visibly dirty, or if the scanner isn't operating well, clean the window with a soft cloth or lens tissue dampened with water (or a mild detergent - water solution). If a detergent solution is used, rinse with a clean lens tissue dampened with water only.

Cleaning the Scanning Housing

The HS-1M is IP54 rated when the cable is attached. This means that liquids and dusts will not penetrate into the housing. However, the scanner should not be submerged in water or other liquids. It is also good practice to dampen the cleansing cloth vs. spraying the scanner directly.

The HS-1M housing is compatible with the following medical grade cleaners:

- Sani-Cloth® HB
- Sani-Cloth® Plus
- Hydrogen Peroxide
- CaviWipes™
- 409® Glass and Surface Cleaner
- Windex® Blue
- Clorox® Bleach (100%)

- Isopropyl Alcohol
- Gentle dish soap and water



CAUTION

Do not submerge the HS-1M in water.

Do not use abrasive wipes or tissues on the HS-1M's window - abrasive wipes may scratch the window.

Never use solvents (e.g., acetone, benzene, ether, or phenol-based agents) on the housing or window - solvents may damage the finish or the window.

Cleaning and Disinfecting the ECG Module

ECG leads cleaning instructions

- Don't link the leadwire with monitor when cleaning or listerize
- Cleaning or disinfecting before use for new patient
- Available 70% isopropyl alcohol or alcohol solution can be used cleaning the surface of ECG electrode
- When cleaning, please prepare a clean, dry cushions dip in on clean fluid. And use the foam-rubber cushion wipe all the surface electrode cushions and cable. Then use another clean, dry cushions dip sterile or distilled water. And use the foam-rubber cushion to wipe all the surface electrode cushions and cable. At last, use the foam-rubber cushion wipe all the surface electrode cushions and cable.



CAUTION

The connector plug needle may not touch the cleansing liquid, otherwise you will to a blood oxygen instrument, human body damaged.

ECG end cleaning instructions

- The end may be cleaned by either wiping it with, or soaking it for 10 minutes in 70% Isopropyl Alcohol.
- If the end of the lead is soaked be sure to rinse it with water and air-dry it prior to use on the next patient.



CAUTION

Inspect the end for cracking or breakage, or loss of spring tension that would allow slippage or movement of the sensor from its proper position.

Do not sterilize the end by irradiation, steam or ethylene oxide.

Cleaning and Disinfecting Transducers

Transducer Cleaning Safety



WARNING

Use care when handling and cleaning ultrasound transducers.

Do not use a damaged or defective transducer.

Do not immerse or allow liquid to penetrate a transducer which has had its face or cable sheath compromised.

Failure to follow these precautions can result in serious injury and equipment damage.

Follow these precautions to avoid injury and equipment damage.

Inspect the transducer prior to cleaning for damage or degeneration to the lens, housing, cable and connector.

Do not use or apply liquid cleaning agents to a damaged or defective transducer.

Do not immerse the transducer into any liquid beyond the level specified for that transducer.

Never immerse the transducer connector or transducer adapters into any liquid.

Transducer damage can result from contact with inappropriate coupling or cleaning agents.

Use only cleaning agents which have been approved for the specified transducer.

Do not soak, immerse, or maintain prolonged contact with solutions containing alcohol, bleach, ammonium chloride compounds or hydrogen peroxide.

The level of disinfection required for a device is dictated by the type of tissue it will contact during use. Ensure the solution strength and duration of contact are appropriate for the intended clinical use of the transducer.

Always use protective eyewear and gloves when cleaning, disinfecting or sterilizing any equipment.

Be sure to observe the expiration date of the solution.

Avoid disinfectant contact with the connector label.



CAUTION

Biological hazards may exist if ultrasound transducers are not properly cleaned, disinfected or sterilized.

This is especially true if the transducer comes in contact with mucous membranes or bodily fluids.

Proper cleaning and disinfection are necessary to prevent disease transmission and infection control.

It is the responsibility of the equipment user to verify and maintain the effectiveness of the infection control procedures in use.

For any procedures where the transducer may come in contact with bodily fluids or mucous membranes, the use of a legally marketed, sterile, non-pyrogenic transducer sheath is recommended.

Only use disposable sheaths. Sheaths are never to be reused.

Use caution when using disinfectant products.

Wear rubber gloves and protective eyewear.

Always follow the manufacturer's instructions.

In order for liquid chemical disinfectants to be effective, all visible residues must be removed during the cleaning process.

For effective cleaning, follow the instructions accompanying the cleaner or disinfectant product.

Care should be taken to avoid applying disinfectant agents to the cable-housing junction.

Do not allow any fluids to enter the cable-housing junction.

Do not use any alcohol or alcohol-based products on the transducer cable.

If the transducer shows signs of damage such as cracks, splitting, delamination of the face or cable damage, discontinue use of the transducer and contact your authorized SuperSonic Imagine Service representative for assistance.

Transducer Cleaning and Disinfection Guidance

Cleaning and disinfection is a two step process: a cleaning step followed by a disinfection step.

Cleaning

Cleaning is intended to remove all foreign matter (blood, tissue, protein, scanning gel, etc.) from the device.

Disinfection

The level of disinfection required for a device is dictated by the type of tissue it will contact during use. There are three classifications: non-critical, semi-critical, and critical. These are based on the degree of risk of infection involved in the use of the device.

Non-critical applications are those where the device contacts only intact skin; semi-critical applications are those where the device contacts mucus membranes or minor skin breach; critical applications are those where the device enters a normally sterile environment, sterile tissue or vasculature.

Ultrasound transducers used for non-critical applications generally need only to be cleaned and low-level disinfected between patient uses.

Transducer used in semi-critical application should be cleaned and high level disinfected after use even if a sheath was used.

Transducers used in critical applications should be sterilized and the use of a sterile sheath is recommended. Transducer used in critical application should be cleaned and sterilized after use even if a sheath was used.

General Cleaning and Disinfection Procedures for the Aixplorer® Mach 30 Transducers

The SuperSonic Imagine Aixplorer® Mach 30 transducers are intended for use in non-critical and semi-critical imaging applications. The transducer must be thoroughly cleaned and disinfected after each use. In general, only low-level disinfection is required for non-critical applications of the SuperSonic Imagine Aixplorer® Mach 30 transducer.

For semi-critical applications, high-level disinfection is required and only one of the high-level disinfectants chosen from the list below should be used.

High-level disinfection for semi-critical is recommended, carefully following the manufacturer's instructions with regard to application and contact time as indicated on the product label.

Procedure to Prepare Transducer for Disinfection

1. After every patient exam, carefully wipe the face and housing of the ultrasound transducer to remove any traces of ultrasound coupling gel.
2. Inspect the transducer for any signs of damage such as cracks, splitting, delamination of the face or cable damage. If any damage is noted, do not proceed with the cleaning or disinfecting procedures and call your authorized SuperSonic Imagine Service representative for assistance.
3. Wipe the transducer face, housing and cable with a water-moistened soft cloth. The use of a mild soap, low-level cleaner or enzymatic cleaner (from the table below) is acceptable.
4. If stubborn material has dried on the face or housing of the transducer, carefully scrub the transducer using water moistened gauze, sponge or surgeon's soft bristle brush. Wipe away any material with a water-moistened soft cloth.
5. Rinse the transducer thoroughly with water. Do not allow water to access the cable-housing junction.
6. Air dry or dry using a soft dry cloth.

Disinfection Procedure

1. Always clean the transducer prior to disinfection. (See steps above.)
2. When using an FDA or CE -cleared (as appropriate) disinfecting agent, carefully follow the instructions provided by the manufacturer of the product.
3. For low-level disinfection, the lens and housing of the transducer may be wiped with any of the **cleaners/low level disinfectants** listed in the associated transducer table.
4. For high-level disinfection, the transducer may be wiped or soaked using one of the **disinfectants** listed in the associated transducer table.
5. Air dry or dry using a soft dry cloth.
6. Re-inspect the transducer for any signs of damage such as cracks, splitting, delamination of the face or cable damage before putting the transducer back into use.

Cleaning and Disinfection Products

List of Compatible Products

The table below lists the product compatibility ("YES") with the Aixplorer® Mach 30 probes.

Only use compatible products with Aixplorer® Mach 30 probes.

Solution/system	Manufacturer	Cleaner/Disinfectant	Active ingredient	L18-5 L10-2 MC12-3	E12-3	LV16-5	C6-1X C9-2X LH20-6
Alkaspray GSA (Cidalkan)	Alkapharm	Cleaner Disinfectant	Isopropyl alcohol Alkylamine	YES			
Alkazyme	Alkapharm	Cleaner Disinfectant	Quat. Ammonia	YES			
Anioxyde 1000	Anios	Disinfectant	Peracetic acid	YES	YES		
Cidex OPA (DISOPA in Japan)	Advanced Sterilization Products	Disinfectant	Orthophtalaldehyde	YES	YES	YES	YES
Cidex Plus	Advanced Sterilization Products	Disinfectant	Orthophtalaldehyde				YES
Cidezyme	Johnson and Johnson	Cleaner	Proteolytic enzymes	YES	YES	YES	
Enzol	Advanced Sterilization Products	Cleaner	Proteolytic enzymes				YES
Gigasept FF	Schuller&Mayr	Disinfectant	Succindialdehyde, dimethoxy- tetrahydrofuran	YES	YES		YES
KlenZyme	Steris	Cleaner	Proteolytic enzymes				YES
Linget' Anios	Anios	Cleaner Disinfectant	Ethanol Digluconate de chlorhexidine	YES		YES	YES

Solution/ system	Manufacturer	Cleaner/ Disinfectant	Active ingredient	L18-5 L10-2 MC12-3	E12-3	LV16-5	C6-1X C9-2X LH20-6
			Alkylamino-alkylglycine				
MetriZyme	Metrex	Cleaner	Proteolytic enzymes				YES
Mikrobac Tissues	Bode	Disinfectant	Benzyl-C12-18-alkyldimethyl-ammonium chlorides didecyl- dimethyl-ammonium chloride	YES		YES	
Milton	Milton	Disinfectant	Sodium Hypochlorite				YES
Sani-Cloth Active	PDI	Cleaner Disinfectant	Quat. Ammonia	YES			
Sani-Cloth HB	PDI	Disinfectant	Quat. Ammonia				YES
Sani-Cloth Plus	PDI	Disinfectant	Quat. Ammonia				YES
Sporox	Reckitt & Colman	Disinfectant	Hydrogen Peroxide				YES
Sporox II	Reckitt & Colman	Disinfectant	Hydrogen Peroxide				YES
Steranios	Anios	Disinfectant	Glutaraldehyde	YES	YES		
Steranios OPA	Anios	Disinfectant	Orthophthalaldehyde				YES
Super Sani Cloth	PDI	Disinfectant	Quat. Ammonia				YES
T-Spray	Pharmaceutical Innovations Inc.	Disinfectant	Quat. Ammonia	YES			
Transeptic spray	Parker laboratories	Cleaner	Chlorhexidine Gluconate, Isopropyl Alcohol				YES
Tristel Duo	Tristel Solutions Limited	Disinfectant	Chlorine dioxide	YES	YES		
Tristel Solo	Tristel Solutions Limited	Disinfectant	Hexamethylene-biguanide	YES			

Solution/system	Manufacturer	Cleaner/Disinfectant	Active ingredient	L18-5 L10-2 MC12-3	E12-3	LV16-5	C6-1X C9-2X LH20-6
Trophon	Nanosonics	High-level disinfectant	Hydrogen peroxide mist generated in a disinfection chamber				YES
Wavicide 01	MCC	Disinfectant	Glutaraldehyde				YES



WARNING

For endocavity probes, make sure the cleaner/disinfectant is compatible with mucosa.



NOTE

Some cleaner/disinfectant products may cause coloration or discoloration of the probe housing. This coloration/discoloration does not affect the image quality of the probe.

General Recommendations for all Probes

The above cleaner and disinfectant products have been tested and found to be compatible with SuperSonic Imagine Aixplorer® Mach 30 transducers material solely. Questions regarding efficacy, instructions for use, and proper handling should be directed to the manufacturer. Please check whether the recommended products are approved for use in your country. The use of a non-approved cleaner or disinfectant which results in damage to the probe will void the warranty. The use of products outside of those on this list is to be done at the user's and patient's own risk.

Soaking Limits

If soaking a transducer is required, the L18-5, L10-2, MC12-3 transducers may only be immersed in liquid to a level of 3cm (1.18 in.) above the cable-strain relief junction. The LV16-5, P5-1X, C6-1X, C9-2X, LH20-6 and E12-3 transducers may be immersed in liquid to a level of 1m (39.37in.) above the cable-strain relief junction.

According to the IEC 60529 standard:

- Aixplorer® Mach 30 is IPX0
- The footswitch pedal and the L10-2, L18-5, MC12-3, C6-1X, C9-2X, and LV16-5 transducers are IPX1
- The E12-3, P5-1X and LH20-6 transducers are IPX7

Never immerse the probe connector. Never immerse the cable-connector junction. Do not leave the transducer immersed longer than required for disinfection. See figure below.

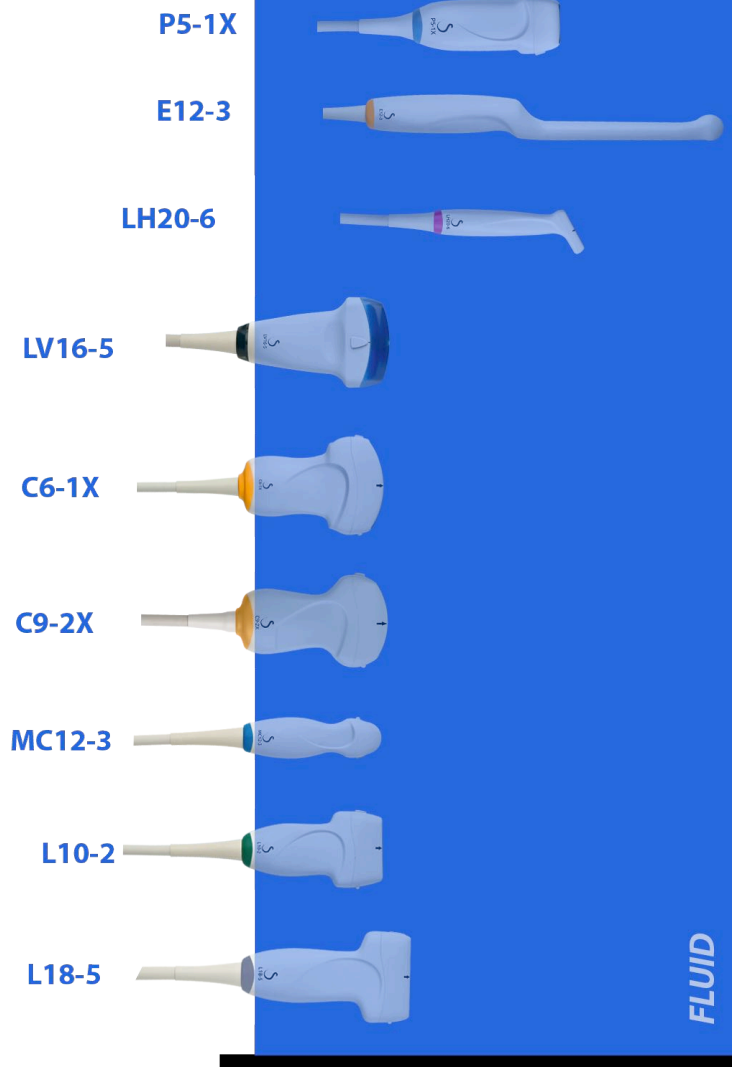

The following figure displays the part of each transducer to be in contact with patients.

Face in contact with patient

P5-1X



E12-3



LH20-6



LV16-5



C6-1X



C9-2X



MC12-3



L10-2



L18-5



Additional Information Regarding Cleaning and Disinfection of Ultrasound Transducers

Additional information regarding cleaning and disinfection of ultrasound transducers can be found in the following references:

Chemical Sterilization and high-level disinfection in health care facilities. ANSI/AAMI ST58:2005 Sterilization and Disinfection of Medical Devices: General Principles. Centers for Disease Control, Division of Healthcare Quality Promotion.

<http://www.cdc.gov/ncidod/hip/sterile/sterilgp.htm> (5-2003) [[http://www.cdc.gov/ncidod/hip/sterile/sterilgp.htm%20\(5-2003\)](http://www.cdc.gov/ncidod/hip/sterile/sterilgp.htm%20(5-2003))]

ODE Device Evaluation Information—FDA Cleared Sterilants and High Level Disinfectants with General Claims for Processing Reusable Medical and Dental Devices.

<http://www.fda.gov>

11 Troubleshooting

If you encounter difficulty in the operation of the system, use the information in this section to help correct the problem.

If the problem is not covered here, contact your Customer Support Representative.

The troubleshooting table below contains a list of symptoms and the action to take to correct the problem.

Symptom	Corrective action
System does not power on	Ensure that the system is plugged in to a functioning outlet, and that the circuit breaker on the rear power is set. Turn on power.
Image quality is poor	Take care of ambient light Adjust gain, TGC and Auto TGC Try with an other probe Adjust position of LCD screen to improve viewing angle If there is no change, contact your customer service representative.
Error message appears on screen	Note the error and contact your customer service representative.
System does not recognize the transducer	Disconnect, reconnect and reselect the transducer. If there is no change, contact your customer service representative.
DVD does not work	Find another DVD disk to store data. If there is no change, contact your customer service representative.
The system does not start, the fans do not spin	Ensure that the system is plugged in to a functioning outlet, and that the circuit breaker on the rear power is set. Turn on power. If there is no change, contact your customer service representative.
The main monitor does not turn on (fans run and control panel is on)	Check the cables at the back of the monitor Reboot If there is no change, contact your customer service representative.
The touch screen display is off when the system is ready	Reboot.

Symptom	Corrective action
	If no change, contact your customer service representative.
The control panel is off	Reboot. If no change, contact your customer service representative.
The system displays a banner indicating a HW problem	Reboot. If banner stay on, contact your customer service representative.
“GRUB error” is displayed at boot time.	Internal hard drive failure. Service is needed. Contact your customer service representatives
Splash screen is up but the progress bar has not moved for more than 5 minutes	Operating system is damaged. Service is needed. Contact your customer service representative.
A broom icon appears in the icon area of the screen	This icon appears once a month, it is to remind you to check the air filters. Stop the system and verify the filters Click on the icon A pop-up window appears Click yes on the pop-up window The icon disappears
Artefact, white cone(s) in the B-mode, and/or colored cone(s) on the color flow image, starting from the skin line	Reboot the system. If there is no change, contact you customer service representative.
An audible alert rings. A pop-up window may additionally appear.	Battery error. Note the error code displayed at the rear of the system and refer to the Service.

12 References

General References

Abbott, JG. Rationale and derivation of MI and TI - a review. *Ultrasound in Med. and Biol.* 25:431-441; 1999.

American Institute of Ultrasound in Medicine (AIUM). Bioeffects and safety of diagnostic ultrasound. Laurel, MD: AIUM Publications; 1993.

American Institute of Ultrasound in Medicine/National Electrical Manufacturers Association (AIUM/NEMA). Standard for real-time display of thermal and mechanical acoustic output indices on diagnostic ultrasound equipment, Revision 1. Laurel, MD: AIUM Publications; 1998a.

American Institute of Ultrasound in Medicine/National Electrical Manufacturers Association (AIUM/NEMA). Acoustic output measurement standard for diagnostic ultrasound equipment. Laurel, MD: AIUM Publications; 1998b.

American Institute of Ultrasound in Medicine (AIUM). Medical ultrasound safety. Rockville, MD: AIUM Publications; 2002.

American Institute of Ultrasound in Medicine (AIUM). Standard Methods for Measuring Performance of Pulse Echo Ultrasound Imaging Equipment. Rockville, MD: AIUM Publications; 1991.

American Institute of Ultrasound in Medicine (AIUM). Methods for Measuring Performance of Pulse-Echo Ultrasound Equipment, Part II: Digital Methods. Rockville, MD: AIUM Publications; 1995a.

American Institute of Ultrasound in Medicine (AIUM). AIUM Quality Assurance Manual for Gray-Scale Ultrasound Scanners. Rockville, MD: AIUM Publications; 1995b.

American Institute Of Ultrasound In Medicine. Standard For Real-Time Display Of Thermal And Mechanical Acoustic Output Indices On Diagnostic Ultrasound Equipment. Laurel, Maryland: AIUM, 1992.

American Institute of Ultrasound in Medicine (AIUM). Mechanical Bioeffects from Diagnostic Ultrasound: AIUM Consensus Statements. *J. Ultrasound in Medicine* 19: number 2; (February 2000). (Also available from AIUM Publications.).

Apfel, R.E. and Holland, C.K. Gauging the likelihood of cavitation from short-pulse, low duty cycle diagnostic ultrasound. *Ultrasound in Med. and Biol.* 17:179-185;1991.

Baggs, R., Penney, D.P., Cox, C., Child, S.Z., Raeman, C.H., Dalecki, D. and Carstensen, E.L. Thresholds for ultrasonically induced lung hemorrhage in neonatal swine. *Ultrasound in Med. and Biol.* 22:119-128; 1996.

Barnett, S.B., ter Haar, G.R., Ziskin, M.C., Rott, H.D., Duck, F.A. and Maeda, K. International recommendations and guidelines for the safe use of diagnostic ultrasound in medicine. *Ultrasound in Med. and Biol.* 26:355-366; 2000.

Bly, S.H.P., Vlahovich, S., Mabee, P.R. and Hussey, R.G. Computed estimates of maximum temperature elevations in fetal tissues during transabdominal pulsed Doppler examinations. *Ultrasound in Med. and Biol.* 18:389-397; 1992.

Bosward, K.L., Barnett, S.B., Wood, A.K.W., Edwards, M.J. and Kossoff, G. Heating of guinea-pig fetal brain during exposure to pulsed ultrasound. *Ultrasound in Med. and Biol.* 19:415-424; 1993.

Carstensen, E.L., Duck, F.A., Meltzer, R.S., Schwarz, K.Q., Keller, B. Bioeffects in echocardiography. *Echocardiography* 6:605-623; 1992.

Child, S.Z., Hartman, C.L., McHale, L.A and E.L. Carstensen. Lung damage from exposure to pulsed ultrasound. *Ultrasound in Med. and Biol.* 16:817-825; 1990.

Dalecki, D., Raeman CH, Child SZ, et al, . The influence of contrast agents on hemorrhage produced by lithotripter fields. *Ultrasound in Med. and Biol.* 23:1435-1439; 1997.

Dalecki, D., Child, S.Z., Raeman, C.H., Cox, C. and Carstensen, E.L. Ultrasonically induced lung hemorrhage in young swine. *Ultrasound in Med. and Biol.* 23:777-781; 1997.

Dalecki, D., Child, S.Z., Raeman, C.H. and Cox, C. Hemorrhage in murine fetuses exposed to pulsed ultrasound. *Ultrasound in Med. and Biol.* 25:1139-1144; 1999.

Doody, C. Porter, H., Duck, F.A. and Humphrey, V.F. In vitro heating of human fetal vertebra by pulsed diagnostic ultrasound. *Ultrasound in Med. and Biol.* 25:1289-1294; 1999.

Duck, F.A., Starritt, H.C., ter Haar, G.R. and Lunt, M.J. Surface heating of diagnostic ultrasound transducers. *Br. J. Radiology* 67:1005-1013; 1989.

Duggan, P.M., Liggins, G.C. and Barnett, S.B. Ultrasonic heating of the brain of the fetal sheep in utero. *Ultrasound in Med. and Biol.* 21:553-560; 1995.

Duggan, P.M. and McCowan, L.M.E. Reference Ranges and Ultrasonographic Exposure Conditions for Pulsed Doppler Sonographic Studies of the Fetal Internal Carotid Artery. *J Ultrasound in Medicine* 12:719 - 722; 1993.

European Federation of Societies for Ultrasound in Medicine and Biology (EFSUMB) Guidelines and Recommendations on the Clinical Use of Ultrasound Elastography. Part 1 : Basic principles and technology; EFSUMB, *Ultraschall Med.* 2013 Apr; 34(2): 169-84.

European Federation of Societies for Ultrasound in Medicine and Biology (EFSUMB) Guidelines and Recommendations on the Clinical Use of Ultrasound Elastography. Part 2 : Clinical Applications; EFSUMB, *Ultraschall Med.* 2013 Jun; 34(3): 238-53

Frizzell, L.A., Chen, E. and Lee, C. Effects of pulsed ultrasound on the mouse neonate: hind limb paralysis and lung hemorrhage. *Ultrasound in Med. and Biol.* 20:53-63; 1994.

Henderson, J., Willson, K., Jago, J.R. and Whittingham, T. A survey of the acoustic outputs of diagnostic ultrasound equipment in current clinical use. *Ultrasound in Med. and Biol.* 21:699-705; 1995.

Holland, C.K., Deng, C.X., Apfel, R.E., Alderman, J.L., Fernandez, L.A., and Taylor, K.J.W. Direct evidence of cavitation in vivo from diagnostic ultrasound. *Ultrasound in Med. and Biol.* 22:917-925; 1996.

Lele, P.P. Local hyperthermia by ultrasound for cancer therapy. In: Nyborg, W.L.; Ziskin, M.C., eds. *Biological effects of ultrasound. Clinics in diagnostic ultrasound*, Vol.16. New York: Churchill Livingstone:135-155; 1985.

Lopez, H. How to Interpret the Ultrasound Output Display Standard for Higher Acoustic Output Diagnostic Ultrasound Devices. *J. Ultrasound in Medicine*, Vol 17, pg 535 (1998).

Miller, D.L. and Gies, R.A. Gas-body-based contrast agent enhances vascular bioeffects of 1.09 Mhz ultrasound on mouse intestine. *Ultrasound in Med. and Biol.* 24:1201-1208; 1998.

Meltzer, R.S., Adsumelli, R., Risher, W.H., et al., Lack of lung hemorrhage in humans after intraoperative transesophageal echocardiography with ultrasound exposure conditions similar to those causing lung hemorrhage in laboratory animals. *J. Am. Soc. Echocardiography* 11:57-60; 1998.

National Council on Radiation Protection and Measurements (NCRP). Exposure criteria for medical diagnostic ultrasound: I. Criteria based on thermal mechanisms. Bethesda, MD: NCRP; June 1, 1992.

National Council on Radiation Protection and Measurements (NCRP). Exposure criteria for medical diagnostic ultrasound: II. Criteria based on mechanical mechanisms. Bethesda, MD: NCRP; in preparation

O'Brien, W.D. and Zachary, J.F. Lung damage assessment from exposure to pulsed-wave ultrasound in the rabbit, mouse and pig. *IEEE Trans Ultras Ferro, Freq Cont* 44: 473-485; 1997.

O'Neill, T.P., Winkler, A.J. and Wu, J. Ultrasound heating in a tissue-bone phantom. *Ultrasound in Med. and Biol.* 20:579-588; 1994.

Patton, C.A., Harris, G.R. and Phillips, R.A. Output Levels and Bioeffects Indices from Diagnostic Ultrasound Exposure Data Reported to the FDA. *IEEE Trans Ultras Ferro, Freq Cont* 41:353-359; 1994.

Ramnarine, K.V., Nassiri, D.K., Pearce, J.M., Joseph, A.E.A., Patel, R.H. and Varma, T.R. Estimation of in situ ultrasound exposure during obstetric examinations. *Ultrasound in Med. and Biol.* 19:319-329; 1993.

Shaw, A., Preston, R.C. and Bond, A.D. Assessment of the likely thermal index values for pulsed Doppler ultrasonic equipment - Stage I: calculation based on manufacturers' data. NPL Report CIRA(EXT) 018; 1997.

Shaw, A., Pay, N.M. and Preston, R.C. Assessment of the likely thermal index values for pulsed Doppler ultrasonic equipment - Stages II and III: experimental assessment of scanner/transducer combinations. NPL Report CMAM 12; 1998.

Siddiqi, T.A., O'Brien, W.D., Meyer, R.A., Sullivan, J.M. and Miodovnik, M. In situ human obstetrical ultrasound exposimetry:

estimates of derating factors for each of three different tissue models. *Ultrasound in Med. and Biol.* 21:379-391; 1995.

Tarantal, A.F. and Canfield, D.R. Ultrasound-induced lung hemorrhage in the monkey. *Ultrasound in Med. and Biol.* 20:65-72; 1994.

U.S. Food and Drug Administration (FDA). Information for manufacturers seeking marketing clearance of diagnostic ultrasound systems and transducers. Rockville, MD: FDA; Sept 30, 1997.

World Federation for Ultrasound in Medicine and Biology (WFUMB) WFUMB Symposium on Safety and Standardisation in Medical Ultrasound, Chapter 1, ed., Barnett, S.B. and Kossoff, G. *Ultrasound in Med. and Biol.* 18:739-750; 1992.

World Federation for Ultrasound in Medicine and Biology (WFUMB) WFUMB Symposium on Safety of Ultrasound in Medicine. Conclusions and recommendations on thermal and non-thermal mechanisms for biological effects of ultrasound. ed., Barnett, S.B. *Ultrasound in Med. and Biol.* 24: Supplement 1, 1998.

Zachary, J.F. and O'Brien, W.D., Jr. Lung lesions induced by continuous- and pulsed-wave (diagnostic) ultrasound in mice, rabbits and pigs. *Vet Pathol* 32:43-54; 1995.

Obstetrical References

The detailed tables and equations listed below are available in the Obstetrical References Guide. You may download it at the following link: <https://www.supersonicimagine.com/Instruction-for-use>.

Fetal Growth Equations and Tables

Abdominal Circumference (AC by GA)

ASUM: ASUM and Campbell Westerway S , Ultrasonic fetal Measurement Standards for an Australian Population, ASUM, 2003

CFEF: Crequat J, Duyme M and Brodaty G, Fetal growth charts by the French College of fetal ultrasonography and the Inserm U 155 , Biometry 2000, 28, pp 435-455, 2000

Hadlock: Hadlock F.P, Deter R.L, Harrist R.B. and Park S.K, Estimating fetal age: computer-assisted analysis of multiple fetal growth parameters, Radiology, 152, pp 497-501, 1984

Merz: Merz E, Goldhofer W and Timor-Tritsch E , Ultrasound in Gynecology and Obstetrics, Textbook and Atlas, Georg Thieme Verlag , 1991

Biparietal Diameter (BPD by GA)

ASUM: ASUM and Campbell Westerway S , Ultrasonic fetal Measurement Standards for an Australian Population, ASUM, 2003

CFEF: L.J. Salomon, M. Duyme, J. Crequat, G. Brodaty, C. Talmant, N. Fries and M. Althuser - CFEF - Collège Français d'Echographie Foetale, Paris, France - Ultrasound Obstet Gynecol 2006; 28: 193-198, 2006

Hadlock: Hadlock F.P, Deter R.L, Harrist R.B. and Park S.K, Estimating fetal age: computer-assisted analysis of multiple fetal growth parameters, Radiology, 152, pp 497-501, 1984

Merz: Merz E, Goldhofer W and Timor-Tritsch E , Ultrasound in Gynecology and Obstetrics, Textbook and Atlas, Georg Thieme Verlag , 1991

Crown-Rump Length (CRL by GA)

Hansmann: Hansmann, Hackeloer, Staudach and Wittman, Ultrasound Diagnosis in Obstetrics and Gynecology, Springer-Verlag, New York, 1986

ASUM: ASUM and Campbell Westerway S , Ultrasonic fetal Measurement Standards for an Australian Population, ASUM, 2003

CFEF: Crequat J, Duyme M and Brodaty G, Fetal growth charts by the French College of fetal ultrasonography and the Inserm U 155 , Biometry 2000, 28, pp 435-455, 2000

Femur Length (FL by GA)

Hadlock: Hadlock F.P, Deter R.L, Harrist R.B. and Park S.K, Estimating fetal age: computer-assisted analysis of multiple fetal growth parameters, Radiology, 152, pp 497-501, 1984

Jeanty: Ultrasonic Evaluation of Fetal Limb Growth, Jeanty et al., June 1982, Radiology 143: 751-754

Merz: Merz E, Goldhofer W and Timor-Tritsch E , Ultrasound in Gynecology and Obstetrics, Textbook and Atlas, Georg Thieme Verlag , 1991

Head Circumference (HC by GA)

ASUM: ASUM and Campbell Westerway S , Ultrasonic fetal Measurement Standards for an Australian Population, ASUM, 2003

CFEF: Crequat J, Duyme M and Brodaty G, Fetal growth charts by the French College of fetal ultrasonography and the Inserm U 155 , Biometry 2000, 28, pp 435-455, 2000

Hadlock: Hadlock F.P, Deter R.L, Harrist R.B. and Park S.K, Estimating fetal age: computer-assisted analysis of multiple fetal growth parameters, Radiology, 152, pp 497-501, 1984

Jeanty: Jeanty P and Romero R, Obstetrical Ultrasound, McGraw-Hill, 1984

Merz: Merz E, Goldhofer W and Timor-Tritsch E , Ultrasound in Gynecology and Obstetrics, Textbook and Atlas, Georg Thieme Verlag , 1991

Humerus Length (HL by GA)

ASUM: ASUM and Campbell Westerway S , Ultrasonic fetal Measurement Standards for an Australian Population, ASUM, 2003

Jeanty: Ultrasonic Evaluation of Fetal Limb Growth, Jeanty et al., June 1982, Radiology 143: 751-754

Occipito-Frontal Diameter (OFD by GA)

ASUM: ASUM and Campbell Westerway S , Ultrasonic fetal Measurement Standards for an Australian Population, ASUM, 2003

Trans-Abdominal Diameter (TAD by GA)

CFEF: Crequat J, Duyme M and Brodaty G, Fetal growth charts by the French College of fetal ultrasonography and the Inserm U 155 , Biometry 2000, 28, pp 435-455, 2000

Tibia (TIB by GA)

Jeanty: Ultrasonic Evaluation of Fetal Limb Growth, Jeanty et al., June 1982, Radiology 143: 751-754

Gestational Age Equations and Tables

Abdominal Circumference (GA by AC)

ASUM: ASUM and Campbell Westerway S , Ultrasonic fetal Measurement Standards for an Australian Population, ASUM, 2003

CFEF: Crequat J, Duyme M and Brodaty G, Fetal growth charts by the French College of fetal ultrasonography and the Inserm U 155 , Biometry 2000, 28, pp 435-455, 2000

Hadlock: Hadlock F.P, Deter R.L, Harrist R.B. and Park S.K, Estimating fetal age: computer-assisted analysis of multiple fetal growth parameters, Radiology, 152, pp 497-501, 1984

Hansmann: Hansmann, Hackeloer, Staudach and Wittman, Ultrasound Diagnosis in Obstetrics and Gynecology, Springer-Verlag, New York, 1986

Merz: Merz E, Goldhofer W and Timor-Tritsch E , Ultrasound in Gynecology and Obstetrics, Textbook and Atlas, Georg Thieme Verlag , 1991

Biparietal Diameter (GA by BPD)

ASUM: ASUM and Campbell Westerway S , Ultrasonic fetal Measurement Standards for an Australian Population, ASUM, 2003

CFEF: Crequat J, Duyme M and Brodaty G, Fetal growth charts by the French College of fetal ultrasonography and the Inserm U 155 , Biometry 2000, 28, pp 435-455, 2000

Hadlock: Hadlock F.P, Deter R.L, Harrist R.B. and Park S.K, Estimating fetal age: computer-assisted analysis of multiple fetal growth parameters, Radiology, 152, pp 497-501, 1984

Hansmann: Hansmann, Hackeloer, Staudach and Wittman, Ultrasound Diagnosis in Obstetrics and Gynecology, Springer-Verlag, New York, 1986

Merz: Merz E, Goldhofer W and Timor-Tritsch E , Ultrasound in Gynecology and Obstetrics, Textbook and Atlas, Georg Thieme Verlag , 1991

Crown-Rump Length (GA by CRL)

ASUM: ASUM and Campbell Westerway S , Ultrasonic fetal Measurement Standards for an Australian Population, ASUM, 2003

Hansmann: Hansmann, Hackeloer, Staudach and Wittman, Ultrasound Diagnosis in Obstetrics and Gynecology, Springer-Verlag, New York, 1986

Femur Length (GA by FL)

ASUM: ASUM and Campbell Westerway S , Ultrasonic fetal Measurement Standards for an Australian Population, ASUM, 2003

CFEF: Crequat J, Duyme M and Brodaty G, Fetal growth charts by the French College of fetal ultrasonography and the Inserm U 155 , Biometry 2000, 28, pp 435-455, 2000

Chitty: Altman D.G and Chitty L.S, New charts for ultrasound dating of pregnancy, Ultrasound Obstet. Gynecol, Vol 10, pp 174-191, 1997

Hadlock: Hadlock F.P, Deter R.L, Harrist R.B. and Park S.K, Estimating fetal age: computer-assisted analysis of multiple fetal growth parameters, Radiology, 152, pp 497-501, 1984

Hansmann: Hansmann, Hackeloer, Staudach and Wittman, Ultrasound Diagnosis in Obstetrics and Gynecology, Springer-Verlag, New York, 1986

Jeanty: Ultrasonic Evaluation of Fetal Limb Growth, Jeanty et al., June 1982, Radiology 143: 751-754

Merz: Merz E, Goldhofer W and Timor-Tritsch E , Ultrasound in Gynecology and Obstetrics, Textbook and Atlas, Georg Thieme Verlag , 1991

Gestational Sac (GA by GS)

Daya: Daya S, Woods S, Ward S, Lappalainen R and Caco R, Early pregnancy assessment with transvaginal ultrasound scanning, CMAJ, Vol 144(4), pp 441-446, 1991

Head Circumference (GA by HC)

ASUM: ASUM and Campbell Westerway S , Ultrasonic fetal Measurement Standards for an Australian Population, ASUM, 2003

CFEF: Crequat J, Duyme M and Brodaty G, Fetal growth charts by the French College of fetal ultrasonography and the Inserm U 155 , Biometry 2000, 28, pp 435-455, 2000

Chitty: Altman D.G and Chitty L.S, New charts for ultrasound dating of pregnancy, Ultrasound Obstet. Gynecol, Vol 10, pp 174-191, 1997

Hadlock: Hadlock F.P, Deter R.L, Harrist R.B. and Park S.K, Estimating fetal age: computer-assisted analysis of multiple fetal growth parameters, Radiology, 152, pp 497-501, 1984

Hansmann: Hansmann, Hackeloer, Staudach and Wittman, Ultrasound Diagnosis in Obstetrics and Gynecology, Springer-Verlag, New York, 1986

Jeanty: Jeanty P and Romero R, Obstetrical Ultrasound, McGraw-Hill, 1984

Merz: Merz E, Goldhofer W and Timor-Tritsch E , Ultrasound in Gynecology and Obstetrics, Textbook and Atlas, Georg Thieme Verlag , 1991

Humerus Length (GA by HL)

ASUM: ASUM and Campbell Westerway S , Ultrasonic fetal Measurement Standards for an Australian Population, ASUM, 2003

Jeanty: Ultrasonic Evaluation of Fetal Limb Growth, Jeanty et al., June 1982, Radiology 143: 751-754

Occipito-Frontal Diameter (GA by OFD)

ASUM: ASUM and Campbell Westerway S , Ultrasonic fetal Measurement Standards for an Australian Population, ASUM, 2003

Hansmann: Hansmann, Hackeloer, Staudach and Wittman, Ultrasound Diagnosis in Obstetrics and Gynecology, Springer-Verlag, New York, 1986

Trans-Abdominal Diameter (GA by TAD)

CFEF: Crequat J, Duyme M and Brodaty G, Fetal growth charts by the French College of fetal ultrasonography and the Inserm U 155 , Biometry 2000, 28, pp 435-455, 2000

Tibia (GA by TIB)

Jeanty: Ultrasonic Evaluation of Fetal Limb Growth, Jeanty et al., June 1982, Radiology 143: 751-754

Ulna (GA by ULNA)

Jeanty: Ultrasonic Evaluation of Fetal Limb Growth, Jeanty et al., June 1982, Radiology 143: 751-754

Estimated Fetal Weight Equations and Tables

Gestational Age (EFW by GA)

CFEF: Courbe d'estimation de poids foetal 2014 par le CFEF - Janvier 2015 - Massoud M., Duyme M., Fontanges M., Collège Français d'Echographie Foetale (CFEF), Combourieu D. - Journal de Gynécologie Obstétrique et Biologie de la Reproduction - Accepté le 15 janvier 2015

Doubilet: J Ultrasound Med. 1997 Apr

Hadlock: Hadlock FP1, Harrist RB, Martinez-Poyer J, In utero analysis of fetal growth: a sonographic weight standard, Radiology. 1991 Oct, 181(1):129-33.

Oken (all): BMC Pediatr. 2003, 3:6. Published online 2003 Jul 8. doi:10.1186/1471-2431-3-3 A nearly continuous measure of birth weight for gestational age using a United States national reference Emily Oken, Ken P Kleinman, Janet Rich-Edwards, and Matthew W Gillman

Oken (females): BMC Pediatr. 2003, 3:6. Published online 2003 Jul 8. doi:10.1186/1471-2431-3-6 A nearly continuous measure of birth weight for gestational age using a United States national reference Emily Oken, Ken P Kleinman, Janet Rich-Edwards, and Matthew W Gillman

Oken (males): BMC Pediatr. 2003, 3:6. Published online 2003 Jul 8. doi:10.1186/1471-2431-3-6 A nearly continuous measure of birth weight for gestational age using a United States national reference Emily Oken, Ken P Kleinman, Janet Rich-Edwards, and Matthew W Gillman

Abdominal Circumference and Biparietal Diameter (EFW by AC, BPD)

Hadlock: Hadlock F.P, Harrist R.B, Carpenter R.J, Deter R.L and Park S.K, Sonographic estimation of fetal weight. The value of femur length in addition to head and abdomen measurements, Radiology, 150, pp 535-540, 1984

Merz: Merz E, Goldhofer W and Timor-Tritsch E , Ultrasound in Gynecology and Obstetrics, Textbook and Atlas, Georg Thieme Verlag , 1991

Abdominal Circumference, Biparietal Diameter and Femur Length (EFW by AC, BPD, FL)

Hadlock: Hadlock F.P, Harrist R.B, Sharman R.S, Deter R.L, Park S.K, Estimation of fetal weight with the use of head, body, and

femur measurements--a prospective study, Am.J.Obstet.Gynecol., 151, pp 333-337, 1985

Abdominal Circumference, Biparietal Diameter, Femur Length and Head Circumference (EFW by AC, BPD, FL, HC)

Hadlock: Hadlock F.P, Harrist R.B, Sharman R.S, Deter R.L, Park S.K, Estimation of fetal weight with the use of head, body, and femur measurements--a prospective study, Am.J.Obstet.Gynecol., 151, pp 333-337, 1985

Abdominal Circumference and Femur Length (EFW by AC, FL)

Hadlock: Hadlock F.P, Harrist R.B, Sharman R.S, Deter R.L, Park S.K, Estimation of fetal weight with the use of head, body, and femur measurements--a prospective study, Am.J.Obstet.Gynecol., 151, pp 333-337, 1985

Abdominal Circumference, Femur Length and Head Circumference (EFW by AC, FL, HC)

Hadlock: Hadlock F.P, Harrist R.B, Sharman R.S, Deter R.L, Park S.K, Estimation of fetal weight with the use of head, body, and femur measurements--a prospective study, Am.J.Obstet.Gynecol., 151, pp 333-337, 1985

Abdominal Circumference and Head Circumference (EFW by AC, HC)

Hadlock: Hadlock F.P, Harrist R.B, Carpenter R.J, Deter R.L and Park S.K, Sonographic estimation of fetal weight. The value of femur length in addition to head and abdomen measurements, Radiology, 150, pp 535-540, 1984

Biparietal Diameter and Transverse Thoracic Diameter (EFW by BPD, TTD)

Hansmann: Hansmann, Hackeloer, Staudach and Wittman, Ultrasound Diagnosis in Obstetrics and Gynecology, Springer-Verlag, New York, 1986



SuperSonic Imagine, S.A.

Les Jardins de la Duranne - Bât. E et F
510 rue René Descartes
F - 13857 Aix-en-Provence, Cedex - France

Telephone: +33 (0)442 99 24 32
Email: contactsFR@supersonicimagine.fr

