

# AIXPLO~~R~~RER®

MultiWave™

## User's Guide

User's Guide Ref. :  
SSIP01123  
Revision 08A  
October 2013







### **SuperSonic Imagine**

510, rue René Descartes Bat F  
13857 Aix en Provence Cedex

SuperSonic Imagine Ultrasound products may be manufactured under or operate in accordance with one or more of the following United States patents and corresponding patents in other countries:

#### **U.S. Patent Numbers:**

- (US) 5606971
- (US) 5810731
- (US) 20090234230 (pending)

#### **International Patent Numbers:**

- (WO) 2004021038
- (WO) 2008023127

#### **French Patent Numbers:**

- (FR) 2905180
- (FR) 2844058

Other patent applications are pending in various countries.



The software used for this system includes software owned by SuperSonic Imagine and licensed to SuperSonic Imagine by a licensor.

Availability of this software and related documents is restricted.

The software and related documents must be used only for this system.

The intellectual property of this software and related documents is not assigned to you.

You must not copy the software or documents, nor modify the software in whole or in part.

You must not recompile or reassemble the software.

You must not assign, disclose, transfer, or sublicense the software or documents to a third party.

The ultrasound system software is subjected to the US and French Export and Administration Laws and Regulations and you must not export or re-export the software in whole or in part unless properly authorized by the US or French government.

The information in the documents, or programs in the software are subject to change without notice.



## **CAUTION**

No modification of this equipment is allowed.

The following names are trademarked or registered by SuperSonic Imagine, Inc:

- Aixplorer®
- The Theragnostic Company™
- ShearWave™ Elastography
- SWE™ Mode
- Q-Box™
- UltraFast™ Imaging
- SuperCompound™
- UltimateFocus™
- SuperRes™
- TissueTuner™
- SonicTouch™
- SonicSoftware™
- ManualTouchTGC™
- SuperLinear™ 15-4 transducer
- SuperCurved™ 6-1 transducer
- SuperEndocavity™ 12-3 transducer
- SuperLinearVolumetric™ 16-5 transducer
- SuperLinear™ 10-2 transducer
- SuperMicroConvex™ 12-3 transducer
- TouchRing™
- SonicResearch™
- MultiWave™
- Thy-RADS™
- ReportBuilder™
- UltraFast™ Doppler



# Table of Contents

<b>1. Introduction</b> .....	<b>1</b>
<b>Welcome!</b> .....	<b>3</b>
<b>About this User's Guide</b> .....	<b>4</b>
<b>About this Device</b> .....	<b>5</b>
General Description .....	5
Intended Use .....	5
Indications for Use .....	6
Contraindications .....	6
Prescription Device .....	7
Conformance Standards .....	7
Certifications .....	8
<b>Contact Us</b> .....	<b>9</b>
France .....	9
North America .....	9
United Kingdom .....	9
Germany .....	10
China .....	10
Service .....	10
<b>Service</b> .....	<b>11</b>
<b>Upgrades and Updates</b> .....	<b>12</b>
<b>2. Physical Overview</b> .....	<b>13</b>
<b>Dimensions</b> .....	<b>15</b>
<b>Electrical Operating Requirements</b> .....	<b>16</b>
<b>Input/Output Connectors</b> .....	<b>17</b>
USB Ports .....	17
DVI Port .....	19
CD/DVD Drive .....	19
<b>Printers</b> .....	<b>21</b>
Integrated Printers (optional) .....	21
Additional Printer .....	21
<b>Additional Video Devices</b> .....	<b>23</b>
<b>Temperature, Pressure and Humidity Limits</b> .....	<b>25</b>
<b>Receiving and Storing Aixplorer®</b> .....	<b>25</b>
Storage of the Device .....	25
Safe Disposal of the Device .....	26

<b>3. Safety</b>	<b>27</b>
<b>Definition of Precaution Levels</b>	<b>29</b>
<b>Symbols</b>	<b>30</b>
<b>General Equipment Safety</b>	<b>32</b>
<b>Electrical Safety</b>	<b>34</b>
<b>Electromagnetic Interference</b>	<b>35</b>
Recommended Separation Distances Between Portable and Mobile RF Communications Equipment and Aixplorer	37
Declaration of Electromagnetic Emissions	40
Declaration of Immunity	41
<b>Thermal Safety</b>	<b>44</b>
<b>Mechanical Safety</b>	<b>45</b>
<b>Safely Performing Ultrasound Examinations     with the SuperSonic Imagine Aixplorer®     System</b>	<b>47</b>
Bioeffects and Biophysics of Ultrasound Interactions	47
Thermal Mechanisms	56
Non-thermal Mechanisms	63
Benefits of Ultrasound Versus Risks	67
The ALARA Principle	71
The Output Display Standard	75
Practicing the ALARA Principle	82
<b>Alarm System</b>	<b>99</b>
<b>4. System Overview</b>	<b>105</b>
<b>Description of the System</b>	<b>107</b>
<b>Monitor and Articulated Arm</b>	<b>108</b>
<b>Control Panel</b>	<b>109</b>
How to Move the Control Panel Up and Down	109
How to Swivel the Control Panel	109
Speakers and Audio Adjustment	109
<b>Transducers</b>	<b>111</b>
Connecting a Transducer	111
Storing a Transducer	112
Using the Cable Holder	112
<b>On-Cart Storage</b>	<b>113</b>
Gel Holders	113



Storage Area .....	114
<b>Mobility .....</b>	<b>115</b>
Handles .....	115
Wheel Locks .....	116
Foot Rests .....	116
<b>Moving the System .....</b>	<b>117</b>
Preparing to Move the System .....	117
Moving the System .....	117
<b>Connecting the Power Cable and Protective Earth .....</b>	<b>119</b>
Information concerning the terminal to which the potential equalization conductor is to be connected	
 (▽): .....	120
<b>Compatible Accessories and Kits .....</b>	<b>120</b>
Gels .....	120
Transducer Sheaths .....	121
Cleaning Solutions .....	128
Printer Paper and Toner .....	128
Biopsy Guides .....	129
<b>5. Using the System .....</b>	<b>131</b>
<b>Conventions .....</b>	<b>133</b>
Conventions Used in this User's Guide .....	133
Conventions Used in the System .....	133
Knobology .....	134
<b>Getting Started .....</b>	<b>137</b>
Turning the System On and Off .....	137
Setting the time and date .....	140
Getting Connected to a Network .....	140
Selecting a Transducer .....	140
Beginning an Exam .....	142
Ending an Exam .....	148
<b>Imaging Modes .....</b>	<b>149</b>
General Information on Imaging Modes .....	149
Common Imaging Controls .....	155
B-Mode Imaging .....	163
ShearWave™ Elastography .....	182
Color Mode Imaging .....	191
Pulsed Wave Doppler Mode .....	209
3D Imaging .....	221

Contrast Enhanced Ultrasound Imaging (CEUS) .....	230
M-Mode Imaging .....	240
<b>Analyzing an Image .....</b>	<b>248</b>
Using Body Markers .....	248
Annotating the screen .....	250
Performing Measurements .....	254
BI-RADS® Analysis .....	288
Thy-RADS™ Analysis .....	291
<b>6. Reports .....</b>	<b>295</b>
<b>Description of the Report Feature .....</b>	<b>297</b>
<b>Report Builder .....</b>	<b>297</b>
Description of the Report Builder .....	297
Patient Information .....	299
Images .....	300
Measurements .....	302
Worksheet .....	303
Conclusion .....	307
<b>Generating Reports .....</b>	<b>308</b>
<b>Printing Reports .....</b>	<b>308</b>
<b>7. Image and Data Management .....</b>	<b>309</b>
<b>Saving Data .....</b>	<b>311</b>
Capturing Images and Clips .....	311
Reviewing an Exam .....	315
Printing Images .....	319
Sending a Study .....	321
<b>Deleting exams and images .....</b>	<b>327</b>
To delete one or more images .....	327
To delete exams .....	327
<b>Image Query and Retrieve .....</b>	<b>328</b>
General Information about Query-Retrieve .....	328
Performing a Query .....	330
Performing a Retrieve .....	332
Displaying and Navigating Retrieved Images .....	333
Exiting Query and Retrieve .....	335
<b>Ending an Exam .....</b>	<b>335</b>
<b>Continuing an Exam .....</b>	<b>335</b>
<b>8. Customizing the System .....</b>	<b>337</b>
<b>Description of the System Configuration</b>	
.....	<b>339</b>

<b>System/Display</b> .....	<b>340</b>
Description of the System/Display Tab .....	340
System .....	340
Regional parameters .....	342
Exam .....	344
<b>Device Settings</b> .....	<b>346</b>
Description of the Device Settings Tab .....	346
Media Settings .....	346
Media Association .....	348
System DICOM options .....	349
<b>Administration</b> .....	<b>352</b>
Description of the Administration Tab .....	352
Devices .....	353
Network Configuration .....	354
Network Tools .....	355
Disk Maintenance .....	356
Medical Staff .....	358
<b>Presets</b> .....	<b>359</b>
Description of the Presets Tab .....	359
Annotation .....	360
Bodymarker .....	362
Imaging Presets .....	365
<b>Measurements</b> .....	<b>370</b>
Description of the Measurements Tab .....	370
Measures .....	370
Labels and Calculations .....	371
Packages .....	372
Obstetrics .....	374
<b>System Diagnostics</b> .....	<b>376</b>
<b>9. System Care &amp; Maintenance</b> .....	<b>377</b>
<b>Changing Printer Paper and Toner</b> .....	<b>379</b>
<b>Cleaning the System</b> .....	<b>379</b>
Cleaning Frequency .....	379
Cleaning the Exterior of the Machine .....	381
Cleaning the Monitor .....	381
Cleaning the Touch Screen Display .....	381
Cleaning Air Filters .....	382
<b>Cleaning and Disinfecting Transducers</b> ....	<b>384</b>
Transducer Cleaning Safety .....	384
Transducer Cleaning and Disinfection Guidance ....	386

General Cleaning and Disinfection Procedures for the Aixplorer® Transducers .....	387
Cleaning and Disinfection Products .....	388
Soaking Limits .....	391
Additional Information Regarding Cleaning and Disinfection of Ultrasound Transducers .....	392
<b>10. Troubleshooting .....</b>	<b>393</b>
<b>11. Acoustic Output Detailed Reporting .....</b>	<b>397</b>
<b>Table of Symbols used in Acoustic Output Reporting .....</b>	<b>399</b>
<b>Detailed Acoustic Output Tables .....</b>	<b>400</b>
Acoustic Output Transducer/Mode Summary Table .....	400
Measurement Uncertainties .....	402
Acoustic Output Detailed Tables .....	402
<b>12. References .....</b>	<b>441</b>
<b>General References .....</b>	<b>443</b>
<b>Obstetrical References .....</b>	<b>448</b>
.....	448
<b>Index .....</b>	<b>567</b>
<b>13. NOTES .....</b>	<b>573</b>

# 1 Introduction



# Welcome!

Welcome and congratulations on your purchase of the Aixplorer® Ultrasound System.

The following documents are available for the Aixplorer® Ultrasound System:

- **Quick Guide**
- **User's Guide**

The Quick Guide contains basic information regarding the use of the product.

It does not replace the User's Guide.

This User's Guide contains important information regarding the use and safety of the product. Please read this guide carefully and store it in a location where it can be easily accessed.

The Aixplorer® system has been designed with the safety of the operator and patient in mind.

Please read the following chapters thoroughly before you start working with the system.

SuperSonic Imagine guarantees the system will perform as intended only when all cautions and warnings specified in this user's guide are observed.



# About this User's Guide

This user's guide contains important information about the use of your ultrasound system.

The features described in this user's guide may be optional. Please contact your local SuperSonic Imagine sales or service representative for further information.

Pictures are not contractual and are only displayed for general information purposes.

It also contains information about contacting SuperSonic Imagine for support.

This guide is intended for use by, or by the order of, and under direct supervision of a licensed physician qualified to direct the use of the ultrasound device.

This guide is intended for users who have been trained or are otherwise familiar with the use of medical ultrasound devices.

Clinical guidance on how to perform an ultrasound examination is not provided in this manual.

This user's guide complies with the following:

- 93/42/EEC European Directive modified by 2007/47/EEC European Directive
- FDA regulation, 21 CFR § 801.109



# About this Device

## General Description

The SuperSonic Imagine Aixplorer® system is a cart based ultrasound imaging system used to perform diagnostic general purpose ultrasound imaging studies.

The system contains a scan converter and can be coupled to a variety of linear, curved, micro-convex, and motorized linear array transducers to produce images, which are displayed on a LCD monitor.

An adjustable control panel with integrated touch screen allows the user to perform an ultrasound exam quickly and efficiently in accordance with ALARA principles.

The system also allows the user to perform measurements and associated calculations, capture images to digital memory or to an external device (such as a printer), and review diagnostic studies in the form of a report.

The system functions in a manner similar to existing devices and transducers for the imaging modes: B-Mode, M-mode, Color Doppler imaging, Pulsed Wave Doppler, Harmonic Imaging, Amplitude Power Doppler imaging, Directional Amplitude Power imaging, Contrast Imaging, Elasticity Imaging, and 3D imaging.

## Intended Use

The SuperSonic Imagine Aixplorer® ultrasound system is intended for general purpose pulse echo ultrasound imaging, Doppler fluid flow analysis of the human body, and tissue elasticity imaging of soft tissues.

## Indications for Use

The SuperSonic Imagine Aixplorer® ultrasound system is indicated for use in the following non-invasive diagnostic imaging applications: Abdominal, Small Organs, Musculoskeletal, Superficial Musculoskeletal, Vascular, Peripheral Vascular, OB-GYN, Pelvic, Pediatric, Neonatal Cephalic, Urology.

The SuperSonic Imagine Aixplorer® ultrasound system is indicated for use in the following invasive diagnostic imaging applications: Small Organs, Trans-rectal, Trans-vaginal, GYN, Pelvic, Urology, Vascular, and Brain<sup>1</sup>.

The system also provides the ability to measure anatomical structures (Abdominal, Small Organs, Musculoskeletal, Superficial Musculoskeletal, Peripheral Vascular, GYN, Pelvic, Pediatric, Urology, Trans-rectal, Trans-vaginal, Neonatal Cephalic, Fetal/Obstetrics).

This device is intended for use by, or by the order of, and under the supervision of a licensed physician qualified to use or direct the use of the device<sup>2</sup>.

This system should only be used by trained sonographers who are knowledgeable about the risk of excessive acoustic energy in the body, particularly in the case where a great amount of fluid is present in the scanning area.

## Contraindications

The Aixplorer® system is not designed for ophthalmic use or any use causing the acoustic beam to pass through the eye.

Using the system for procedures involving percutaneous umbilical blood sampling (PUBS) and in vitro fertilization (IVF) is not recommended by the manufacturer.

The Aixplorer® system is not intended for use in cardiac applications. The use of the Aixplorer® system with a defibrillator is prohibited.

---

<sup>1</sup>The Brain application is authorized in Europe only

<sup>2</sup>Information delivered by the device must be used by a licensed physician qualified to establish a diagnosis.

The Aixplorer® system is not intended for use with flammable anaesthetics or in conjunction with flammable agents.

## Prescription Device

Caution: United States federal law restricts the sale of diagnostic ultrasound devices to sale by or on the order of a physician<sup>2</sup>.

## Conformance Standards

According to 93/42/EEC European Directive modified by 2007/47/EEC European Directive, Aixplorer® is a Class IIa Medical Device.

According to :

- IEC/EN 60601-1, Equipment is Class I, type BF.
- IEC 60601-1-2, Equipment is Class A.

The product is compliant to the following standards:

- UL 60601-1 Medical Electrical Equipment, Part 1: General Requirements for Safety
- CAN/CSA-C22.2 No. 601.1 Medical Electrical Equipment - Part 1: General Requirements for Safety
- IEC/EN 60601-1-1 Medical electrical equipment – Part 1-1: General requirements for safety – Collateral standard: Safety requirements for medical electrical systems.
- IEC/EN 60601-1-2 Medical electrical equipment – Part 1-2: General requirements for safety – Collateral standard: Electromagnetic compatibility – Requirements and tests.
- IEC/EN 60601-1-4 Medical electrical equipment – Part 1-4: General requirements for safety – Collateral standard: Programmable electrical medical systems.
- IEC 60601-2-37 Medical electrical equipment – Part 2-37: Particular requirements for the safety of ultrasonic medical diagnostic and monitoring equipment.
- IEC 62304 Medical device software – Software life cycle processes

- NEMA UD 2 Acoustic Output Measurement Standard for Diagnostic Ultrasound Equipment
- NEMA UD 3 Standard for Real-Time Display of Thermal and Mechanical Acoustic Output Indices on Diagnostic Ultrasound Equipment
- EN ISO 10993-1 Biological evaluation of medical devices – Part 1: Evaluation and testing
- EN ISO 14971: Medical devices – Application of risk management to medical devices
- IEC/EN 60601-1 Medical electrical equipment – Part 1: General requirements for safety
- IEC 61340-5-1: Electrostatics – Part 5-1: Protection of electronics devices from electrostatic phenomena – General Requirements
- IEC 61340-5-2: Electrostatics – Part 5-2: Protection of electronics devices from electrostatic phenomena – User guide
- EN 50419: 2006 Marking of electrical and electronical equipment in accordance with Article 11(2) of Directive 2002/96/EC (WEEE)
- Digital Imaging and Communications in Medicine (DICOM) standard: PS 3 -2011

## Certifications

SuperSonic Imagine is ISO 13485 certified.

# Contact Us

Customer service representatives are available regionally to help answer your questions.

Please contact your local SuperSonic Imagine sales or service representative for assistance.

## France



### **SuperSonic Imagine**

510, rue René Descartes Bat F  
13857 Aix en Provence Cedex

Telephone: +33 (0)442 99 24 32

Telephone: +33 (0)426 70 02 70

Fax: +33 (0)442 52 59 21

E-mail: [contactsFR@supersonicimagine.com](mailto:contactsFR@supersonicimagine.com)

## North America



### **SuperSonic Imagine, Inc.**

11714 North Creek Parkway N - Suite 150  
WA 98011 Bothell - North America

Telephone: +1(425) 686 6380

Fax: +1(425) 686 6387

E-mail: [contactsUSA@supersonicimagine.com](mailto:contactsUSA@supersonicimagine.com)

## United Kingdom



### **SuperSonic Imagine Ltd.,**

18 Upper Walk

Virginia Water  
Surrey GU25 4SN - United Kingdom  
Telephone: +44 (0)845 643-4516  
E-mail: [contactsUK@supersonicimagine.com](mailto:contactsUK@supersonicimagine.com)

## Germany



**SuperSonic Imagine GmbH**  
Zeppelinstr. 71 – 73  
81669 München - Germany  
Phone: +49 89 36036 - 844  
Fax: + 49 89 36036 - 700  
E-mail: [contactsDE@supersonicimagine.com](mailto:contactsDE@supersonicimagine.com)

## China



**SuperSonic Imagine**  
Suite 2304, Block D, Ocean International, DongSiHuan ZhongLu,  
Chaoyang District, Beijing (100025), China  
Phone : +86-10- 85861023/ 2951/ 2917  
E-mail: [beijing@supersonicimagine.com](mailto:beijing@supersonicimagine.com)

## Service

Call your SuperSonic Imagine local representative.

# Service

The SuperSonic Imagine Aixplorer® ultrasound system is intended to provide many years of service.

The lifetime of the product is directly impacted by the following variables:

- Hours of clinical operational use of the product
- Hours of clinical non-operation use while the product is energized and in the “on” state
- Environmental exposure of the product with regard to temperature, humidity and pressure
- Appropriate electrical power conditions
- Proper handling and moving of the product
- Proper storage of the product when not in use
- Proper maintenance and cleaning of the product
- Quality of repairs
- Quality of accessories used with the device

The SuperSonic Imagine Aixplorer® ultrasound system has to be installed by an authorized SuperSonic Imagine sales or service representative.

To optimize operation and maximize the life of the product, we recommend having an annual maintenance performed by a SuperSonic Imagine authorized representative.

Maintenance and service contracts are available.

All repairs must be conducted by a SuperSonic Imagine authorized representative.

Maintenance operations as described in [Chapter 9, System Care & Maintenance \[377\]](#) can be performed by the user.

Improper installation, repair or maintenance will void any warranties associated with the product.

Please contact a SuperSonic Imagine sales or service representative for further information.

# Upgrades and Updates

Upgrades may be announced that consist of hardware or software improvements.

Updated user information will accompany those system upgrades.

Always verify that you are using the revision of this document appropriate for your product version.

To verify the correct version of the document for your system or to obtain the latest revision, contact your SuperSonic Imagine representative or local distributor.



# 2 Physical Overview



# Dimensions

**Width:** 61cm (24in)

**Height:**

- 169cm (66.5in), with monitor fully raised
- 131cm (51.5in), with monitor locked

**Depth:** 105cm (41.5in)

**Weight:** about 97kg (214 Lbs) without any accessories.

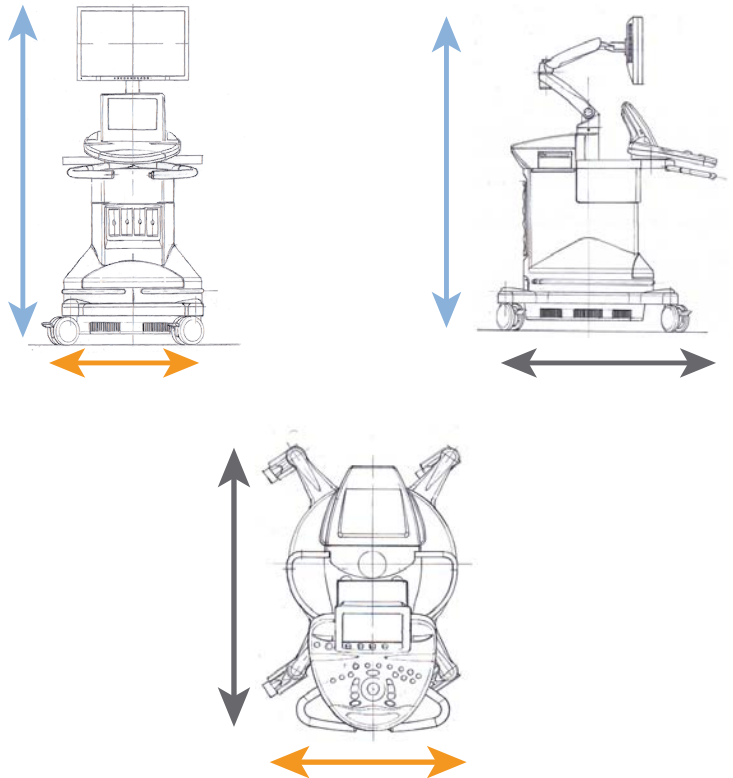

# Electrical Operating Requirements

The system contains an internal power supply which is designed to work at the following voltage ranges:

- 100 V ~, 50/60Hz, at 1500W,
- 110 - 120V ~, 50/60Hz, at 1500W
- or 220-240V~, 50/60Hz at 1500W.

Power must be available through a grounded, hospital-grade outlet (UL 60601-1).



# Input/Output Connectors

## USB Ports



### CAUTION

Externally powered USB devices powered are not permitted to be connected to the USB ports of the Aixplorer® ultrasound system.

Ethernet connectors must only be connected to IEC certified equipment.

Any USB device may be connected to the system as long as it is SELF-powered through the USB port (two USB ports can be used) or powered from an external supply IEC60601 compliant.



### WARNING

When using a USB port, ensure that both the user and the patient do not place hands or any other body parts on or in the USB port.

The following ports are available on the system:

- One USB port is located on the rear side of the control panel:



In this USB port, you can plug a memory stick.

- Two USB ports are located on the rear side of the system, above the air filters:



- One USB port is located between the two foot rests:



In this USB port, you can plug the footswitch.

A two-pedal KINESIS footswitch is provided with the Aixplorer® system (optional).

To connect the footswitch:

- Plug the USB cable into the USB port located between the two foot rests (see picture above).

- When the system is on, you can configure the function of the two pedals in the Setups (see [Chapter 8, Customizing the System \[337\]](#)).

## DVI Port

A DVI port is available on the rear of the system. The port supports connections of type DVI-D.



### CAUTION

Only equipments compliant with IEC 60601-1:2005 may be connected to the DVI socket.



An external monitor which supports DVI capability may be connected to this port.

For more information, see [the section called “Additional Video Devices” \[23\]](#) for more details.

## CD/DVD Drive

The CD Drive is located on the left side of the control panel:



To eject a CD/DVD:

1. Click on the appropriate icon (CD or DVD)
2. Follow the instructions that appear on the screen

For information on icons, refer to [the section called “Notification Icons” \[152\]](#).

If you need to manually eject the CD/DVD, insert one end of a paper clip in the hole located right next to the CD/DVD player.





# Printers

## Integrated Printers (optional)

A SONY black and white thermal printer is integrated on the system. It is located at the rear of the cart.

The SONY black and white thermal printer provided with the system should remain on.

It will stay in an energy-saving mode. Turning Off and restarting the printer stresses the Aixplorer® system and could cause other electrical problems.

## Additional Printer

You may want to plug an additional printer to your Aixplorer® device.



### **WARNING**

Never plug a printer that does not comply with IEC 60601-1 standard to a USB port of your Aixplorer®.

If the printer complies with the IEC 60950 standard, perform the following steps:

1. Make sure that the Aixplorer® device is connected to the network (the Ethernet port is located at the rear of the cart)
2. Plug the power cable of your external printer to the wall plug
3. Plug the network cable of your external printer to the network
4. Turn your external printer on
5. Configure the Aixplorer® system to connect to the printer on the same network





## **NOTE**

The Aixplorer® and the external printer may be plugged into the same network at your facility.

If the printer complies with the IEC 60601-1 standard, perform the following steps:

1. Plug the power cable of your external printer to the wall plug
2. Do one of the following, depending on the printer model:
  - connect the printer to Aixplorer® with the USB cable
  - connect the printer to Aixplorer® with the network cable

For the list of the recommended printers, please contact your Local SuperSonic Imagine representative.

# Additional Video Devices

You may want to attach an additional video device such as a LCD monitor or video projector to your Aixplorer® device.

The video output of the Aixplorer® is digital video, with a native resolution of 1920x1080.

You may connect video devices to the Aixplorer® which are compatible with the port type and support this video resolution.

If your external video device complies with the IEC60601-1:2005 and with these requirements, perform the following steps:

1. Power your external video device.
2. Be sure your external video device is powered ON, and it is set such that its input is specified to receive signals from the DVI connector. See the user's guide of the external video device for more details.
3. Connect your external video device to the Aixplorer® by means of a DVI cable, no longer than 5 m\* (15 ft\*) in length.
4. Turn on the power of the Aixplorer®. The main display will be mirrored on the system display and on the external monitor.

\*DVI cables of 5 m in length have been tested with Aixplorer®. Longer cables may cause digital signal degradation or loss.



## TROUBLESHOOTING NOTE

External video devices which do not support the resolution of 1920x1080 may result in the following:

1. No signal displayed on the external video device
2. A “letterbox” effect where the video display is shown with a black border around the edges.
3. An aspect ratio adjusted signal is displayed. This may result in the image being stretched or compressed to fit the display.

If you experience problems with the video quality or aspect ratio, it is most likely caused by external video devices which do not support the native resolution of 1920x1080. This can be resolved by adding

a “digital scaler” between the external monitor and the Aixplorer®. For more information, please contact your local SuperSonic Imagine representative.



## **CAUTION**

Additional equipment connected to medical electrical equipment must comply with the respective IEC or ISO standards (e.g. IEC 60950 for data processing equipment).

Furthermore all configurations shall comply with the requirements for medical electrical systems (see IEC 60601-1-1 or clause 16 of the 3rd Ed. of IEC 60601-1, respectively).

Any person connecting accessory equipment to medical electrical equipment is configuring a medical system and is therefore responsible that the system(s) complies with the requirements for medical electrical systems.

Attention is drawn to the fact that local laws take priority over the above mentioned requirements.

If in doubt, consult your local representative or the technical service department.

# Temperature, Pressure and Humidity Limits

The system should be operated, stored, and transported within the parameters outlined below.

Either its operational environment must be constantly maintained or the unit must be turned Off.

	Operational	Storage	Transport
Temperature	From 10°C to 35°C (From 50°F to 95°F)	From -20°C to 50°C (From -4°F to 122°F)	From -20°C to 50°C (From -4°F to 122°F)
Relative Humidity	From 30% to 80%	From 30% to 80%	From 30% to 80%
Pressure	From 525 mm Hg to 795 mm Hg	From 375 mm Hg to 795 mm Hg	From 375 mm Hg to 795 mm Hg
Altitude	Below 3000 m		

## Receiving and Storing Aixplorer®

Upon delivery and initial installation, please allow SuperSonic Imagine authorized personnel to open the system packaging. If you need to send the device back to SuperSonic Imagine for service, please do not pack it. Contact your Local SuperSonic Imagine representative.

The Aixplorer® system must be installed only by SuperSonic Imagine authorized personnel.

It is imperative to leave the system 48 hours at room temperature before it is first switched on.

## Storage of the Device

The Aixplorer® ultrasound system may be stored indefinitely provided that it is done so under ambient conditions which do not exceed the limits outlined in this chapter.

In the case of extremely long periods of storage (greater than 1 year), it is possible that on-board batteries may become discharged.

If you plan to store the system for extended periods of time, please consult your authorized SuperSonic Imagine service representative regarding battery removal prior to storage.

It is also prudent to have a service representative on-site when re-starting the system for the first time after prolonged storage.

## Safe Disposal of the Device

The Aixplorer® ultrasound system contains components that are similar to those found in a typical personal computer.

As such, the electronic parts contained within the housing may contain small amounts of lead (electrical components), mercury (electrical components and batteries) and lithium ions (batteries).

The housing is also composed of plastic material, which can be recycled. Please verify with your local regulations regarding recycling of electrical components, plastics and overall safe disposal of this device.

Please contact your SuperSonic Imagine representative for further information.

# 3 Safety





# Definition of Precaution Levels

The following symbols are used in this document:

A **WARNING** symbol describes precautions necessary to prevent injury or loss of life.



**WARNING**

A **CAUTION** symbol describes precautions necessary to protect the equipment.



















**CAUTION**

# Symbols

The following symbols are used on the ultrasound device.

Familiarize yourself with these symbols and the following related sections in this guide.

Symbol	Meaning
<b>General Controls</b>	
	On the power switch, represents system power ON and OFF
	On the control panel, represents system START and STOP
<b>Electricity and Electronics</b>	
	USB input/output port
	Ethernet connection
	Equipotentiality ground
	Isolated patient connection. Type BF
	Earth
	DVI out
<b>Other</b>	
	CE marking of conformity to 93/42/EEC European Directive modified by 2007/47/EEC European Directive
	Assure safe disposal of the device
	ESD sensitive component
 	Caution: Read the user's guide

Symbol	Meaning
	Do not push or pull the system from the side or from the monitor, or against an excessive resistance. The system could tip over.
	Do not sit on the system, including printer covers, control panel, or handles
	Manufacturer - Manufacturing date

# General Equipment Safety

Read this User's Guide carefully and get acquainted with the transducers and the ultrasound system before using them.



## WARNING

Do not remove system covers. Hazardous voltages are present inside the system.

To avoid electrical shock, use only the supplied power cords and connect to properly grounded wall receptacles.

Do not operate the system if a significant quantity (2 mL or greater, wet to the touch) of liquid (gel, water, saline, alcohol, blood, etc.) has penetrated the outer casing, including control panel.

Discontinue use of the device until the liquid is removed or completely dried.

Exercise caution when negotiating ramps and narrow hallways.

Keep hands and feet away from system wheels when moving or transporting the system.

Before performing maintenance or cleaning, always press the On/Standby switch to put the system into standby mode, set the power switch to Off, and then disconnect the system from the wall outlet.

Do not push the system from the side, or against an excessive resistance. The system could tip over.



## CAUTION

Repairs must be performed by authorized personnel only.

Repairs and maintenance performed by unauthorized parties are at the user's risk, and shall void all warranties, explicit or implied.

For optimal performance, the Aixplorer® system should be connected to an electrical circuit that is able to sustain at least 1500W.

To avoid interference, avoid operating the system in an environment where portable and mobile radio-frequency (RF) communications are in use.

Avoid handling fluids near the system. Fluids leaking through the air vents of the system may cause electrical failure.

Warm air will be exhausted from the rear, the sides and the bottom of the system. This is normal behavior when the system is in operation.

Do not block or obstruct air vents at the rear of the system.

Use the handle to move the system.

To prevent damage to system cables or transducer cables, be careful not to run over them with the machine.

Never attempt to open a transducer or a transducer connector.

Do not submerge the system cables or the transducer cables in liquid.

Ultrasound transducers are easily damaged when handled improperly. Avoid dropping the transducer or bringing it into contact with any sharp or abrasive surfaces or objects.

Improper cleaning or sterilization of the transducers may cause permanent damage. See [Chapter 9, System Care & Maintenance \[377\]](#).

The automatic Freeze feature will turn Off the acoustic output to the transducer when the system is not in use. This will help prevent heat build-up and damage to the transducer.

If an error message appears on the monitor indicating a hazardous condition exists, note the error code and turn Off the power to the system. Contact the SuperSonic Imagine Customer Service Department to relate and troubleshoot the problem.

Do not load the system with any peripheral devices or equipment weighing more than 20 lbs (10 kgs). Doing so may cause the system to become unstable and tip over.

If an excessive internal temperature is reached, the system displays a warning message and will eventually shut Off automatically.

# Electrical Safety

This device has been tested by a third-party testing agency and is described as a Class 1 electrical device with Type BF isolated patient applied parts.

This device has demonstrated conformance to the following standards:

- IEC 60601-1, UL 60601-1, CAN/CSA-C22.2 No. 601.1



## **WARNING**

Shock hazards may exist if this system is not properly grounded.

The system must be plugged into a fixed power socket that is grounded. The grounding wire must not be defective. Never use an adaptor or converter to connect with a power source plug (three- prong to two- prong converter).

Use only the cables provided by SuperSonic Imagine and connect these cables according to the installation process.

To avoid electrical shock and fire hazard, check power cables and plugs for damage on a regular basis.

Hazardous voltages exist inside the system; therefore, the protective covers on the system should not be removed. Any internal adjustment or replacement must be made by an authorized SuperSonic Imagine service representative.

To avoid risk of electrical shock hazards, always inspect the transducer before use. Make sure the face is not cracked, torn or chipped and that the housing of the transducer or the cord is not damaged.

Electrostatic discharge (ESD) or static shock is a natural phenomenon. Static shock is a discharge of electrical energy that can be transferred to file cabinets, computer equipment, metal door knobs and other individuals.

Static shock occurs most often during low humidity conditions that can be brought on by heating or air conditioning.

To avoid damage to the system or transducers resulting from an electrical energy discharge from a system user or patient, the use of anti-static mats, anti-static sprays or a ground wire connection between the system and the patient table are recommended.



## **CAUTION**

Use caution when plugging in or unplugging the system.

Do not touch transducer connector pins when plugging in or unplugging a transducer.

Do not insert any objects through openings in the system covers.

If a foreign object should fall into an opening in the system cover, immediately power down the system and discontinue use until the system can be inspected by an authorized service representative.

## **Electromagnetic Interference**

Medical electrical equipments need special precautions regarding EMC and need to be installed and put into service according to the EMC information. The Aixplorer® system must be installed only by SuperSonic Imagine authorized personnel. This equipment has been tested and found to comply within the limits for medical devices in IEC 60601-1-2 Class A. These limits are designed to provide reasonable protection against harmful interference in a typical medical institution. This equipment can radiate radio frequency energy, and if not installed and used in accordance with the instructions, may interfere with other devices in the vicinity. Powering the system Off and On can determine if the problem is caused by this unit. In addition, electromagnetic fields from fixed transmitters such as base stations for radio (cellular/cordless) telephones and land mobile radios, amateur radio, AM and FM radio broadcast, and TV broadcast may interfere with the use of this device. Portable and mobile RF communications equipment can affect the device. These fields may cause degradation of the image quality of the device. Sources of electromagnetic interference cannot be predicted theoretically with accuracy.

If this system causes harmful interference to other devices, or the system demonstrates an interference pattern on the image, the user is encouraged to try to correct the interference by:

- Increasing the distance separating the pieces of equipment
- Ensuring the system is not connected to the same outlet as the other device(s)
- Using only shielded cabling when connecting the device to networks and peripherals
- Reorienting the device
- Consulting the manufacturer or field service representative for help

If abnormal performance persists, additional measures may be necessary, such as relocating the system.



# Recommended Separation Distances Between Portable and Mobile RF Communications Equipment and Aixplorer

The Aixplorer® is intended for use in an electromagnetic environment in which radiated RF disturbances are controlled. The customer or the user of the Aixplorer® can help prevent electromagnetic interference by maintaining a minimum distance between portable and mobile RF communications equipment (transmitters) and the Aixplorer® as recommended below, according to the maximum output power of the communications equipment.

Rated maximum output power of transmitter w	Separation distance according to frequency of transmitter m		
	150 kHz to 80 MHz $d = 35\sqrt{P}$	80 MHz to 800 MHz $d = 1.2\sqrt{P}$	800 MHz to 2,5 GHz $d = 2.3\sqrt{P}$
0.01	3.5	0.12	0.23
0.1	11	0.40	0.73
1	35	1.2	2.3
10	111	3.8	7.3
100	350	12	23

For transmitters rated at a maximum output power not listed above, the recommended separation distance  $d$  in meters (m) can be estimated using the equation applicable to the frequency of the transmitter, where  $P$  is the maximum output power rating of the transmitter in watts (W) according to the transmitter manufacturer.

NOTE 1 At 80 MHz and 800 MHz, the separation distance for the higher frequency range applies.

NOTE 2 These guidelines may not apply in all situations. Electromagnetic propagation is affected by absorption and reflection from structures, objects and people.



## WARNING

This equipment/system is intended for use by healthcare professionals only.

This equipment/system may cause radio interference or may disrupt the operation of nearby equipment.

It may be necessary to take mitigation measures, such as re-orienting or relocating Aixplorer® or shielding the location.



## CAUTION

Use of this system in the presence of an electromagnetic field can cause the equipment to perform outside of the published performances.

Avoid using cellular phones, pagers, radios, TVs, or microwave transmission equipment near the machine.

The use of cables, transducers, and accessories other than those supplied with the product may result in increased emissions from the system.

Do not touch transducer connector pins when plugging in or unplugging a transducer.

Do not connect transducers to the system unless ESD precautionary procedures are used.

Aixplorer® is provided with the following cables:

Cable Type	Length
Power Supply Cable	3m
Probe Cables	2.10m
Ethernet Cable	5m

Aixplorer® has been EMC tested with the following accessories:

- SONY UP-D711MD Black and white printer (integrated)
- SONY UP-D25MD Color printer and its printer bay
- SuperSonic Imagine SL15-4 probe
- SuperSonic Imagine SC6-1 probe
- SuperSonic Imagine SE12-3 probe
- SuperSonic Imagine SLV16-5 probe
- SuperSonic Imagine SL10-2 probe
- SuperSonic Imagine SMC12-3 probe

- Ethernet cable, CAT6a SFTP (PIMF) 500Mhz (shielded) AWG26/7, meets standards EIA/TIA 568 B2- ISO/IEC11801, maximum length 5 meters
- Foot switch



## **WARNING**

Using accessories and cables other than those listed above may result in increased emissions or decreased immunity of the system.

## Declaration of Electromagnetic Emissions

Aixplorer® is suitable for use in the following environment. The user must assure that it is used only in the electromagnetic environment as specified.

Emission Test	Compliance	Electromagnetic environment - guidance
RF Emission CISPR 11	Group 1	Aixplorer® uses RF energy only for its internal function. Therefore, its RF emissions are very low and are not likely to cause any interference in nearby electronic equipment.
RF Emission CISPR 11	Class A	Aixplorer® is suitable for use in all establishments other than domestic and those directly connected to the public low-voltage power supply network that supplies buildings used for domestic purposes.
Harmonic emission IEC 61000-3-2	Class A	
Voltage fluctuation/Flicker emissions IEC 61000-3-3	Complies	



### WARNING

Aixplorer® with its peripherals should not be used adjacent to or stacked with other electrical equipment.

If the use of adjacent or stacked electrical equipment is necessary, verify the normal operation of Aixplorer® and its peripherals.

## Declaration of Immunity

Guidance and manufacturer's declaration - electromagnetic immunity			
Aixplorer® is suitable for use in the following environment. The user must assure that the system is used according to the specified guidance and only in the electromagnetic environment listed in the electromagnetic environment as specified.			
Immunity Test	IEC 60601 Test	Compliance Level	Electromagnetic Environment Guidance
Conducted RF IEC 61000-4-6 Radiated RF IEC 61000-4-3	3 Vrms 150 kHz to 80 MHz 3 V/m 80 MHz to 2,5 GHz	0.10 Vrms 3.0 V/m	<p>Portable and mobile RF communications equipment should be used no closer to any part of Aixplorer®, including cables, than the recommended separation distance calculated from the equation applicable to the frequency of the transmitter.</p> <p>Recommended separation distance</p> $d = 35 \sqrt{P}$ $d = 1.2 \sqrt{P} \quad 80 \text{ MHz to } 800 \text{ MHz}$ $d = 2.3 \sqrt{P} \quad 800 \text{ MHz to } 2,5 \text{ GHz}$ <p>where P is the maximum output power rating of the transmitter in watts (W) according to the transmitter manufacturer and d is the recommended separation distance in meters (m).</p> <p>Interference may occur in the vicinity of equipment marked with the following symbol:</p> 

NOTE 1 At 80 MHz and 800 MHz, the higher frequency range applies

NOTE 2 These guidelines may not apply in all situations. Electromagnetic propagation is affected by absorption and reflection from structures, objects and people.

a) Field strengths from fixed transmitters, such as base stations for radio (cellular/cordless) telephones and land mobile radios, amateur radio, AM and FM radio broadcast and TV broadcast cannot be predicted theoretically with accuracy. To assess the electromagnetic environment due to fixed RF transmitters, an electromagnetic site survey should

be considered. If the measured field strength in the location in which Aixplorer® is used exceeds the applicable RF compliance level above, Aixplorer® should be observed to verify normal operation. If abnormal performance is observed, additional measures may be necessary, such as re-orienting or relocating the Aixplorer®.

b) Over the frequency range 150 kHz to 80 MHz, field strengths should be less than [VI] V/m.

Immunity Test	IEC 60601 Test Level	Compliance Level	Electromagnetic Environment Guidance
Electrostatic discharge (ESD) IEC 61000-4-2	±6 kV contact ±8 kV air	± 4 kV contact ± 8 kV air	Floors shall be wood, concrete or ceramic tile. If floors are covered with synthetic material, the relative humidity shall be at least 30 %
Electrical fast transient/burst IEC 61000-4-4	±2 kV for power supply line ±1 kV for input/output lines	±2 kV for power supply line ±1 kV for input/output lines	Main power quality shall be that of a typical commercial or hospital environment.
Surge IEC 61000-4-5	±1 kV differential mode ±2 kV common mode	±1 kV differential mode ±2 kV common mode	Main power quality should be that of a typical commercial or hospital environment.
Voltage dips, short interruptions and voltage variations on power supply input line IEC 61000-4-11	<5 % UT (>95% dip in UT) for 0.5 cycle 40 % UT (60% dip in UT) for 5 cycles 70 % UT (30% dip in UT) for 25 cycles <5 % UT (>95 % dip in UT) for 5 sec	<5 % UT (>95% dip in UT) for 0.5 cycle 40 % UT (60% dip in UT) for 5 cycles 70 % UT (30% dip in UT) for 25 cycles <5 % UT (>95 % dip in UT) for 5 sec	Main power quality should be that of a typical commercial or hospital environment. If the user of the Aixplorer® requires continued operation during power mains interruptions, it is recommended that the Aixplorer® be powered from an uninterruptible
<b>NOTE : UT is the a.c. main voltage prior to application of the test level.</b>			

Immunity Test	IEC 60601 Test Level	Compliance Level	Electromagnetic Environment Guidance
			power supply or a battery.
Power frequency (50/60Hz ) Magnetic field IEC 61000-4-8	3 A/m	3 A/m	Power frequency magnetic fields should be at levels characteristic of a typical location in a typical commercial or hospital environment.
<b>NOTE : UT is the a.c. main voltage prior to application of the test level.</b>			

# Thermal Safety

Our device has been designed to have a surface temperature not exceeding 50°C in air and 43°C when in contact with the patient or user when measured under the requirements of the IEC 60601-2-37 standard. Some heat is generated by the ultrasound system, and by the transducer. Heat generated by the electrical components of the ultrasound system is dissipated through specific outlets. Heat may also be generated at the surface of the ultrasound transducer. In some cases the heat of the transducer may be detected at the surface of the skin. This would occur if the transducer remains in contact with a part of the body for a prolonged period of time. The ultrasound system has been equipped with internal sensors which monitor the temperature rise within the chassis. Alarms and WARNING messages may be displayed on the system in the event of an overheating condition. In the case of extreme or prolonged heat build-up, the system may automatically shut-down. If heating of either the transducer or system is determined to be a problem, please call your SuperSonic Imagine service representative immediately.



## **WARNING**

Ultrasound system overheating may occur if the environment exceeds the recommended ambient operating conditions.

To avoid overheating, be sure the system is operated under normal “room temperature” conditions, and adequate ventilation is provided.

Ultrasound can produce harmful effects in tissue and potentially result in patient injury.

Always minimize exposure time and keep ultrasound levels low when there is no medical benefit (ALARA principle).

A system which is overheating due to external conditions or an internal fault may issue a warning followed by a spontaneous shut-down to prevent heat damage or fire. If this occurs, discontinue use of the system and call your SuperSonic Imagine service representative.

Transducer surfaces may experience heat-build up. This is especially true if the transducer is in prolonged use and/or the point of contact with the body is stationary.



Please use ALARA principles to prevent unnecessary heating of the patient or the transducer.

Using the “Freeze” control is recommended to suspend acoustic energy to the transducer when not in use.

Do not maintain the transducer in one position on the body for prolonged periods of time. Prolonged exposure can produce minor burns.



## **CAUTION**

Do not operate the system if ambient temperature is above the recommended limit.

Use caution when operating the system in small spaces. Ambient room temperature increases may occur.

Change or clean air filters regularly to prevent system overheating.

The ultrasound system is designed to auto-Freeze if the imaging controls are not changed for a duration defined by the user. This is designed to reduce heat build-up of the transducer. Use the Freeze button to resume scanning.

If a system persistently issues an operating temperature-related warning, discontinue use of the system and call your SuperSonic Imagine service representative.

If the system reaches a certain temperature, follow the instructions that appear on the screen.

## **Mechanical Safety**

The ultrasound system has been ergonomically and mechanically optimized to be pleasant, efficient and safe, provided that it is used as intended and all instructions, warnings and cautions specified in this User’s Guide are followed.

If the system suffers mechanical damage, discontinue use and call an authorized SuperSonic Imagine representative for assistance.



## **WARNING**

Do not use the system if any of the exterior covers are cracked, damaged, missing or improperly installed.

Touching internal electrical or mechanical parts may cause injury or death.

If a foreign object should fall into an opening in the system cover, immediately power down the system and discontinue use until the system can be inspected by an authorized service representative.

Do not push or pull the system from the side or from the monitor, or against an excessive resistance. The system could tip over.



## **CAUTION**

Use caution when accessing the peripheral bays.

Use caution when accessing cables on the back of the system. Some mechanical exterior parts may cause abrasion.

If the system does not roll smoothly on its wheels, do not force the system to move.

Do not load the system with any peripheral devices or equipment weighing more than 20 lbs (10kgs). Doing so may cause the system to become unstable and tip over.

To prevent damage to system cables or transducer cables, be careful not to run over them with the machine.

Never attempt to open a transducer or a transducer connector.

Do not submerge the system cables or the transducer cables in liquid.

# Safely Performing Ultrasound Examinations with the SuperSonic Imagine Aixplorer® System

## Bioeffects and Biophysics of Ultrasound Interactions

### Frequencies and Energy Levels of Ultrasound Waves

Ultrasound is sound at a very high frequency above human hearing, i.e. above 20 kiloHertz (kHz). For medical diagnostic purposes, ultrasound systems generate ultrasound waves typically ranging from 1 to 20 MegaHertz (MHz). A probe, or transducer, is applied on the patient's body. It emits ultrasound waves that pass into the body, then reflect off the different tissue boundaries. The transducer then receives these reflections, which are assembled and processed by a computer system to generate a picture displayed on a video monitor. Key parameters of the ultrasound waves can vary, such as their frequency, density, focusing and aperture. For example, beams at higher frequencies produce higher resolution images but cannot penetrate as deeply into the body as lower frequencies, which penetrate more deeply but show lower resolution. Therefore, the choice of frequency is a trade-off between spatial resolution of the image and imaging depth. Energy levels of ultrasound waves are measured in  $\text{W}/\text{cm}^2$ . The two typical values that are calculated and taken into account are the spatial-peak temporal average intensity ( $I_{\text{SPTA}}$ ), measured in  $\text{mW}/\text{cm}^2$  and of the spatial-peak pulse average intensity ( $I_{\text{SPPA}}$ ), measured in  $\text{W}/\text{cm}^2$ . Diagnostic ultrasound systems usually use energy levels corresponding to an  $I_{\text{SPTA}}$  ranging between 0 and 720  $\text{mW}/\text{cm}^2$ .

## **Change in Policy and Operator Education**

The first guidelines and recommendations ever published for ultrasound manufacturers was proposed by the American Institute of Ultrasound in Medicine (AIUM) in 1983. These guidelines were revised in 1988 where the energy maximum limit was fixed to 100 mW/cm<sup>2</sup>. Below this limit, no adverse bioeffects had ever been reported on animals or patients, although contradictory observations have been reported later, in 1993. Since 1993, the Food and Drug Administration (FDA) imposed a maximum limit on the acoustic output of ultrasound devices. However, due to the continuous development of sophisticated systems with improved image quality and diagnostic sensitivity, it was realized that safely increasing the limit under specific circumstances could bring diagnostic advantages (i.e., patients with fatty tissues). In 1997, the FDA increased the maximum limit of energy output level up to a much higher value (see section Present state of output levels) and recognized an increased role of the operator in limiting the potential for ultrasound bioeffects. In conclusion the operator has the responsibility of making an informed decision concerning the desired diagnostic information in comparison to possible adverse bioeffects. Achieving this goal requires an adapted education that needs to be provided to every operator in order to make an informed and balanced decision. In this context, the AIUM document published in 1994, "Medical Ultrasound Safety", is highly recommended, as is this particular educational content.

## **Ultrasound Use: History and Safety Record**

Ultrasound really started to be used in clinical medicine in the 1950's. It has always been considered as a potential medical imaging technique despite continuing concerns of potential related risks: from the beginning, some studies demonstrated that sufficient ultrasound levels could harm biological material, even with lower doses than used today. Due to the absence of adverse effects reported on patients, the diagnostic ultrasound technology kept on being developed and improved, culminating in the mid-1980's with grayscale and real-time imaging modes. In parallel, the ability to quantify ultrasonic fields also improved considerably, thus giving a tool to measure accurately ultrasound energy levels. Diagnostic ultrasound imaging has accumulated an excellent safety record over the

past 50 years. The recent development of new applications and new modes and the increase in ultrasound use have not impacted on this safety record. However, ultrasound safety continues to be discussed and regulatory authorities are continuously revising the guidelines and standards in order to minimize potential risks and maintain a safe framework for patients, manufacturers and users.

## Potential Hazards at High Output Levels

The first deleterious effects of ultrasound were observed by Paul Langevin in 1917: “fishes placed in the beam in the neighborhood of the source operation in a small tank were killed immediately, and certain observers experienced a painful sensation on plunging the hand in this region”. In 1930, Harvey released the first review paper on biological effects of ultrasound: he reported on the physical, chemical, and biological effects in which alterations were produced in macromolecules, micro-organisms, cells, isolated cells, bacteria, tissues, and organs with a view towards the identification of the interaction mechanisms. In the mid 1990’s, an animal study observed lung and intestine hemorrhage with a pulsed, 2 MHz ultrasound exposure for 3 minutes, although this observation was not confirmed intraoperatively with transesophageal echocardiography.

Here are some examples of possible deleterious bioeffects of ultrasound:

- Cells of the sensory organs (eye, ear, nervous tissue) are particularly sensitive to ultrasound and can be destroyed by thermal effect.
- Cavitation mechanisms can create tearing lesions of the inner layer of blood vessels, thus leading to thrombogenic processes.
- Cell lysis has been observed in vitro with 1 MHz continuous ultrasound exposure, due to cavitation.
- Cardiac premature contractions have been observed in frogs with 1.2 MHz exposure to a single 5-millisecond pulse with normal recovery.
- The development of blood cells has been reported to be altered in monkeys after multiple exposures to ultrasound at diagnostic levels.

Moreover, potential bioeffects of ultrasound at the subcellular level may lead to structural and functional changes in cell membranes, thus affecting signal transduction, for example.

# Mechanisms for Thermal and Non-Thermal Bioeffects

Ultrasound can cause heating of the tissues (thermal effect) and can create non-thermal effects (mechanical effects).

## THERMAL EFFECTS

An ultrasonic wave propagating into a biological tissue is attenuated with distance from its emission source, due to scattering (redirection of the ultrasound beam) and/or absorption (conversion into heat). Depending on the tissue characteristics, a temperature increase will occur if the rate of heating is greater than the rate of cooling the tissue. Operators must be aware of that risk, which may counterbalance the benefits of ultrasound examination.

## NON-THERMAL OR MECHANICAL EFFECTS

Non-thermal effects include cavitation, production of audible sounds, movement of cells in liquid, electrical changes in cell membranes, shrinking and expansion of bubbles in liquid, and pressure changes. Cavitation has been extensively studied: it happens when bubbles located in an ultrasound field start to resonate. This effect has not been demonstrated in human tissue; some observations of haemorrhagia have only been made in lung or intestine of laboratory animals. Other non-thermal effects caused by ultrasound include changes in pressure, force, torque (causing tissues to rotate) and streaming. Audible sounds and electrical changes of cell membranes can derive from such changes, potentially causing cell damage. Consequences of non-thermal bioeffects can cause damage to the tissue, eventually cell death, cell membrane disruption or ruptures of small blood vessels. Although these bioeffects have not been observed in humans, they could potentially occur with future technology.

## EXPOSURE-EFFECT STUDIES

The bioeffects of ultrasound on fetuses have always been of concern, due to the presence of developing tissues. This has become even more

present due to new ultrasound modalities arising in the late 1980's (harmonic imaging, color Doppler and 3D imaging) that have allowed new diagnostic capabilities. Since these methods potentially required more ultrasound energy, the FDA revised its diagnostic ultrasound regulatory guidelines in the early 1990's. As a result, the upper limit of output intensity allowed in fetal examinations has been raised more than 7 times its original value. Some concerns have arisen about the new regulations and researchers conducted epidemiological studies looking for associations between ultrasound exposure and newborn defects linked to fetal development. As reviewed by the National Council on Radiation Protection and Measurements (NCRP), one of the largest studies followed 15,000 women in Australia, but was not designed to study birth defects. Therefore, the lack of increase in birth defects was reassuring but not conclusive. Another large Canadian study focused on the correlation between ultrasound screening and prematurity. It concluded that the group receiving more ultrasound scans during pregnancy had slightly lower birth weights. The interpretation of epidemiological studies, however, can be biased by the prescription of ultrasound due to a suspected fetal problem. Additionally, the NCRP has stated that there is insufficient evidence to conclude that diagnostic ultrasound is the cause of adverse effects such as low birth weight, or any adverse effect whatsoever. However, this conclusion does not preclude the possibility of any effect. Research is limited because physicians cannot perform more stringent experiments on their patients. As a preliminary mandatory step, more animal studies are recommended by the NCRP.

## **Risk Versus Benefit**

Diagnostic ultrasound systems provide diagnostic information that creates a clear benefit to the patient, to the physician, and to healthcare systems. Currently available systems give very good quality images and highly relevant information that allow physicians to make optimal decisions.

Ultrasound imaging is a favorite imaging technique because:

- It appears to be safe,
- It is known to provide diagnostic information with great sensitivity and specificity,
- It is widely accepted by patients,

- It has low costs when compared to other radiological modalities.

However, there are risks in doing or not doing an ultrasound exam:

On the one hand, performing an ultrasound examination may expose the patient to potential adverse bioeffects by heating or cavitation, although no such incidents have ever been reported on humans at diagnostic ultrasound levels. Physicians must also weigh the expected benefit against the potential risks of the ultrasound exam. They must balance the intensity and energy that is used to perform the exam against the beneficial information it brings. Increasing the intensity, the exposure time, focal properties, and the pressure are associated with an increased risk of bioeffects. However, using a low intensity may lead to poor diagnostic information.

On the other hand, not doing an ultrasound examination may prevent physicians and patients from getting relevant diagnostic information, or may lead to the acquisition of the same information through other modalities, which may be more invasive or require exposure to ionizing radiation. There currently should be no hesitation when choosing to perform an ultrasound examination when a significant clinical benefit is expected. For example, cardiac ultrasound examinations with transesophageal echocardiography give the ability to image the structure and function of the heart and great vessels, and allow the operator to follow the course of blood flow within the heart. In obstetrics, the National Institute of Health consensus development conference held in the early 1980's recommended not to perform routine ultrasound examination, but identified a number of appropriate clinical indications for the use of ultrasound imaging during pregnancy.

*"Diagnostic ultrasound has been in use since the late 1950s. Given its known benefits and recognized efficacy for medical diagnosis, including use during human pregnancy, the American Institute of Ultrasound in Medicine herein addresses the clinical safety of such use: No confirmed biological effects on patients or instrument operators caused by exposure at intensities typical of present diagnostic ultrasound instruments have ever been reported. Although the possibility exists that such biological effects may be identified in the future, current data indicate that the benefits to patients of the prudent use of diagnostic ultrasound outweigh the risks, if any, that may be present."*



## PRESENT STATE OF OUTPUT LEVELS

Since the adoption of the Output Display Standard (ODS) in 1992 and the publication of the revised FDA guidelines in September 1997, diagnostic ultrasound systems that follow the Output Display Standard, including fetal Doppler applications (except fetal heart rate monitors), must have a maximum energy level that is not application-specific. Therefore, the maximum energy level is currently defined by (1) a derated  $I_{SPTA}$  limit of 720 mW/cm<sup>2</sup> and (2) a maximum MI of 1.9 or a derated  $I_{SPPA}$  of 190 W/cm<sup>2</sup>. The only application-specific exception to these guidelines is the ophthalmic use with lower maximum values. When compared to the maximum application-specific limits that were decided and published in 1985 and 1987 as shown in the tables below, the actual maximum values available on today's systems have become much higher.

*Table 3.1. FDA's pre-amendments levels of diagnostic ultrasound devices (FDA, 1985)*

	Derated Intensity Values		
	$I_{SPTA}$ (mW/cm <sup>2</sup> )	$I_{SPPA}$ (W/cm <sup>2</sup> )	$I_m$ (W/cm <sup>2</sup> )
Cardiac	430	65	160
Peripheral Vessel and other*	720	65	160
Ophthalmic	17	28	50
Fetal Imaging	46	65	160

\* Abdominal, Intraoperative, Small Organ (breast, thyroid, testes), Neonatal Cephalic, Adult Cephalic

*Table 3.2. FDA's pre-amendments levels of diagnostic ultrasound devices (FDA, 1987).*

	Derated Intensity Values		
	$I_{SPTA}$ (mW/cm <sup>2</sup> )	$I_{SPPA}$ (W/cm <sup>2</sup> )	$I_m$ (W/cm <sup>2</sup> )
Cardiac	430	190	310
Peripheral Vessel and other*	720	190	310
Ophthalmic	17	28	50
Fetal Imaging	94	190	310

\* Abdominal, Intraoperative, Small Organ (breast, thyroid, testes), Neonatal Cephalic, Adult Cephalic

However, with the publication of the ODS in 1992, the ultrasound users have been given the ability to operate their systems with real-time information on the potential risk of biological effects within the tissue. The real-time information consists of two biophysical indices known as the Thermal Index (potential risk for temperature increase) and the Mechanical Index (potential risk for mechanical tissue damage). This has allowed operators to make appropriate and informed clinical decisions, to weigh risks versus benefits, and to implement the “As Low As Reasonably Achievable” (a.k.a. ALARA) principle.

## **Proposed Indices as Indicators of Thermal and Mechanical Effects**

### THERMAL INDEX

The Thermal Index (TI) estimates the temperature increase within the insonified tissue; its value derives from the ratio of the total acoustic power to the acoustic power required to raise the tissue temperature by 1°C. Every type of tissue has different absorption characteristics, and therefore a different absorption coefficient, which is directly proportional to the ultrasound wave frequency: the higher the frequency, the greater the absorption and the lower the depth penetration. Thus, optimizing the image penetration should take into account the increased risk of a temperature rise in the tissue. Because various tissues (blood, amniotic fluid, cerebrospinal fluid, urine, soft tissue, and bone) have different absorption capabilities and coefficients, some devices further subcategorize the TI according to the nature of the insonified tissue: soft tissue thermal index (TIS) for soft homogeneous tissues, cranial bone thermal index (TIC) for bone at or near the surface, and bone thermal index (TIB) for bone after the beam has passed through soft tissue. Bone has a very high absorption coefficient. Biological liquids such as amniotic fluid, blood, cerebrospinal fluid, and urine have an absorption coefficient of zero and therefore show minimal temperature rise. Soft tissue has an absorption coefficient that falls somewhere between fluid and bone.

## MECHANICAL INDEX

The mechanical or non-thermal effects of ultrasound absorption are estimated by a relative measure: the Mechanical Index (MI). It is calculated by dividing the spatial-peak value of the peak rarefactional pressure (rated by 0.3 dB/cm-MHz at each point along the beam axis) by the square root of the center frequency. As described above, the mechanical effects are the result of compression and decompression in the tissue and the formation of microbubbles (cavitation). This phenomenon is related to the peak negative pressure during a pulse, which is related to the pulse-average intensity. Therefore, the spatial-peak pulse-average intensity ( $I_{SPPA}$ ) is related to cavitation. Many ultrasound products use  $I_{SPPA}$  for specifications and therefore, operator awareness is a necessity. Current standards recommend that if an ultrasound device is capable of achieving a TI or MI of greater than 1.0, then the output display screen must show the appropriate index value for the operator to predict the potential for adverse bioeffects.

# Thermal Mechanisms

## Thermal Bioeffects

As introduced in the previous section, the absorption of ultrasound energy by biological tissues can produce heating. The self-heating of the probe may also contribute to heating in tissue. The mechanism of thermal bioeffects is well understood and can be estimated for different exposure conditions. However, even if some studies in mammalian tissue demonstrate that some aspects of the theory are reasonably well understood, many unanswered concerns still remain in terms of being able to assess in vivo temperature increase.

The rate of heat generation per unit volume is directly proportional to:

- the ultrasonic temporal-average intensity, which is itself proportional to the pressure amplitude and inversely proportional to the density of the medium
- the ultrasonic amplitude absorption, which increases with the increasing frequency

If damage occurs during exposure of tissue to elevated temperature, the extent of damage will be dependent upon the duration of the exposure as well as on the temperature increase achieved. Detrimental effects in vitro are generally noted at temperatures of 39–43°C, if maintained for a sufficient time period. At higher temperatures (>44°C) coagulation of proteins can occur. These effects have been documented in experimental studies of heat-induced cell death in cell cultures. Ultrasound machine operators must be particularly aware that risks may offset the benefits of ultrasound exposures when the temperature rise at the focal point of the ultrasound beam is calculated to be, for example in fetus echographic studies, more than 3°C for ten minutes or more. In Aixplorer®, the temperature is calculated according to the Standard for real-Time Display of Thermal and Mechanical Acoustic Output Indices on Diagnostic Ultrasound Equipment, NEMA UD3-2004 (refer to the section "Meaning of the TI and MI and Relation with Bioeffects"). However, threshold-based data suggest that for non-fetal soft tissue, and for scanning conditions consistent with conventional B-mode ultrasound exams for which the exposure durations at the same in situ location would be less than a few seconds, the allowable maximum temperature increase could be relaxed relative to longer exposures.

*Table 3.3. Temperature thresholds for biological risks on embryonic and adult tissues*

Thermal threshold	Temperature (°C)	Biological risk
Physiological level	37.0	safe region
Embryonic tissues	39.5	risks for obstetrics and pediatrics
Adult tissues	41.0	general risks

## Tissue Factors Influencing Ultrasound Thermal Effects

Ultrasonic waves propagating into biological tissues are attenuated due to the properties of the tissue. This attenuation is due to either absorption (portion of the wave energy that is converted into heat) or scattering (portion of the wave energy which changes direction). The higher the absorption, the higher the potential risk of rise of temperature within the tissue. Furthermore, as explained above, tissues with poor vascularization, (eye, tendon, fat) and tissues that conduct the heat (bone), are subject to higher temperature rises.

## Technical and Exposure Factors Influencing Ultrasound Thermal Bioeffects

Several technical factors also affect the temperature rise in the insonified tissue:

- Frequency of the ultrasound wave

Tissue heating depends on the absorption of ultrasound; absorption depends on the frequency of the ultrasound wave received. Therefore, heating in tissues will increase as the frequency of the ultrasound wave increases.

- Beam focusing

It improves the image resolution but it also increases the intensity and the potential of a temperature rise.

- Type of ultrasound wave form (pulsed or continuous waveforms)

Pulsed waves usually produce less heat than continuously emitted waves. The spatial-peak temporal-average intensity (ISPTA) is defined as the intensity at the maximum temporal-average intensity.

Other factors include pulse duration, pulse repetition frequency and beam/scanning configuration. The duty cycle is the product of the pulse duration and pulse repetition frequency. The heating in tissue is proportional to the duty cycle.

- Exposed tissue volume

Scanned modes (B-mode and color flow Doppler) allow a greater volume of tissue exposed to the ultrasound energy; this decreases the risk of heating. Unscanned modes (M-mode and spectral Doppler) use a stationary beam over a narrower volume of tissue; these modes show a higher risk of heating in tissues. The greatest temperature rise occurs between the focal point and the surface, the exact location of the “hottest point” depending on tissue attenuation, absorption, and the focal depth.

- Duration of ultrasound exposure

Temperature is affected by energy absorption during ultrasound exposure. The longer the tissue is exposed, the greater the absorption, thus the greater the risk for potential heating.

## THERMAL DOSE CONCEPT

An immediate consequence of a temperature increase is an increase in biochemical reaction rates. Most enzymes have their biological activity increased by a factor 3 for each 10°C temperature increase. However, they become denatured over 39°C, and deleterious effects are seen in vitro at temperatures ranging from 39 to 43°C, if exposure lasts a sufficient time. The concept of thermal dose describes the dependence between the duration of exposure and the increase of temperature. In biological tissues, the temperature of 43°C has been found to be a

transition threshold temperature, which serves as a reference, units of thermal dose being “equivalent minutes at 43°C”. Practically every increase of 1°C above 43°C halves the equivalent time, while every decrease of 1°C below 43°C results in a 4-fold equivalent time.

## BIOLOGICALLY SENSITIVE SITES

All biological tissues are sensitive to temperature, which can have deleterious irreversible effects. The fetus and the lens of the eye are two examples of some tissues that are more sensitive. During pregnancy, the fetus can absorb higher temperature elevation than its mother's surrounding tissue. Also, the ongoing ossification that occurs during the first trimester can lead to alteration of brain tissue by heat conduction within the neonatal skull. The 1998 recommendations from the World Federation of Ultrasound in Medicine and Biology (WFUMB) with regard to ultrasound-induced temperature elevation are as follows:

1. A diagnostic ultrasound exposure that produces a maximum in situ temperature rise of no more than 1.5°C above normal physiological levels (37°C) may be used clinically without reservation on thermal grounds.
2. A diagnostic ultrasound exposure that elevates embryonic and fetal in situ temperature above 41°C (4°C above normal temperature) for 5 min or more should be considered potentially hazardous.
3. The risk of adverse effects is increased with the duration of exposure.

## ABSORPTION

The volume rate of heat generation due to absorption is proportional to the acoustic intensity and absorption at a single frequency. After the initial propagation, the heat diffuses slowly into the tissue, expands, smoothes out, and diminishes from the original pattern. Tissue properties influence the temperature rise induced by ultrasound energy in the way the absorption of heat is directly affected by the protein proportion tissue contains (collagen has particularly high absorption capabilities). In most of the clinical situations, bone tissues have the greatest absorption coefficient, skin and tendon have intermediate absorption capabilities, brain, liver and kidney have a low absorption and finally, fluids show absorption coefficients close to zero. Absorption properties are known to be dependent on the wave frequency, but it is important to know

that amplitude and shape of waveforms also change as they propagate and energy is absorbed into the medium. Absorption in the body is a highly significant effect, especially because it limits the penetration of ultrasound waves in the body, i.e. the maximum depth at which tissues can be imaged. Usually imaging systems have a way of increasing acoustic amplitude as a function of depth to compensate for the absorption phenomenon.

## SURROUNDING TISSUES

The actual temperature rise in tissue depends on several factors including the local specific heat capacity, the time of exposure, the rate of temperature rise and the rate of distribution of heat in neighboring tissue. The measurable parameter for this distribution of heat, known as the perfusion length, depends directly on the thermal conductivity of the tissue and inversely on the blood perfusion flow rate and the specific heat capacity of blood. Perfusion lengths are measured in millimeters and range for different tissues from 1 (for highly vascularized organs) to 20 (for poorly perfused tissue). Blood perfusion plays a significant role in cooling the tissue and must be considered when estimating the tissue temperature and its variations. Tissue with poor vascularization, such as tendon, fat and cornea, and tissue that conduct the heat, such as bone, are subject to higher temperature rises. Where the perfusion length is smaller than any dimension of the insonated volume, heat transfer from surrounding tissue is small. On the contrary, where it is larger than any of the dimensions of the insonated volume, heat transfer within the insonated volume becomes important. Therefore, tissues adjacent to bone are particularly susceptible to heat increase via conduction.

## HEAT CONDUCTION EFFECT

Temperature rise by heat conduction refers to the increase of the local temperature of a tissue that is located close to another heating object. When the temperature gets elevated in a bone structure within the body, due to absorption, the surrounding tissue may then be subject to heating by conduction. This phenomenon is of particular concern for brain heating due to the proximity of the skull. It can also happen when a transducer is selected but left unused. Acoustic power may flow to the outer absorbing lens where it causes self-heating. The transducer itself can then heat the body by conduction due to direct contact when the



operator starts the exam. However, temperature of the probe surface is controlled not to exceed a few degrees when in air and air-gel mixture. When the transducer is in use, the temperature contribution through conduction is often neglected because it is limited to the surface of the body and it is smaller than the absorption contribution.

## SCATTERING

The scattering effect depends on the shape and roughness of the object insonified (scatterer). Three categories can be distinguished, depending on the size of the scatterer.

### Specular Scattering

Specular scattering relates to reflections from objects whose shapes are much bigger than a wavelength. If the object's dimensions are larger than the wavelength, the approximation of the reflection on the object forms a wavefront that mimics the shape of the object.

### Diffuse Scattering

Diffusive scattering happens for objects that are much smaller than a wavelength. Irregularities on the surface of the object create individual reflections that do not cause any significant interference effects. It has important implications in medical imaging because biological tissue is often considered as aggregates of small sub-wavelength point scatterers. Doppler methods measure blood flow depending on scattering effect by numerous small spatially unresolved blood cells. Most ultrasound contrast agents also act as tracers to enhance the scattering of ultrasound on gas-filled resonant spheres.

### Diffraction Scattering

Diffraction scattering occurs on objects slightly less than a wavelength to hundreds of wavelengths. This group of scattering objects is the largest. Scattered waves in this situation can be considered to be originating from the surfaces of the scatterers, which act as secondary ultrasound sources.

## **Spatial Volume of Insonified Tissue**

For a given duration of ultrasound exposure and a given level of acoustic energy delivered, larger volumes of insonated tissue will be submitted to a more diffuse heating, avoiding too high temperatures. At the precise location of ultrasound beam focusing, the temperature will be higher than before or after the focus zone. The aperture of the ultrasound beam also impacts the heating capabilities of the ultrasound beam in the way it generates a more or less focused ultrasound beam, bringing more or less energy into the tissue. As described above, the scanning mode used can also impact the spatial volume of insonified tissue.

## **Homogeneity of Tissue in Insonified Volume**

The homogeneity of tissue being insonified is a key characteristic in heat transfer. The ultrasound waves must typically pass through the several layers of tissue that form organs. These layers influence the absorption of the ultrasound energy since increased absorption in any given layer decreases the ultrasound energy available at the point of interest. The effect of tissue layering on the biological effects of ultrasound has been extensively studied in obstetrics. They demonstrated that the attenuation model that applies best to real observations is the overlying tissue model, in which attenuation depends upon both frequency and non-fluid distance. Furthermore, they demonstrated that the attenuation coefficient asked by the international standards was 2 to 3 times lower than the measured mean values to estimate ultrasonic intensity quantities in tissue.

## Non-thermal Mechanisms

In addition to heat, ultrasound waves also have various types of mechanical effects on biological tissue and media, also called non-thermal effects.

### Cavitation and Role of Gas Bubbles

#### CAVITATION

Acoustic cavitation may occur when the ultrasound beam crosses a cavity area, such as a gas pocket. Some adult tissue contains gas bubbles (lung and intestine), and therefore are more vulnerable to cavitation. With acoustic cavitation, pre-existing bubbles are modified or new bubbles are formed, due to both expansion and contraction of the gas body. The ultrasound waves can lead the bubbles to expand and contract rhythmically, i.e. to pulsate or resonate. The hypothesis of bubbles that would form in tissues and organs that do not contain gases is currently under investigation.

#### RECTIFIED DIFFUSION

Under ultrasound insonification and certain conditions, a gas bubble can resonate and grow instead of dissolving in the medium liquid. The ultrasound wave makes the bubble expand and outer dissolved gases get pumped in, which increases its size rapidly.

### Factors Generating Cavitation

The generation of cavitation depends on numerous factors including the ultrasonic pressure, the type of ultrasound wave emitted (focused or not, pulsed or continuous), the presence of standing waves and the nature and state of the material. Cavitation can be prevented by first being aware of whether or not gas bubbles stay in the tissue being imaged. In liquid media, another significant biological factor over cavitation is the density of the liquid: higher density liquids create intense cavitation with

a greater implosive force. Some technical factors can also be of great help, including limitation of the pressure amplitude of the ultrasound pulse and length of the pulse. When gas bubbles are present in the tissue, their number, size and location are also significant contributors to the effect.

## Types of Cavitation

### STABLE CAVITATION & MICROSTREAMING

Stable cavitation refers to the periodic expansion or contraction of a gas bubble. The gaseous body pulsates due to the ultrasound field, and remains stable. Part of the liquid medium surrounding the gaseous bubbles can begin to stream with the oscillations, leading to microstreaming. Theoretically, microstreaming could also be caused by “acoustic streaming” in fluid media, due to the stirring action of the ultrasound wave. As happens in microstreaming, the acoustic streaming results in a flow of liquid speeding up as the acoustic pressure of the ultrasound increases. This phenomenon could damage cell membranes, which could undergo disruption. However, the real effect of cell membrane damage has only been observed in animal experiments and whether it occurs in humans remains unclear.

### Nucleation sites

When the insonified tissue contains bubbles, gas or vapor, the ultrasound-induced strain may induce cavitation originating from the location of the gas, termed as a “nucleation site”. The exact nature and source of nucleation sites are not well understood in a complex medium such as tissue. Theoretical analyses and predictions have not yet been verified experimentally.

### INERTIAL CAVITATION

The inertial cavitation, called unstable or “transient cavitation” when first observed, refers to the rapid growth and violent collapse of a bubble, seen as a threshold event that tends to increase with frequency. This phenomenon is closely linked to very high temperatures (about

5000°K) and its consequences include the generation of biological toxic compounds, the generation of shock waves, and “sonoluminescence.”

## OTHER MECHANICAL EFFECTS

Ultrasound waves can also generate other mechanical effects that are not related to bubbles. They include changes in pressure, force, torque and streaming; they can produce audible sounds and cause electrical changes in cell membranes, thus increasing their patency to large molecules; they can lead to the movement and redistribution of cells in liquid, and they can also damage cells.

### Radiation Force

Recently, static or dynamic acoustic radiation force techniques have been applied to ultrasound diagnosis. Amongst the different techniques that use radiation force to locally move or vibrate tissue, the technique used by the Aixplorer® system is Supersonic Shear Imaging. This technique utilizes the ultrasound-induced temporal-average force on the medium to create the tissue motion. The magnitude of the effect is proportional to the local temporal-average intensity and is in the range of microns.

## Threshold Phenomena

The cavitation effect is a far more rapid response than temperature rise and is also a threshold phenomenon. In inertial cavitation, the threshold is defined by the amplitude of the ultrasound wave, its frequency, and the size of the pre-existing nucleation sites. The threshold is such that there is a critical size range over which bubbles will undergo inertial cavitation if insonified by an appropriate sound field. In other words, for a given frequency and sound pressure amplitude, bubbles within a certain radius range will undergo inertial cavitation, and those outside of it will not.

## Lung Hemorrhage in Animals

Under experimental circumstances, ultrasound has to be used outside of the diagnostic range in order to be able to detect any adverse bioeffect.

Among them, lung hemorrhage is probably the most extensively studied, although its mechanism still remains unclear. Thermal bioeffects and inertial cavitation have both been excluded as being responsible for lung lesions. However, general observations can be made from the large amount of ultrasound-induced lung damage threshold studies. First, the degree of damage observed in animals does not appear to be a concern since the extent of lung damage is limited and the organ can recover from the effect. Second, the mechanisms of lung injury seem to be similar in all species and the features of the lesions induced are independent from the frequency, pulse repetition frequency, and the beamwidth. Therefore similar biological mechanisms may be of concern in patients undergoing ultrasound lung exposure, and especially patients with pulmonary disorders or “at risk” neonates.

# Benefits of Ultrasound Versus Risks

## Benefits of Use

Without question, ultrasound imaging has had a significant impact on the field of medical diagnostic imaging. Examples of the benefits of ultrasound diagnostic imaging can be easily found in cardiology and obstetrics. In cardiology, ultrasound allows for the detailed visualization of the anatomical structure and function of the heart and its great vessels. The radiologist can see the blood flow within the heart ventricles and atria as well as the function of the valves under normal and pathological conditions. In obstetrics, there is a particular concern for potential bioeffects on the embryo-fetus during pregnancy. However, because of its excellent safety record, this imaging modality is routinely used worldwide. During the past few years, the technology of ultrasound imaging has greatly improved and refers to an expanding array of clinical applications. A variety of ultrasound systems are currently available for specific medical and clinical situations such as elasticity imaging, vascular medicine, cardiac studies and musculoskeletal applications. Recent technological developments have allowed for images of far better quality and also better diagnostic information. However, these technological advances and applications also require more responsibility to be assumed by the operators. From both healthcare systems and patients' perspectives, the cost effectiveness and non invasive nature of ultrasound examinations make them very well tolerated. Ultrasound examinations are universally accepted by patients and their reimbursement agencies.

## Risks of Use

Despite the excellent safety record, the potential risk of adverse biological effects at the tissue and cellular levels exist. As mentioned above, biological mechanisms of lung injury similar to the ones observed in non-human mammals may be of concern in patients undergoing sonographic procedures with lung exposure. There is also the theoretical potential for bioeffects to occur at the subcellular level, although these effects are poorly understood. Adverse bioeffects that were observed in mammals

have never been reported to occur in human patients. Therefore, the regulation now reinforces the operator's responsibility in limiting the potential risk of ultrasound adverse bioeffects to their patients. To achieve this, the operator should be given all the necessary information to make an informed balanced decision, weighing possible bioeffects against the expected diagnostic information. However, newer applications (transesophageal echocardiography, intravascular ultrasound) may cause bioeffects that have never been anticipated. Further specific research is needed in these fields before all risks can be defined.

## **Risk of Not Using Ultrasound**

In the meantime, ultrasound operators should permanently weigh potential biological effects against the real risks of not doing the examination and thus missing key diagnostic information. In obstetrics and cardiology, the clinical diagnostic value of ultrasound information is so well accepted by the medical community, that it is acknowledged that there is a higher risk to the patient if an ultrasound exam is not performed. Ultrasound imaging provides a large amount of highly valuable clinical information that is pertinent to a variety of diagnostic applications. This information can be used instead of a higher risk procedure, or can be used in conjunction with other diagnostic procedures, in order to improve diagnostic confidence or to obtain crucial diagnostic information. In most cases, obtaining the same information with other tests or imaging methods would be at a higher cost or with increased risk.

## **Increase in Risk as Acoustic Output Increases**

At the tissue site where the ultrasound temporal-average intensity is  $I_{TA}$ , the rate of heat generation per unit volume is given by the expression  $Q = 2\alpha I_{TA}$ , where  $\alpha$  stands for the ultrasonic amplitude absorption coefficient. This means that the increase in temperature is proportional to an average value of the ultrasound intensity over a time period, also called the acoustic output. Therefore, the risk of generating thermal bioeffects within insonified tissues depends directly on the acoustic output.



## **Increase in Diagnostic Information as Acoustic Output Increases**

Since 1991, the technical evolution of ultrasound systems has allowed for significant increases in acoustic output and therefore has led to better spatial resolution, enhanced contrasts, increased image definition and improved diagnostic sensitivity. Real 3D and 4D imaging modes, color Doppler, and recently strain imaging illustrate the new and enhanced imaging capabilities of current ultrasound systems. Other potential benefits of increasing the acoustic output include the ability to image at greater depths due to improved echo and Doppler signal acquisition and penetration, and improvements in resolution due to the transmission of higher frequencies. Simultaneously, the scientific knowledge of biological adverse effects of ultrasound has largely expanded and has raised the concept of weighing the risks against the benefits of getting a better ultrasound image.

## **Increase in Responsibility for User at Higher Output Levels**

In relaxing the limits of the acoustic output power on current ultrasound systems, the regulatory authorities of course have allowed the development of increased diagnostic capabilities and image quality, but they have also placed increased responsibility on operators. The operator has to evaluate the risks and benefits of diagnostic ultrasound in general, but also of increasing the acoustic output power to get better images. To fulfil this responsibility, ultrasound operators need to have full knowledge of ultrasound systems and tools. This requires specific education and training, which has now been included as part of the accreditation process for ultrasound clinical use in most developed countries.

The operator should:

1. be familiar with the possible risk factors,
2. be aware of the need to adjust the acoustic output to obtain a good image,
3. evaluate and consider the patient's clinical state and
4. know all the system controls that affect the acoustic output.

Current ultrasound systems allow the operator to balance risks versus benefits and make an informed decision. Systems display real-time information on the potential risks of adverse bioeffects via indices that refer to the output intensity and the possible thermal and mechanical risks (Thermal Index: TI, and Mechanical Index: MI). According to the NCRP, the risks of diagnostic ultrasound have to be weighed against the benefits when the MI is above 0.5 or the TI is above 1.0. Practically speaking, generating a better image may lead to greater risks, especially depending on the patient's anatomy and presentation: thin and obese patients do not present the same risks, full and empty bladder at the time of examination do not have the same risks, and the presence of gas bubbles in the scanned area of the body may increase risk.

## The ALARA Principle

According to the International Commission of Radiological Protection “Medical exposure is the only category in which large reductions in average dose are possible, and it is therefore highly desirable to reduce applications of medical radiation which are of no benefit to the patients and to minimize useless radiation in the course of medical examinations”. To reduce the risks related to ultrasound exposure, the ALARA principle can be applied to ultrasound examinations. ALARA stands for “As Low As Reasonably Achievable”. It means that the total ultrasound exposure has to be kept as low as reasonably achievable, in order to guarantee the patient’s safety while optimizing diagnostic information.

### Controlling energy

The ALARA principle applied to ultrasound diagnostic imaging recommends that the total ultrasound energy should be maintained below a level at which bioeffects are generated while diagnostic information is preserved. The implementation of ALARA enables obtaining the information needed while keeping the potential for bioeffects as low as reasonably achievable. The operator should start the exam by selecting the correct transducer frequency and application and then use a low output level. Then all image quality controls should be used to optimize the image (focus, receiver gain...). Only if the image is not diagnostically useful at this point, then acoustic output can be increased. The output power control allows the operator to select intensity levels less than the established maximum. Prudent use dictates that the operator select the lowest output intensity that is consistent with good image quality.

### Controlling exposure time

The indices that are displayed do not take into account the length of exposure. As the total amount of energy received at a location is proportional to length of exposure of this particular site, the operators should also keep the total exposure time in one location as short as possible. Therefore, a more complete definition of the ALARA principle is to use the lowest output setting that will yield the best possible diagnostic information, while keeping the exposure time as short as possible.

## Controlling scanning technique

The operating guidelines that derive from the ALARA principle should remain very clear and have the only goal of quality of the diagnostic information.

In addition, the operator should ensure that:

- only medically required scanning is performed,
- an exam is not rushed,
- the quality is never compromised.

A poor exam will most probably require a secondary exam or a follow-up, thus increasing exposure time.

## Controlling system setup

Selecting the most appropriate system setup (transducer, application) is the first step to take before starting an ultrasound scan. Then the operator should select the correct range of acoustic intensity for the application, if not done automatically by the system. Ultimately, the operator has the responsibility for proper clinical use. The Aixplorer® ultrasound system provides both automatic (default) settings and manual (user-selectable) settings.

## Effects of system capabilities

The system offers the possibility to control the acoustic output thanks to 3 different types of controls.

**Direct controls** affect directly the acoustic intensity. They include the Application Selection (see above) and the control of the Output Power. The Application Selection affects the allowable output intensity range. Selecting the correct range of acoustic intensity for the application is one of the first things that occur in any exam. For example, peripheral vascular intensity levels are not recommended for fetal exams. Some systems automatically select the proper range for a particular application, while others require manual selection. Ultimately, the user has the responsibility for proper clinical use. The Aixplorer® ultrasound system

provides both automatic (default) settings and manual (user-selectable) settings. The Output Power directly affects the acoustic intensity, by increasing or decreasing it. Once the application has been established, the Output Power control allows the operator to select intensity levels less than the established maximum. Prudent use dictates that the operator select the lowest output intensity that is consistent with good image quality.

**Indirect Controls** are those that have an indirect effect on acoustic intensity. They refer to the transducer selection (see “Effects of transducer capabilities” below), the imaging mode (see “Effects of operating mode” below), the pulse repetition frequency, the focal depth and the pulse length. All of them indirectly impact the output intensity for specific reasons: for example, the transducer operating frequency has to be adapted to the expected depth of scanning; also, a scanned and a stationary mode will not deliver the same amount of energy in a particular location. For complete details on other indirect controls the operator should refer to sub-section “Indirect Controls” in the section “Applying ALARA with the Aixplorer® Ultrasound Imaging System”. Pulse repetition frequency or rate refers to the number of ultrasound bursts of energy over a specific period of time. The higher the pulse repetition frequency, the more pulses of energy in a period of time. Several controls affect pulse repetition frequency: focal depth, display depth, sample volume depth, flow optimization, scale, number of focal zones, and sector width controls. Focus of the ultrasound beam affects the image resolution. To maintain or increase resolution at a different focus requires a variation in output over the focal zone. This variation of output is a function of system optimization. Different exams require different focal depths. Setting the focus at the proper depth improves the resolution of the structure of interest. Pulse length is the time during which the ultrasonic burst is turned on. The longer the pulse, the greater the time-average intensity value. The greater the time-average intensity, the greater the likelihood of temperature increase and cavitation. Pulse length or burst length or pulse duration is the output pulse duration in pulsed Wave Doppler. Increasing the Doppler sample volume size increases the pulse length.

**Receiver controls** have no effect on acoustic output and can be used by the operator to improve image quality. They only change the way the ultrasound echo is received and should always be used before the output power is increased. They include gain, TGC, dynamic range, and image processing features. The important thing to remember, relative to output,

is that receiver controls should be optimized before output is increased. For example: before increasing output, optimize gain to improve image quality.

## Effects of operating mode

The choice of imaging mode determines the nature of the ultrasound beam. For example, the B-Mode is a scanning mode, while Doppler is a stationary or unscanned mode. A stationary ultrasound beam concentrates energy in a single location. A moving or scanned ultrasound beam disperses the energy over an area such that the beam is concentrated on the same area for only a fraction of the time as that of an unscanned mode.

## Effects of transducer capabilities

Transducer selection indirectly affects acoustic output intensity. Tissue attenuation changes with frequency. The higher the transducer operating frequency, the greater the attenuation of the ultrasonic energy. A higher transducer operating frequency requires more output intensity to scan at a deeper depth. To scan deeper at the same output intensity, a lower transducer frequency should be required. Using more gain and output beyond a point, without corresponding increases in image quality, can mean that a lower frequency transducer is needed.



### **WARNING**

Ultrasound exposure time should always be limited; however, do not rush the exam.

Ensure that the indices are kept to a minimum and that exposure time is limited without compromising diagnostic sensitivity.

# The Output Display Standard

## Purpose of the Output Display Standard

The system Output Display Standard (ODS) comprises two basic indices: a mechanical index and a thermal index. The thermal index further consists of the following indices: a thermal index for soft tissue (TIS), a thermal index for bone or tissue located near bone (TIB), and a thermal index for cranial bone (TIC). The Aixplorer user is able to choose the TI and MI display format in the System Configuration, i.e TIS and/or TIB and/or TIC, or the maximum value of the three TI, which in return depends upon the application at hand. Either the TIS or TIB or the maximum value of those indices will be displayed at all times. Which one is displayed depends upon the system preset or user's choice, which in return depends upon the application at hand. The application-specific nature of the default index setting is also an important factor in index behavior. A default setting is a system control state which is preset by the manufacturer or the operator. The system has default index settings corresponding to each transducer application. The default settings are invoked automatically by the ultrasound system when power is turned on, new patient data is entered into the system data base, or a change in application takes place.

The decision as to which of the 3 thermal indices, or the maximum value of the three, to display should be based on the following criteria:

- Appropriate index for the clinical application: TIS is used for imaging soft tissue TIB for a focus at or near bone, and TIC when imaging through the cranial bone or near the skull.
- Factors that might create artificially high or low thermal index readings: location of fluid or bone, or blood flow. For example, if there is a highly attenuating tissue path so that the actual potential for local zone heating is less than the thermal index displays.

Scanned modes versus unscanned modes of operation affect the thermal index. For scanned modes, heating tends to be near the surface; for unscanned modes, the potential for heating tends to be deeper in the focal zone.

## Mechanical Index

Mechanical bioeffects are threshold phenomena that occur when a certain level of output is exceeded. The threshold level varies, however, with the type of tissue. The potential for mechanical bioeffects varies with peak rarefactional pressure and ultrasound frequency. The MI accounts for these two factors. The higher the MI value, the greater the likelihood of mechanical bioeffects occurring. There is no specific MI value that indicates that a mechanical effect is actually occurring. The MI should be used as a guide for implementing the ALARA principle.

## Thermal Index

The TI informs the user about conditions that might lead to an increase in temperature at the surface of the body, within the body tissue, or at the point of focus of the ultrasound beam on bone. That is, the TI informs the user of the potential for temperature rise in body tissue. It is an estimate of temperature increase in body tissue with specific properties. The actual amount of any temperature rise is influenced by factors such as tissue type, vascularity, mode of operation and others. The TI should be used as a guide for implementing the ALARA principle. The bone thermal index (TIB) informs the user about potential heating at or near the focus after the ultrasound beam has passed through soft tissue or fluid, for example, at or near second or third trimester fetal bone. The cranial bone thermal index (TIC) informs the user about the potential heating of bone at or near the surface, for example, cranial bone. The TI informs the user about the general potential for heating within tissue. Depending on the Aixplorer user's choice, the TIS and/or TIB and/or TIC, or the maximum value of the three is continuously displayed over the range of 0.0 to maximum output. The mechanical index is continuously displayed over the range of 0.0 to 1.9.

## System Display Levels and Accuracy for MI and TI

As mentioned above, and depending on the Aixplorer user's choice, the TIS and/or TIB and/or TIC, or the maximum value of the three is continuously displayed from 0.0 to maximum output, based on the



transducer and application, in increments of 0.1. The mechanical index is continuously displayed from 0.0 to 1.9, in increments of 0.1. Therefore, the MI and TI precision is 0.1 unit on the Aixplorer® system. The MI and TI display accuracy estimates for the Aixplorer® system are given in Acoustic Output Tables in this user manual. These accuracy estimates are based on the variability range of transducers and systems, inherent acoustic output modelling errors and measurement variability, as discussed below. The displayed values should be interpreted as relative information to help the operator achieve the ALARA principle through prudent use of the system. The values should not be interpreted as actual physical values in interrogated tissues or organs. The initial data that is used to support the output display is derived from laboratory measurements based on the AIUM measurement standard. The measurements are then put into algorithms for calculating the displayed output values. Many of the assumptions used in the process of measurement and calculation are conservative in nature. Over-estimation of actual in situ intensity exposure, for the vast majority of tissue paths, is built into the measurement and calculation process.

For example:

- The measured water tank values are derated using a conservative, industry standard, and attenuation coefficient of 0.3 dB / cm-MHz.
- Conservative values for tissue characteristics were selected for use in the TI models. Conservative values for tissue or bone absorption rates, blood perfusion rates, blood heat capacity, and tissue thermal conductivity were selected.
- Steady-state temperature rise is assumed in the industry standard TI models, and the assumption is made that the ultrasound transducer is held steady in one position long enough for steady state to be achieved.

A number of factors are considered when estimating the accuracy of the displayed values: hardware variations, estimation algorithm accuracy, and measurement variability. Variability among transducers and systems is a significant factor. Transducer variability results from piezoelectric crystal efficiencies, process-related impedance differences, and sensitive lens focusing parameter variations. Differences in system pulser voltage control and efficiency may also contribute to variability. There are inherent uncertainties in the algorithms used to estimate acoustic output values over the range of possible system operating conditions and pulser voltages. Inaccuracies in laboratory measurements are related to, among others, differences in hydrophone calibration and performance, positioning, alignment, and digitization tolerances, and variability among

test operators. The conservative assumptions of the output estimation algorithms of linear propagation, at all depths, through a 0.3 dB/cm-MHz attenuative medium is not considered in the accuracy estimate for the display. Neither linear propagation, nor uniform attenuation at the 0.3 dB/cm-MHz rate, occurs in water tank measurements or in most tissue paths in the body. In the body, different tissues and organs have dissimilar attenuation characteristics. In water, there is almost no attenuation. In the body, and in particular, in water tank measurements, non-linear propagation and saturation losses occur as pulser voltages increase. Therefore, the display accuracy estimates are based on the variability range of transducers and systems, inherent acoustic output modelling errors, and measurement variability. Display accuracy estimates are not based on errors in, or caused by measuring according to, the AIUM measurement standards, or the effects of non-linear loss on the measured values.

## **Meaning of the TI and MI and Relation with Bioeffects**

### THERMAL INDEX

The TI gives a relative indication of the potential for temperature increase at a specific point along the ultrasound beam. The reason for the term 'relative' is that the assumed conditions for heating in tissue are so complex that this index cannot be assumed to give the actual increase in temperature for all possible conditions. Thus, a TI of 2 represents a higher temperature rise than a TI of 1, but does not necessarily represent a rise of 2° C. This temperature rise is a theoretical estimate based on experimental conditions that may not apply to clinical conditions. The important point to remember about the TI is that it is designed to make users aware of the possible temperature rise at a particular point in tissue. The concern over temperature rise induced by ultrasound in the body is based on observed changes in cellular activity as a function of temperature. In general, for healthy activity of enzymes, the enzymatic activity doubles for every 10° C rise. The human body is able to tolerate hot drinks and fevers for a certain period of time. A fever of +2° C is not a problem, where 37° C is taken as an average core body temperature. The following table identifies stages of temperature effects.

Table 3.4. Temperature Effect from Millet and Ziskin, 1989

Temperature Range (Degrees Centigrade)	Effect
37-39	No harmful effects for extended periods
39-43	Detrimental effects for long enough times
>41	Threshold for fetal problems for extended periods
44-46	Coagulation of protein
>45	Enzymes become denatured
>41.8	Cancer cells die (fail to reproduce) Often taken as damage threshold, except eye

The temperature rise in tissue during ultrasonic exposure is due to the absorption of acoustic energy. Absorption is the conversion of ultrasonic energy into heat. The extent of the absorption depends on the tissue type. A specific way in which tissue absorption characteristics are quantified is the “Absorption coefficient”. The absorption coefficient is expressed in decibels per centimeter per MegaHertz. Absorption coefficients are very dependent on the organ or tissue type that is being imaged. Amniotic fluid, blood and urine have very low absorption coefficients, which mean that there is little temperature elevation and the ultrasound goes through the fluid with very little decrease. Bone, however, has a very high absorption coefficient. Dense bone absorbs the energy very quickly and causes the temperature to rise rapidly. Soft tissues vary in density depending on the particular organ, but the density does not vary much within an organ. Ultrasonic frequency affects absorption. The higher the frequency, the higher the absorption. How to minimize temperature rise: The temperature increase depends on the intensity, duration of exposure at the same location, transducer focal point size and location, and absorption of the energy by the tissue. The operator can control the intensity (output power control), the duration or the exposure time. The transducer is typically moved frequently during the exam, which reduces the exposure duration at a specific tissue location. The other important factor of temperature rise is absorption of the ultrasound energy in tissue layers in front of the point of interest. Increased absorption in these layers decreases the ultrasound energy available at the point of interest.

## MECHANICAL INDEX

In addition to heat effect, various types of mechanical effects on the body are generated by ultrasonic exposure. These effects can be divided into two categories. The first category is called acoustic cavitation. Cavitation can occur when sound passes through an area that contains a cavity, such as a gas bubble or other air pocket. Some tissues, most notably adult lung and intestine, do contain air bubbles, and are therefore more vulnerable to these cavitation effects. The fetal lung and intestine do not contain obvious air bubbles, because the fetus does not breathe air yet—it gets oxygen from the mother’s blood stream. However, tiny bubbles could potentially form in parts of the body other than the lung and intestine. More research is needed in this area. In cavitation, the sound waves can cause the bubbles or air pockets to expand and contract rhythmically: in other words, to pulsate, or resonate. When they pulsate, the bubbles send secondary sound waves off in all directions. If the bubbles contract towards the point of collapsing, they can build up very high temperatures and pressures for a few tens of nanoseconds. These high temperatures and high pressures can produce highly reactive chemicals called free radicals, and other potentially toxic compounds which, although considered unlikely, could theoretically cause genetic damage. The rapid contraction of bubbles in cavitation can also cause micro-jets of liquid which can damage cells. When diagnostic ultrasound is focused on the lung or intestine of laboratory animals, which contain gas bubbles, these cavitation effects can cause ruptures in very small blood vessels. The safety guidelines for diagnostic ultrasound are designed to try to prevent cavitation effects, because these effects can be damaging. Restrictions on the pressure amplitude of the ultrasound pulse, in combination with awareness of whether or not there are gas bubbles in the tissue being imaged, can help prevent cavitation. Other factors such as the length of the pulse, and the density of the liquid, also influence whether or not cavitation occurs. And if there are gas bubbles, the number, size and location of the bubbles also contribute to the effect. The occurrence of cavitation and its behavior depend on many factors, including the ultrasonic pressure and frequency, the focused or unfocused and pulse or continuous ultrasonic field, the degree of standing waves, and the nature and state of the material and its boundaries. Currently there is no evidence of cavitation occurring in human tissue or fluids resulting from diagnostic ultrasonic exposure. In addition, the control parameters on our ultrasound imaging system limit the peak output. Ultrasound can also create other mechanical effects that do not require the presence of bubbles in order to occur. These effects include changes in pressure, force, torque (causing

things to rotate) and streaming (stirring of the liquid). These changes, in turn, can cause audible sounds, electrical changes in cell membranes that make them more permeable to large molecules, movement and redistribution of cells in liquid, and cell damage. When ultrasound passes through liquid, it causes a sort of stirring action called acoustic streaming. As the acoustic pressure of the ultrasound increases, the flow of liquid speeds up. This stirring action, in theory, could occur in fluid-filled parts of a patient's body, such as blood vessels, the bladder or amniotic sac. In experiments with animals, when streaming of the liquid comes near a solid object, shearing can occur, and this can damage platelets and lead to abnormal blood clotting (thrombosis). It is not clear to what extent this effect occurs in humans exposed to diagnostic ultrasound. Although possible adverse effects of ultrasound exist, the overall risk of undergoing an ultrasound diagnostic examination has been found to be minimal, even under moderate to prolonged exposure. Under normal circumstances of diagnostic examination, ultrasound applied prudently using the ALARA principle has been shown to be a safe, effective and reliable diagnostic tool.

# Practicing the ALARA Principle

## How to Implement ALARA

### ALARA PRINCIPLE

The guiding principle for the use of diagnostic ultrasound is defined by the “As Low As Reasonably Achievable” (ALARA) principle. The decision as to what is reasonable has been left to the judgment and insight of qualified personnel. No set of rules can be formulated that would be sufficiently complete to dictate the correct response to every circumstance. By keeping ultrasound exposure as low as possible, while obtaining diagnostic images, users can minimize potential ultrasonic bioeffects.

### USERS SHOULD FOLLOW THE ALARA PRINCIPLE IN ALL STUDIES

Since the threshold for diagnostic ultrasound bioeffects is undetermined, it is the operator’s responsibility to control total energy transmitted into the patient. The operator must reconcile exposure time with diagnostic image quality. To ensure diagnostic image quality and limit exposure time, an ultrasound system provides controls that can be manipulated during the exam to optimize the results of the exam. The ability of the user to abide by the ALARA principle is important. Advances in diagnostic ultrasound - not only in the technology but in the applications of that technology, have resulted in the need for more and better information to guide the user. The output display indices are designed to provide that important information. There are a number of variables which affect the way the output display indices can be used to implement the ALARA principle. These variables include index values, body size, location of the bone relative to the focal point, attenuation in the body, and ultrasound exposure time. Exposure time is an especially useful variable, because it is controlled by the user. The ability to limit the index values over time supports the ALARA principle.

## IMPLEMENTING ALARA USING THE TI AND MI INDICES

The ALARA concept is achieved by using the information displayed on the screen in the form of biologically relevant exposure indices: the TI and the MI. The display of biological index information is only a tool. Safe use of the ultrasound imaging device can be ensured by using the lowest indices that will yield the best possible diagnostic information.

## SYSTEM CONTROLS VERSUS ACOUSTIC OUTPUT

An ultrasound scan of a patient begins with selecting the appropriate transducer frequency. After selecting the transducer and the application, which are based on patient anatomy, adjustments to output power should be made to ensure that the lowest possible setting is used to acquire an image. After the image is acquired, adjusting the focus of the transducer, and then increasing the receiver gain, dynamic range, and the TGC to produce a uniform representation of the tissue follows. If an adequate image can be obtained with the increase in gain and adjusting the TGC, then a decrease in output should be made. Only after making these adjustments should the operator increase output to the next level. Having acquired the B-mode display of the scanned organ, Color Flow Imaging can be used to localize blood flow. As with the B-mode image display, gain, TGC, and image processing controls must be optimized before increasing output. Having localized the blood flow, use the Doppler controls to position the sample volume over the vessel. Before increasing output, adjust velocity range or scale and Doppler gain to obtain an optimal Doppler trace. Only if maximum Doppler gain does not create an acceptable image does the operator increase output. In summary: select the correct transducer frequency and application for the job; start with a low output level; optimize the image using focus, receiver gain, and other imaging controls; if the image is not diagnostically useful at this point, then increase output. Overall gain and TGC are the 2 most important receiver controls that must be used by the operator to improve image quality, before increasing the acoustic output. These controls have no effect on acoustic output and only affect the way the ultrasound echo is received. The important thing to remember, relative to output, is that receiver controls should be optimized before output is increased. For example: before increasing output, optimize gain to improve image quality. Dynamic range and image post-processing are also receiver

controls that have no effect on acoustic output power. Again, it is of first importance for the operator to remember that these two controls also should be optimized before output is increased.

## **System Application Versus Acoustic Output**

Application selection and the Output Power control directly affect acoustic intensity. There are different ranges of allowable intensity or output based on operator's selection. Selecting the correct range of acoustic intensity for the application is one of the first things that occurs in any exam. For example, peripheral vascular intensity levels are not recommended for fetal exams. Some systems automatically select the proper range for a particular application, while others require manual selection. Ultimately, the user has the responsibility for proper clinical use. The Aixplorer® ultrasound system provides both automatic (default) settings and manual (user-selectable) settings. Output Power has direct impact on acoustic intensity. Once the application has been established, the Output Power control can be used to increase or decrease the intensity output. The Output Power control allows the operator to select intensity levels less than the established maximum. Prudent use dictates that the operator selects the lowest output intensity that is consistent with good image quality.

## **Transducer Effect on Acoustic Output**

The controls that affect the acoustic output are:

- pulse repetition frequency,
- focus depth,
- pulse length,
- transducer selection.

Pulse repetition frequency or rate refers to the number of ultrasound bursts of energy over a specific period of time. Dwell time is equal to the inverse of the pulse repetition frequency minus the burst length. The higher the pulse repetition frequency, the more pulses of energy in a period of time and the shorter the dwell time. Several controls affect pulse repetition frequency: focal depth, display depth, sample volume



depth, flow optimization, scale, number of focal zones, and sector width controls. Focus of the ultrasound beam affects the image resolution. To maintain or increase resolution at a different focus requires a variation in output over the focal zone. This variation of output is a function of system optimization. Different exams require different focal depths. Setting the focus at the proper depth improves the resolution of the structure of interest. Pulse length is the time during which the ultrasonic burst is turned on. The longer the pulse, the greater the time-average intensity value. The greater the time-average intensity, the greater the likelihood of temperature increase and cavitation. Pulse length, also known as burst length or pulse duration, is the output pulse duration in pulsed Doppler. Increasing the Doppler sample volume size increases the pulse length. Transducer selection indirectly affects intensity. Tissue attenuation changes with frequency. The higher the transducer operating frequency, the greater the attenuation of the ultrasonic energy. A higher transducer operating frequency requires more output intensity to scan at a deeper depth. To scan deeper at the same output intensity, a lower frequency transducer is required. Using more gain and output beyond a point, without corresponding increases in image quality, can mean that a lower frequency transducer is needed.

## **System Operating Modes versus Acoustic Output**

The choice of imaging mode determines the nature of the ultrasound beam. B-mode is a scanning mode, Doppler and M-mode are stationary or unscanned modes. A stationary ultrasound beam concentrates energy in a single location. A moving or scanned ultrasound beam disperses the energy over an area such that the beam is concentrated on the same area for only a fraction of the time as that of an unscanned mode.

ShearWave™ Elastography mixes the two types of scanned and unscanned modes:

- the generation of the acoustic radiation force is a scanned ultrasound emission,
- the acquisition of the shearwave propagation is achieved by unscanned flat insonification at a very high frequency (UltraFast™),
- the B mode imaging is performed in an interleaved manner with the elastography sequence and is a scanned mode.

## Control of Exposure Time

One important contributor to ALARA, not incorporated in the output display indices, is the element of time. As the total exposure is directly proportional to the amount of time the ultrasound beam remains in one area, users should remember that, besides keeping the TI and MI as low as possible, the total exposure time in any one location should be kept as short as possible. The concept of ALARA is to use the lowest output setting that will yield the best possible diagnostic information, while keeping the exposure time as short as possible. With a clear understanding of the new responsibilities, users will have more capabilities and potentially more diagnostic information available from these higher output devices, while minimizing risk to patients. Ensure that scanning time is kept to a minimum, and ensure that only medically required scanning is performed. Never compromise quality by rushing through an exam. A poor exam may require a follow-up, which ultimately increases exposure time. Diagnostic ultrasound is an important tool in medicine, and, like any tool, it should be used efficiently and effectively.

## Applying ALARA with the Aixplorer® Ultrasound Imaging System

The system imaging mode used depends upon the information needed. B-mode imaging provides anatomical information. Pulsed Doppler, Color Power Imaging (CPI), Directional Color Power Imaging (DCPI) and Color Flow Imaging (CFI) provide information about blood flow. The M-mode is used for cardiac assessment and measurement of the fetal heart rate. ShearWave™ Elastography Imaging displays information about tissue stiffness via color-scale or grayscale. A scanned mode, like B-mode, SWE™, CPI, DCPI, or CFI, disperses or scatters the ultrasonic energy over an area, while an unscanned mode, like Pulsed Wave Doppler, concentrates ultrasonic energy. The M-mode should be used instead of spectral Pulsed Wave Doppler imaging to document embryonic/fetal heart rate. Understanding the nature of the imaging mode being used allows the operator to apply the ALARA principle with informed judgment. Additionally, knowing the transducer frequency, system setup values, and scanning techniques, and the operator's experience allow him or her to meet the ALARA principle. The decision as to the amount of acoustic output is, in the final analysis, up to the operator. This decision must be based on the following factors: type

of patient, type of exam, patient history, ease or difficulty of obtaining diagnostically useful information, and the potential localized heating of the patient due to transducer surface temperatures. Prudent use of the system occurs when patient exposure is limited to the lowest index reading for the shortest amount of time necessary to achieve acceptable diagnostic results. Although a high index reading does not mean that a bioeffect is actually occurring, a high index reading should be taken seriously. Every effort should be made to reduce the possible effects of a high index reading. Limiting exposure time is an effective way to accomplish this goal. There are several system controls that the operator can use to adjust the image quality and limit the acoustic intensity. These controls are related to the techniques that an operator might use to implement ALARA. These controls can be divided into three categories: direct, indirect, and receiver controls. As various system controls are adjusted, the TI and MI values may change. This will be most apparent as the Output Power control is adjusted; however, other system controls will affect the on-screen output values.

## DIRECT CONTROLS

### Output Power

Output Power controls the system acoustic output. Two real-time output values are on the screen: a TI and MI. They change as the system responds to Output Power adjustments. In combined modes, such as simultaneous CFI, B-mode, the individual modes each add to the total TI. One mode will be the dominant contributor to this total. The displayed MI will be from the mode with the largest peak pressure.

## INDIRECT CONTROLS

### B Controls

#### **SECTOR WIDTH**

Narrowing the sector angle may increase frame rate. This action will increase the TI. Pulsar voltage may be automatically adjusted down with software controls to keep the TI below the system maximums. A decrease in pulsar voltage will decrease MI.

#### **ZOOM**

Increasing the zoom magnification by pressing Zoom may increase frame rate. This action will increase the TI. The number of focal zones may also increase automatically to improve resolution. This action may change MI since the peak intensity can occur at a different depth.

#### **NUMBER OF FOCAL ZONES**

More focal zones may change both the TI and MI by changing frame rate or focal depth automatically. Lower frame rates decrease the TI. MI displayed will correspond to the zone with the largest peak intensity.

#### **FOCUS**

Changing the focal depth will change MI. Generally, higher MI values will occur when the focal depth is near the natural focus of the transducer.

### M Controls

The M-mode is accessible from the B-mode controls. All 2D controls mentioned above apply to the M-mode image. Similarly, the MI and/or TI are displayed on the Aixplorer® monitor when operated in M-mode. Additional indirect controls dedicated to the M-mode also impact on the TI and MI.

## **SAMPLE VOLUME DEPTH**

When M-mode sample volume depth is increased the PRF may automatically increase, leading to an increase of the TI.

## **CFI, CPI and DCPI Controls**

## **VELOCITY OPT**

Increasing the Color sensitivity with the Velocity Opt control may increase the TI. More time is spent scanning the Color image. Color pulses are the dominant pulse type in this mode.

## **COLOR BOX/SECTOR WIDTH**

Narrower color sector width will increase color frame rate and the TI will increase. The system may automatically decrease pulser voltage to stay below the system maximum. A decrease in pulser voltage will decrease the MI.

## **COLOR BOX/SECTOR DEPTH**

Deeper color sector depth may automatically decrease color frame rate or select a new color focal zone or color pulse length. The TI will change due to the combination of these effects. Generally, the TI will decrease with increased color sector depth. MI will correspond to the peak intensity of the dominant pulse type which is a color pulse.

## **SCALE**

Using the scale control to increase the color velocity range may increase the TI. The system may automatically adjust pulser voltage to stay below the system maximums. A decrease in pulser voltage will also decrease MI.

## **SECTOR WIDTH**

A narrower 2D sector width in Color imaging will increase color frame rate. The TI will increase. MI will not change.

## Pulsed Wave Doppler Controls

### **SAMPLE VOLUME DEPTH**

When Doppler sample volume depth is increased the Doppler PRF may automatically decrease. An increase in PRF will increase the TI. The system may also automatically decrease the pulser voltage to remain below the system maximum. A decrease in pulser voltage will decrease MI.

## Elastography Controls

### **HD/FRAME RATE OPT**

Setting the HD/Frame Rate control to HD will increase sensitivity but may increase the TI, because more time is spent scanning in Elastography.

### **ELASTOGRAPHY BOX/SECTOR WIDTH**

Narrower Elastography sector width may increase elastography frame rate and the TI will increase. The system may automatically decrease pulser voltage to stay below the system maximum. A decrease in pulser voltage will decrease the MI.

### **ELASTOGRAPHY BOX/SECTOR DEPTH**

Deeper Elastography sector depth may automatically decrease elastography frame rate. The TI will change. Generally, the TI will

decrease with increased Elastography sector depth. MI will correspond to the peak intensity of the dominant pulse type in the combined mode.

### **SECTOR WIDTH**

A narrower 2D sector width in Elastography imaging will decrease the Elastography frame rate. The TI will increase. MI will not change.

Other

### **B-MODE, CFI, CPI, DCPI, PULSED WAVE DOPPLER, AND ELASTOGRAPHY**

When a new imaging mode is selected, both the TI and MI may change to default settings. Each mode has a corresponding pulse repetition frequency and maximum intensity point. In combined or simultaneous modes, the TI is the sum of the contribution from the modes enabled and MI is the MI for the focal zone and mode with the largest derated intensity.

### **DEPTH**

An increase in B-mode depth will automatically decrease the B-mode frame rate. This would decrease the TI. The system may also automatically choose a deeper B-mode focal depth. A change of focal depth may change the MI. The MI displayed is that of the zone with the largest peak intensity.

### **APPLICATION**

Acoustic output defaults are set when the operator selects an application. Factory defaults vary with transducer, application, and mode. Defaults have been chosen below the FDA limits for intended use.

# Clinical Application Examples

## SMALL PARTS

For any small parts, the clinician starts with selecting the appropriate Tissue Preset Setting and application (Breast & Superficial Breast, Deep Breast, Scrotum, Thyroid, or General on the SL15-4 or Breast or general on the SLV16-5), the clinician starts imaging the tissue and starts adjustments of the output power to ensure that the lowest possible setting is used to obtain a B Mode image. The user shall then adjust the spread and depth of the focal zone of the transducer, and then using the AutoTGC key or increasing the receiver gain to produce a uniform representation of the tissue follows. If an adequate image can be obtained with the adjustment/increase in gain, then a decrease in output should be made. Only after making these adjustments should the operator increase output to the next level in the case of an unsatisfying image.

Having acquired the B Mode images of the small part/superficial tissue, CFI CPI and/or DCPI can be used to localize blood flow. As with the B Mode image display, gain and image processing controls must be optimized before increasing output, if ever needed.

Having localized the blood flow, the clinicians shall use the Pulsed Wave Doppler controls to position the sample volume over the vessel. Before increasing output, the user shall adjust velocity range or scale and Doppler gain to obtain an optimal Doppler trace. Only if maximum Doppler gain does not create an acceptable Doppler spectrum does the operator increase output.

Having acquired 2D, Color Flow and Pulsed Wave Doppler, Elastography can be used to assess the tissue stiffness. SWE Opt. setting (Resolution, Standard or Penetration), size and location of the SWE Box and SWE gain shall be adjusted to obtain an optimal Elastography image before increasing output. Only if optimal settings and maximum Elastography gain do not create an acceptable image does the operator increase output.

A Three-dimensional acquisition can be performed with the SLV16-5 of B-Mode of ShearWave™ Elastography once the conventional two-dimensional planes have been acquired.



## MSK

For any MSK, the clinician starts with selecting the appropriate Tissue Preset Setting and application (MSK or deep MSK on the SL15-4 probe), the clinician starts imaging the tissue and starts adjustments of the output power to ensure that the lowest possible setting is used to obtain a B Mode image. The user shall then adjust the spread and depth of the focal zone of the transducer, and then using the AutoTGC key or increasing the receiver gain to produce a uniform representation of the tissue follows. If an adequate image can be obtained with the adjustment/increase in gain, then a decrease in output should be made. Only after making these adjustments should the operator increase output to the next level in the case of an unsatisfying image.

Having acquired the B Mode images of the small part/superficial tissue, CFI, CPI and/or DCPI can be used to localize blood flow. As with the B Mode image display, gain and image processing controls must be optimized before increasing output, if ever needed.

Having localized the blood flow, the clinician shall use the Pulsed Wave Doppler controls to position the sample volume over the vessel. Before increasing output, the user shall adjust velocity range or scale and Doppler gain to obtain an optimal Doppler trace. Only if maximum Doppler gain does not create an acceptable Doppler spectrum does the operator increase output.

Having acquired 2D, Color Flow and Pulsed Wave Doppler, Elastography can be used to assess the tissue stiffness. SWE Opt. setting (Resolution, Standard or Penetration), size and location of the SWE Box and SWE gain shall be adjusted to obtain an optimal Elastography image before increasing output. Only if optimal settings and maximum Elastography gain do not create an acceptable image does the operator increase output.

## ABDOMINAL/PELVIC

For abdominal imaging, the clinician starts with selecting the appropriate transducer (SC6-1 for deep abdominal Imaging and SL15-4 or SL10-2 intestine Preset for superficial ) and the appropriate Tissue Preset Setting (Renal, Pelvis, Abdomen, Prostate, Gyn for SC6-1 and Intestine for the SL15-4 or SL10-2). The clinician then starts imaging the target organ and adjusts the output power to ensure that the lowest possible setting is used to obtain an adequate B Mode image. After the first B Mode image is obtained, adjusting the depth and spread of the focal zone, and then increasing the receiver gain should be used first to produce a uniform representation of the tissue. If an adequate image can be obtained with the increase in gain, then a decrease in output should be made. Only after making these adjustments should the operator increase output to the next level, if ever needed.

Having acquired the B Mode images of the target organ, CFI, CPI and/or DCPI can be used to localize blood flow. As with the B Mode image display, gain and image processing controls must be optimized before increasing output. In case of artifacts due to the increase in gain, the user shall activate the Flash suppression key to be able to increase gain and decrease output acoustic power.

Having localized the blood flow, the operator shall use the pulsed wave Doppler controls to position the sample volume over the vessel. Before increasing output, the operator shall adjust velocity range or scale and Doppler gain to obtain an optimal Doppler trace. Only if maximum Doppler gain does not create an acceptable Doppler spectrum does the operator increase output.

Having acquired 2D, Color Flow and Doppler, Elastography can be used to assess the organ tissue stiffness. Before increasing output, the user should first adjust the appropriate SWE Opt. setting (Resolution, Standard or Penetration), adjust the size and location of the SWE box and adjust SWE gain to obtain an optimal Elastography image. Only if maximum Elastography gain does not create an acceptable image does the operator increase output.

## ENDOCAVITARY

For prostate and gynecologic imaging, the clinician starts with selecting the appropriate transducer (SE12-3 for intracavitary scanning) and the desired clinical application (Prostate, Gyn). The clinician then images the target organ and adjusts the output power to ensure that the lowest possible setting is used to obtain a B Mode image. After the first B Mode image is obtained, adjusting the depth and spread of the focal zone, and then increasing the receiver gain should be used first to produce a uniform representation of the organ. If an adequate image can be obtained with the increase in gain, then a decrease in output should be made. Only after making these adjustments should the operator increase output to the next level, in case of poor quality images.

Having acquired the B Mode images of the organ, CFI, CPI and/or DCPI can be used to localize blood flow. As with the B Mode image display, gain and image processing controls must be optimized before increasing output. The user shall then turn on the Power Doppler Mode and adjust its controls to position the sample volume over the vessel. Before increasing output, the user shall adjust velocity range or scale and Doppler gain to obtain an optimal Doppler trace. Only if maximum Doppler gain does not create an acceptable image does the operator increase output.

Having acquired B Mode, Color Flow and Pulsed Wave Doppler images, Elastography can be used to assess the target organ tissue stiffness. Before increasing output, the user should first adjust the appropriate SWE Opt. setting (Resolution, Standard or Penetration), adjust the size and location of the SWE box and adjust SWE gain to obtain an optimal Elastography image. Only if maximum Elastography gain does not create an acceptable image does the operator increase output.

## VASCULAR

For vascular imaging, the clinician starts with selecting the appropriate transducer (SL15-4 for superficial vascular imaging, SL10-2 for deep vascular imaging; SC6-1 for vascular abdominal imaging) and the appropriate Tissue Preset Setting (Carotid, Upper Extremity Arterial/Venous, Lower Extremity Arterial/Venous) for SL15-4 or SL10-2, and Vascular Abdominal for SC6-1). The clinician then starts imaging the target vessel or organ and adjusts the output power to ensure that the lowest possible setting is used to obtain an adequate B Mode image. After the first B Mode image is obtained, adjusting the depth and spread of the focal zone, and then increasing the receiver gain should be used first to produce a uniform representation of the vessel or the organ. If an adequate image can be obtained with the increase in gain, then a decrease in output should be made. Only after making these adjustments should the operator increase output to the next level, if ever needed.

Having acquired the B Mode images of the target vessel or organ, CFI, CPI and/or dCPI can be used to localize blood flow. As with the B Mode image display, gain and image processing controls must be optimized before increasing output. In case of artifacts due to the increase in gain, the user shall activate the Flash suppression key to be able to increase gain and decrease output acoustic power.

Having localized the blood flow, the operator shall use the pulsed wave Doppler controls to position the sample volume over the vessel. Before increasing output, the operator shall adjust velocity range or scale and Doppler gain to obtain an optimal Doppler trace. Only if maximum Doppler gain does not create an acceptable Doppler spectrum does the operator increase output.

## OBSTETRICS

Diagnostic ultrasound studies of the fetus are generally considered safe during pregnancy. This diagnostic procedure should be performed only when there is a valid medical indication, and the lowest possible ultrasonic exposure setting should be used to gain the necessary diagnostic information under the ALARA (as low as reasonably achievable) principle.

The thermal index for soft tissue (TIS) should be used at earlier than 10 weeks' gestation, and the thermal index for bone (TIB) should be used at 10 weeks' gestation or later when bone ossification is evident. In keeping with the ALARA principle, M-mode imaging should be used instead of spectral Doppler imaging to document embryonic/fetal heart rate.

For a use of the Early OB preset on the SC6-1 and SE12-3, the system is limiting the Mechanical Index to a maximum value of 1.0 (on both probes) and the Thermal Index to a maximum value of 2.0 (on both probes). These limits are following the recommendations and the guidelines for safe use of an ultrasound diagnostic system during a fetal exam:

- American institute of ultrasound of medicine (AIUM)
- British medical ultrasound society (BMUS)
- European committee for medical ultrasound safety (ECMUS)
- Société des obstétriciens et gynécologues du Canada (SOCG) et Santé Canada

And more particularly the information provided by the AIUM on the ultrasound biological effects, its recommendations published in the Journal of Ultrasound in Medicine in April 2008, and the article published by DL Miller.

During the first trimester of pregnancy and especially during the first 10 weeks, it is essential to follow these recommendations.

For obstetrics imaging, the clinician starts with selecting the appropriate transducer (SE12-3 for Early OB scanning, SC6-1 for General OB scanning) and the desired clinical application (OB-GYN- application, GYN, Early OB or Gen OB). The clinician then images the target organs and adjusts the output power to ensure that the lowest possible setting is used to obtain a B Mode image. (Obstetrics presets have a limited Mechanical Index and Thermal Index [MI & TI] to follow

the recommendations and guidelines from AIUM, BMUS, ECMUS and SOCG). After the first B Mode image is obtained, adjusting the depth and spread of the focal zone, and then increasing the receiver gain should be used first to produce a uniform representation of the organ. If an adequate image can be obtained with the increase in gain, then a decrease in output should be made. Only after making these adjustments should the operator increase output to the next level, in case of poor quality images.

Having acquired the B Mode images of the organs, CFI, CPI and/or DCPI can be used to localize blood flow. As with the B Mode image display, gain and image processing controls must be optimized before increasing output.

Having acquired B Mode and Color Flow, the user can image the desired organ using M-Mode imaging. M-Mode can be used to assess the beats per minute of fetal cardiac activity. Before increasing output, the user should first adjust the appropriate B/M- Mode parameters such as gain, maps, dynamic range, adjust the size and location of the M zone to obtain an optimal M-Mode image. Only if maximum M-Mode gain does not create an acceptable image does the operator increase output.

Having acquired B Mode, Color Flow & M-Mode, the clinician also has the ability to use Pulsed Wave (PW) Doppler and adjust its controls to position the sample volume over the vessel. Before increasing output, the user shall adjust velocity range or scale and Doppler gain to obtain an optimal Doppler trace. Only if maximum Doppler gain does not create an acceptable Doppler spectrum does the operator increase output. PW Doppler can be used to assess blood flow in the later stages of the fetal development.

# Alarm System

The usage of the Aixplorer® ultrasound system requires the physical presence of the operator. The operator and patient are co-located to the system. Thus the Aixplorer® alarm system is composed of visual alarms only. The Aixplorer® alarm system utilizes either a pop-up window with suggested actions or a message in the information area of the main monitor. The Aixplorer alarm conditions are not configurable by an operator. The Aixplorer logs the occurrences of alarms for later review by a SuperSonic Imagine representative. The medium priority alarms are used to intervene automatically by halting the system upon detection of an alarm condition that may result in harm to the patient, operator, or the system. The operator is instructed via a visual alarm. The course of operator's actions is limited to contacting an SuperSonic Imagine representation and acknowledgement of the restarting the system. The low priority alarms are used as informational. The user may be able to take action to resume system usage or the alarm is strictly to inform the user of a condition that may impact workflow.

The following alarms display pop-windows of a **medium** priority:

Alarm Condition	Message
Acoustic power	API error : Please reboot and contact representative A problem in acoustic power intensity computation has occurred.
BLS (Board Level Sequencer)	Hardware error: Reboot is required. Please contact a SuperSonic Imagine representative. An unexpected problem has occurred.
BLS CRC	Hardware error: Reboot is required. Please contact a SuperSonic Imagine representative. A problem occurred on crc transmit.
Channel Group	Hardware error: Reboot is required. Please contact a SuperSonic Imagine representative. An unexpected problem has occurred.
Hardware enumeration	Hardware error: Reboot is required. Please contact a SuperSonic Imagine representative. A problem has occurred during the enumeration process
Hardware failure	Hardware error: Reboot is required. Please contact a SuperSonic Imagine representative. An unexpected problem has occurred.
Hardware loading sequence	Hardware error: Reboot is required. Please contact a SuperSonic Imagine representative. A problem has occurred during sequence loading.
Hardware version	Hardware error: Reboot is required. Please contact a SuperSonic Imagine representative. The firmware/kernel version does not match the software version.
Power Supply	Hardware error: Reboot is required. Please contact a SuperSonic Imagine representative. A problem has occurred in the TPC : Communication
Power Supply monitoring	Hardware error: Reboot is required. Please contact a SuperSonic Imagine representative. A problem has occurred in the TPC : Monitoring
Power Supply setting	Hardware error: Reboot is required. Please contact a SuperSonic Imagine representative. A problem has occurred in the TPC : Settings
Temperature monitoring	ERROR An error occurred, Temperature monitoring is not available
Transducer Interface	Hardware error: Reboot is required. Please contact a SuperSonic Imagine representative.



Alarm Condition	Message
	A problem has occurred in the SHI
Transducer Interface temperature	Hardware error: Reboot is required. Please contact a SuperSonic Imagine representative. Probe's temperature is higher than limit
Unexpected hardware problem	Hardware error: Reboot is required. Please contact a SuperSonic Imagine representative. An unexpected problem has occurred.
Signal processing stopped	Hardware error: Reboot is required. Please contact s SuperSonic Imagine representative. Acquired data not being processed.
High temperature	System must be stopped for safety reason (temperature is too high).

The following alarms display pop-windows of a **low** priority:

Alarm Condition	Message
3D Controller unconnected	<p>Hardware error ; 3D imaging is not available Please contact a SuperSonic Imagine representative. The 3D controller is not connected, please check the connection or change probe</p>
3D Controller version	<p>Hardware error ; 3D imaging is not available Please contact a SuperSonic Imagine representative. The 3D controller is not identify or not connected, please check the controller or change probe.</p>
3D Controller USB	<p>Hardware error ; 3D imaging is not available Please contact a SuperSonic Imagine representative. The 3D controller USB is unplugged, please check the controller or change probe</p>
3D Controller Timeout	<p>Hardware error ; 3D imaging is not available Please contact a SuperSonic Imagine representative. The 3D controller is not responding, please check the controller or change probe</p>
3D Acquisition memory	<p>Memory error ; 3D acquisition requires more memory than is available Please contact a SuperSonic Imagine representative. Try to change acquisition parameters</p>
CPU processor temperature	<p><b>ERROR</b> Temperature is too hot on processor</p>
Graphic card temperature	<p><b>ERROR</b> Temperature is too hot on Graphic card</p>
Hard drive temperature	<p><b>ERROR</b> Temperature is too hot on Hard disk</p>
Image review	<p>Review error : Image cannot be loaded due to corrupted date You will be redirected to Bmode</p>

Alarm Condition	Message
IRQ Timeout DMA export	DMA sequencing warning – 0x000001 You many unfreeze to continue.
IRQ Timeout DMA import	DMA sequencing warning – 0x000002 You many unfreeze to continue.
IRQ Timeout	DMA sequencing warning – 0x000003 You many unfreeze to continue.
No active exam for Report	No exam in progress. You cannot access the report
PCI bus temperature	ERROR Temperature from SuperIO is too hot
Serial temperature	ERROR Temperature is too hot on serial port
Too many/old jobs in joblist	The Job List contains more than 500 pending jobs, and/or some pending jobs older than one week. Please select and delete these jobs manually from the Job List

The following alarms display a message for a duration of time on the main monitor. These are of a low priority:

Alarm Condition	Message
Hard disk space	WARNING DISK ALMOST FULL Please delete data from your system
USB transfer	ERROR while transferring data to USB device



# 4 System Overview



# Description of the System

The Aixplorer® system is a cart-based ultrasound system composed of a central processing unit enclosed in a lower housing, an articulated control panel, a touch screen, a monitor and a variety of transducers.

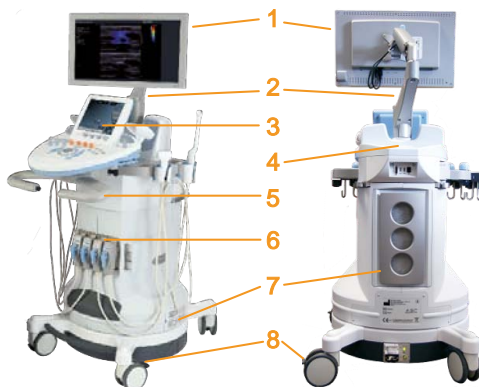

- |                 |                            |
|-----------------|----------------------------|
| 1. Monitor      | 2. Articulated monitor arm |
| 3. Touch screen | 4. Storage area            |
| 5. Handles      | 6. Transducer connectors   |
| 7. Air filters  | 8. Wheel locks             |



- |                |                 |
|----------------|-----------------|
| 1. Gel holders | 2. Touch screen |
| 3. Speakers    | 4. Trackball    |
| 5. TouchRing™  | 6. Hand rest    |

# Monitor and Articulated Arm

The monitor is mounted on an articulated arm that permits it to be positioned vertically and horizontally.

You can adjust the position of the monitor to suit different operating positions and operator heights.



When it is released from its locked transport position, the monitor can be tilted up and down, swiveled left and right, and moved from side to side.

To release the monitor from its locked transportation position, rotate the screw on the arm counterclockwise.

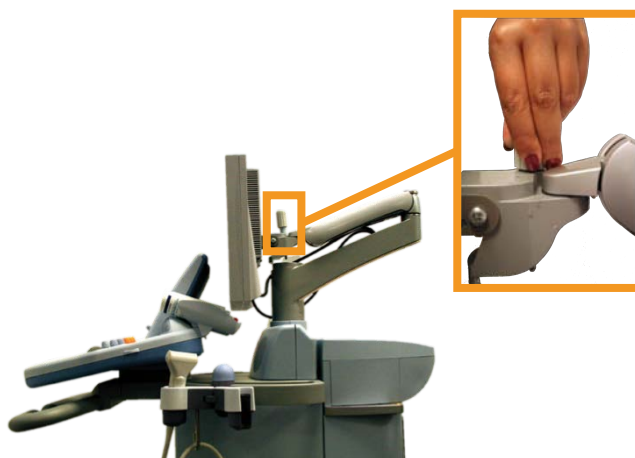

For transportation, put the monitor in its lower position and rotate the screw clockwise in order to lock the monitor in this position.

To adjust the monitor, simply grasp it by the sides and tilt, swivel or move it.



# Control Panel

## How to Move the Control Panel Up and Down

1. Push the button located on the tip of the right handle, as shown below:



2. Do one of the following, while the button is still pressed:
  - To push the control panel down, push the handle down
  - To lift the control panel up, just let it go up without pulling it

## How to Swivel the Control Panel

1. Pull the lever located under the control panel to unlock it
2. Rotate the control panel to the left or to the right for your convenience

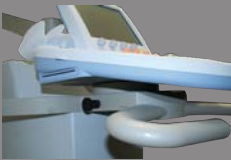

## Speakers and Audio Adjustment

The Audio Volume may be adjusted by rotating the knob with the speaker symbol located on the control panel, next to the on/off button.



## **CAUTION**

Do not get fluids into the speaker grills.

Be sure to clean any unused gel from the surface of the control panel after system use

Avoid placing fluids close to the speaker grills.

# Transducers

## Connecting a Transducer

### To connect a transducer:

Connect the transducer and turn the lock handle clockwise to lock the connector.



When disconnecting the transducer, turn the lock handle counterclockwise to unlock the connector and then hold the connector and pull it straight out.



### **CAUTION**

If a transducer is connected or disconnected with an image displayed, the system and/or the transducer may malfunction.

Do not connect or disconnect a transducer during the system startup or shutdown process. This may result in system malfunction.

If a transducer is dropped or other significant impact occurs, inspect the transducer carefully before use.

Verify that the transducer cover has not been cracked, and the cable and insulation are intact.

If there is any doubt of the integrity of the transducer, discontinue use and contact an authorized SuperSonic Imagine Service Representative.

## Storing a Transducer

When a transducer is not currently in use, you may want to store it on the system.

“Plug” the probe in the connector holder and place the probe in the probe holder.

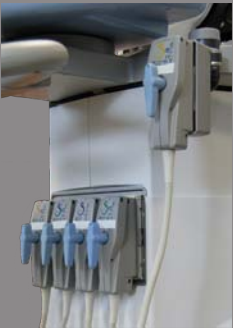

## Using the Cable Holder

### To mount the cable holder

1. Place the bottom part of the cable holder on the ring under the control panel
2. Use the screw to fix the cable holder





## To use the cable holder

1. Once the cable holder is mounted, insert the probe cable inside the two hooks
2. Place the cable on the top part before scanning



### NOTE

The cable holder is flexible for a comfortable scanning position.

## On-Cart Storage

### Gel Holders

On-cart gel holders have been provided as a convenience.

The gel holders are located on either side of the touchscreen.

Standard sized 250ml gel bottles may be placed in the holders for easy access during clinical exams.



### TIP

Place gel bottles in the holders with the nozzle down so that the gel is always ready to flow.



The gel holders are removable so they may be easily cleaned.  
Use warm water and a soft bristle brush to remove stubborn dried gel.

## Storage Area



This area may be used to store basic items such as notebooks, charts, DVD's and towels.



### **CAUTION**

Do not attempt to open the cart to attach devices.

Call your SuperSonic Imagine sales or service representative for assistance.

Incorrectly connecting electronic devices to the ultrasound system will void all warranties and may result in malfunction, electrical shock or fire.

Do not overload the system with peripheral devices.

Excessive loading of the system with peripherals, or stacking peripherals outside of the designated peripheral bay may cause system instability, resulting in the peripheral or system falling over.

# Mobility

The SuperSonic Imagine Aixplorer® ultrasound system is a transportable cart based system.

The chassis is mounted on four swivel wheels (casters) which allow you to easily roll the system over flat surfaces.

Swivel wheels allow the user to steer the system around corners.



## TIP

Pushing the system is much easier and safer than pulling it. Grasp the handles firmly and maintain an upright posture when pushing.

## Handles



Front mounted handles are provided to comfortably and safely grasp the system while moving.

Large handles mounted beneath the control panel allow the user to firmly and safely grasp the system when moving.

To steer the system, move the handles in the opposite direction you would like the cart to go (e.g. push handles to the right to steer the cart to the left).



## WARNING

The handles are not designed to be used to lift the system.

The handles are to be used only to push and pull the system.

To lift the system, it must be secured to a pallet, or be contained in its original shipping crate.

Do not use a hand-truck to move the system.

## Wheel Locks



Wheel locks are provided to stabilize the system when moving, scanning or when storing.

The wheel lock mechanism is located on each wheel.

The mechanism may be engaged by stepping on the black pedal.

Putting the pedal to the  position locks the wheel so that the system may no longer move freely.

Use this control to stabilize the cart prior to scanning.

Putting the pedal to the  position locks the wheel in direction so that the system can be moved forward and backward but cannot be rotated.

Putting the pedal to the  position unlocks the wheel and the system can be moved freely.

It is recommended that the wheels be locked when the system is unattended or stored in hallways or other areas where there is a risk of accidental bumping or collision.



### CAUTION

Wheel locks are not intended to stabilize the system on ramps or inclines.

Do not park or store the system on slopes or uneven surfaces.

## Foot Rests

Two foot rests have been provided for convenience.

They are located between and above the front wheels.

These rests provide an ergonomic option for resting the legs in a neutral position when scanning in a seated position.





# Moving the System

## Preparing to Move the System

1. Turn the system power off.
2. Unplug the main power cord, and disconnect any accessory cords (network, etc.).
3. Use the transducer cable management system to raise transducer cables up from wheel level.
4. Remove or ensure that all peripherals and items in the storage area are secure.
5. Lock the articulating monitor arm in its lowest position.
6. Unlock the wheel locks.

## Moving the System

1. Grasp the handles at the front of the machine firmly.
2. Keeping an upright posture, push the system forward.
3. Steer by moving the handles in the opposite direction you would like the cart to go (e.g. push handles to the right to steer the cart to the left).



### **WARNING**

Use caution when moving the system. It could cause injury to you or others if it rolls over feet or into shins.

Never attempt to lift the system manually.

In order to prevent injury, an aide such as a ramp or elevator must be used.

Exercise caution when going up or down ramps.

Do not push the system from either side with excessive force. The system could tip over.

Do not allow the wheels to roll over transducer or power cables.

If you encounter any failure of the wheels, handles or braking mechanisms, park the system on a level surface in a safe area, set the wheel locks and discontinue use until the mechanical parts can be inspected by an authorized SuperSonic Image Service representative.

# Connecting the Power Cable and Protective Earth



## WARNING

Be sure to connect the power plug to a three-pin grounded outlet meeting the ratings indicated on the rating name plate.

If this type of outlet is not available, contact your SuperSonic Imagine representative.

When the system is turned on, the color of the three LEDs located next to the main power switch indicates the following conditions:



LED	STATUS
Green	Normal operation
Yellow	High voltage fault
Blue or white	Power supply failure

When a yellow, blue or white LED is lit, please turn off the system and contact your Local SuperSonic Imagine representative.

Wait until the power supply **GREEN** LED is lit and not blinking before you turn the control panel on.

## Information concerning the terminal to which the potential equalization conductor is to be connected (⚡):

To use another medical device in combination with this system, an equipotential wire for connecting to an equipotential bus must be supplied. For more information, contact your SuperSonic Imagine representative. Be sure to connect the potential-equalization lead wire before inserting the equipment power plug into the receptacle. Also, be sure to remove the equipment power plug from the receptacle before disconnecting the wire to avoid electrical shock.

## Compatible Accessories and Kits

Under some use conditions, additional materials provided by third-party vendors may be used by clinicians performing exams with the system. The decision to use the system and transducers with third-party products is completely at the discretion of the clinician. The following tables list products which are suitable for use with the Aixplorer® system and transducers. The use of third-party products outside of those on the following lists is to be done at the user's and patient's own risk.

### Gels

Most water-based gels are compatible with the ultrasound system transducers.

The following gels are recommended because of their compatibility with our transducers. Please check whether the recommended products in the tables below are approved for use in your country.

Gel	Manufacturer
Aquasonic 100	Parker Laboratories, Inc

Gel	Manufacturer
Scangel	Monaco Cosmetique
Ultra/Phonic Conductivity	Pharmaceutical Innovations
Ultra/Phonic Free	Pharmaceutical Innovations



## WARNING

Use only recommended gels (lubricants). Alternate products can damage the probe and void the warranty

## Transducer Sheaths

Under certain conditions where the transducer may come in contact with mucous membranes, blood or other bodily fluids, the use of a transducer sheath is recommended.



## WARNING

The use of a transducer cover is recommended.

After use, the single-use sheath should be removed and discarded.

Endocavity probe should be used with a sterile sheath.

If these probes are used to assist biopsy procedures, all of the biopsy accessories should be sterile for the procedure and should be cleaned and resterilized according to manufacturer's recommendations, after each use.

The SE12-3 probe should be cleaned and received high level disinfection after use, even if a sterile sheath was used.

Sheaths can fail during use and the level of resulting contamination may not be easily visible.

The following tables list basic information regarding sterile transducer sheaths which will physically fit our ultrasonic transducers. Please check

whether the recommended products in the tables below are approved for use in your country.

## SL15-4



Transducer width 6.58 cm (2.6 in.), cable length 2.1 m (82.7 in.)

Manufacturer	Sterility	Latex/ Latex Free	Description	Serial Number	Dimensions
CIVCO	Sterile	Latex Free	CIV-Flex/ Telescopically Folded	610-637	8,9 x 91,5cm
CIVCO	Sterile	Latex Free	CIV-Flex/ Telescopically Folded	610-1000	10.2 x 147cm
CIVCO	Sterile	Latex Free	CIV-Flex/ Flat Folded	610-001	8.9 x 61cm
CIVCO	Non-Sterile	Latex Free	CIV- Flex/Flat Folded (3D)	610-362	14 x 61cm

## SC6-1



Transducer width 7.89 cm (3.11 in.), cable length 2.1 m (82.7 in.)

Manufacturer	Sterility	Latex/ Latex Free	Description	Serial Number	Dimensions
CIVCO	Sterile	Latex Free	CIV-Flex/ Telescopically Folded	610-637	8,9 x 91,5cm
CIVCO	Sterile	Latex Free	CIV-Flex/ Telescopically Folded	610-1000	10.2 x 147cm

Manufacturer	Sterility	Latex/ Latex Free	Description	Serial Number	Dimensions
CIVCO	Sterile	Latex Free	CIV-Flex/ Telescopically Folded (3D)	610-542	14 x 91.5cm
CIVCO	Non-Sterile	Latex Free	CIV- Flex/Flat Folded (3D)	610-362	14 x 61cm

## SE12-3

Transducer width at tip 2.42 cm (0.96 in.), transducer maximum width at handle 4 cm (1.58 in.), cable length 2.1 m (82.7 in.)



Manufacturer	Sterility	Latex/ Latex Free	Description	Serial Number	Dimensions
CIVCO	Sterile	Latex Free	CIV-Flex/ Flat Folded	610-006	11.9 tapered to 3.8 x 61cm
CIVCO	Non-sterile	Latex Free	CIV-Flex/ Flat Folded/ No Gel	610-007	11.9 tapered to 3.8 x 61cm
CIVCO	Sterile	Latex	Rolled	610-1199	3,5 x 20cm
CIVCO	Sterile	Latex	Neo-Guard	610-213	2,6 x 30cm
CIVCO	Sterile	Latex	Rolled/ Individual perforated packets	610-214	3,5 x 20cm
CIVCO	Sterile	Latex Free	Neo-Guard/ Rolled	610-843	2,6 x 30cm

For Brain perioperative application (available only for Europe), the endocavity probe must be used with one of these sheaths:

Manufacturer	Sterility	Latex/ Latex Free	Description	Serial Number	Dimensions
CIVCO	Sterile	Latex Free	Non- Pyrogenic	610-956	4.1 x 147 cm

Manufacturer	Sterility	Latex/ Latex Free	Description	Serial Number	Dimensions
			CIV-Flex intraoperative Transducer Cover		
CIVCO	Sterile	Latex Free	Non- Pyrogenic CIV-Flex intraoperative Transducer Cover	610-1107	10.2 x 147 cm
CIVCO	Sterile	Latex Free	Non- Pyrogenic NeoGuard intraoperative Transducer Cover	610-1118	15.2 x 244 cm

## SLV16-5



Transducer width 6.4cm (2.52 in.), cable length 2.1 m (82.7 in.)

Manufacturer	Sterility	Latex/ Latex Free	Description	Serial Number	Dimensions
CIVCO	Sterile	Latex Free	Surgi Intraoperative/ Accordion Folded/ No Gel	610-023	15,2 tapered to 7,6 x 244cm
CIVCO	Sterile	Ultra-Pro II Disposable Replacement Kit	CIV-Flex/ Telescopically Folded (3D)	610-608	14 x 91,5cm

All are CE approved as CE 0120. All are FDA approved:

- General purpose CIV-Flex Latex Free covers are under FDA K970513
- CIV-Flex 3D covers are under FDA K002546
- Neo-Guard, and Eclipse covers are under FDA K991236



- General Purpose Latex covers are under FDA K970515

## SL10-2



Transducer width 5.92 cm (2.33 in.), cable length 2.1 m (82.7 in.)

Manufacturer	Sterility	Latex/ Latex Free	Description	Serial Number	Dimensions
CIVCO	Sterile	Latex Free	CIV-Flex/ Flat Folded	610-323	6 x 91.5cm
CIVCO	Sterile	Latex Free	CIV-Flex/ Flat Folded	610-001	8,9 x 61cm

## SMC12-3



Transducer width at tip 0.91 cm (0.36 in.), transducer maximum width at handle 2.78 cm (1.09 in.), cable length 2.1 m (82.7 in.)

Manufacturer	Sterility	Latex/ Latex Free	Description	Serial Number	Dimensions
CIVCO	Sterile	Latex	Latex Pro/ Rolled	610-213	2,6 x 30cm
CIVCO	Sterile	Latex Free	Neo-Guard/ Rolled	610-1126	2 x 30cm
CIVCO	Non-sterile	Latex Free	Neo-Guard/ Rolled	610-838	4 x 30cm



## **LATEX TRANSDUCER SHEATHS**

Transducers may be sheathed in latex or latex-free sheaths for semi-critical applications. However, the use of latex sheaths for any procedure may involve the risk of an allergic reaction.

The following medical alert has been reprinted to inform the user of the possible risk of using latex sheaths.

FDA Medical Alert, March 29, 1991, Allergic Reactions to Latex-Containing Medical Devices (FDA MDA91-1)

Because of reports of severe allergic reactions to medical devices containing latex (natural rubber), the FDA is advising health care professionals to identify their latex sensitive patients and be prepared to treat allergic reactions promptly.

Patient reactions to latex have ranged from contact urticaria to systemic anaphylaxis.

Latex is a component of many medical devices, including surgical and examination gloves, catheters, intubation tubes, anesthesia masks, and dental dams.

Reports to the FDA of allergic reactions to latex-containing medical devices have increased lately.

One brand of latex cuffed enema tips was recently recalled after several patients died as a result of anaphylactoid reactions during barium enema procedures.

More reports of latex sensitivity have also been found in the medical literature.

Repeated exposure to latex both in medical devices and in other consumer products may be part of the reason that the prevalence of latex sensitivity appears to be increasing.

For example, it has been reported that 6% to 7% of surgical personnel and 18% to 40% of spina bifida patients are latex sensitive.

Proteins in the latex itself appear to be the primary source of the allergic reactions.

Although it is not known how much protein is likely to cause severe reactions, the FDA is working with manufacturers of latex- containing medical devices to make protein levels in their products as low as possible.

FDA's recommendations to health professionals in regard to this problem are as follows:

When taking general histories of patients, include questions about latex sensitivity.

For surgical and radiology patients, spina bifida patients and health care workers, this recommendation is especially important.

Questions about itching, rash or wheezing after wearing latex gloves or inflating a toy balloon may be useful.

Patients with positive histories should have their charts flagged.

If latex sensitivity is suspected, consider using devices made with alternative materials, such as plastic. For example, a health professional could wear a non-latex glove over the latex glove if the patient is sensitive.

If both the health professional and the patient are sensitive, a latex middle glove could be used. (Latex gloves labeled "Hypoallergenic" may not always prevent adverse reactions.)

Whenever latex-containing medical devices are used, especially when the latex comes in contact with mucous membranes, be alert to the possibility of an allergic reaction.

If an allergic reaction does occur and latex is suspected, advise the patient of a possible latex sensitivity and consider an immunologic evaluation.

Advise the patient to tell health professionals and emergency personnel about any known latex sensitivity before undergoing medical procedures.

Consider advising patients with severe latex sensitivity to wear a medical identification bracelet.

The FDA is asking health professionals to report incidents of adverse reactions to latex or other materials used in medical devices. (See the October 1990 FDA Drug Bulletin)

To report an incident, call the FDA Problem Reporting Program, operating through the U.S. Pharmacopeia toll-free number: 800-638-6725.

For questions about FDA activity related to latex sensitivity and anesthesiology, call the Office of Health Affairs, Center for Devices and Radiological Health, Rockville MD.

For a single copy of a reference list on latex sensitivity, write to: LATEX, FDA, HFZ-220, Rockville, MD 20857.

## Cleaning Solutions

See [Chapter 9, System Care & Maintenance\[377\]](#) for details regarding disinfection and cleaning and associated products.

## Printer Paper and Toner

See [Chapter 9, System Care & Maintenance\[377\]](#) for details regarding changing printer paper and toner and associated products.



### CAUTION

Additional equipment connected to medical electrical equipment must comply with the respective IEC or ISO standards (e.g. IEC 60950 for data processing equipment).

Furthermore all configurations shall comply with the requirements for medical electrical systems (see IEC 60601-1-1 or clause 16 of the 3rd Ed. of IEC 60601-1, respectively).

Any person connecting accessory equipment to medical electrical equipment is configuring a medical system and is therefore responsible that the system(s) complies with the requirements for medical electrical systems.

Attention is drawn to the fact that local laws take priority over the above mentioned requirements.

If in doubt, consult your local representative or the technical service department.

## Biopsy Guides

Biopsy guides are used during an ultrasound-guided biopsy exam, whose aim is to take a sample of tissue or fluid from a lesion.

The following biopsy kits may be used:

Probe	Manufacturer	Description	Serial Number
SL15-4	CIVCO	Infiniti plus in-plane guidance system	672-001
SC6-1	CIVCO	Ultra-Pro II needle guidance system	672-002
SE12-3	CIVCO	Disposable endocavity needle guide	657-014
SE12-3	CIVCO	Reusable endocavity needle guide	610-666

For an exhaustive list, please refer to the last applicable version of Civco catalog for SuperSonic Imagine.



# 5 Using the System





# Conventions

## Conventions Used in this User's Guide

This user's guide uses the following conventions:

All procedures are numbered. You must complete steps in the sequence they are presented to ensure a correct result.

Bulleted lists indicate general information about a particular function or procedure. They do not imply a sequential procedure.

Control names, menu items and/or titles are spelled as they are on the system.

Symbols appear as they appear on the system.

The left side of the system is to your left as you stand in front of the system, facing the system.

Touch means to press a button on the touch screen.

## Conventions Used in the System

These conventions are used in the system:

The software that runs the system uses graphic display elements similar to those used in many personal computers.

On a menu, or other display, a highlight bar indicates that the item or name contained within the boundaries of the highlight bar is in the process of being selected.



Pressing **Select** actually selects the item, assigns a value to a system parameter, or initiates the action related to the selected item

To enter text into a text field, move the cursor to the field and use the touch screen keyboard.

To display a list, click the down arrow.

To scroll through a list, make sure the pointer is over the list. Then use the **TouchRing™** to scroll. Moving your finger clockwise scrolls down a list, moving your finger counterclockwise scrolls up a list.



## Knobology

### Control Panel

Controls on the control panel include buttons, knobs, and knob-buttons.

Press a button to activate or deactivate its function.





Turn a knob to change the selected setting.

Press a knob-button to activate its function, turn it to change the selected setting.

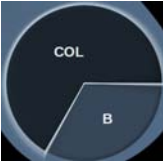
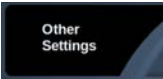
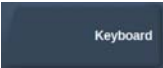

# Touch Screen

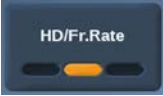
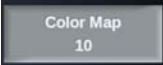
The touch screen contains several types of controls, depending on the function to perform.

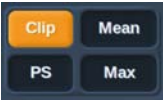
Touching this type of control...	... triggers this event
	<p>Touch a part of the wheel to display a different imaging mode menu.</p> <p>In this example, touching B displays a menu of controls associated with B-mode, but does not switch to B-mode.</p>
	<p>Touch Other Settings to display another page of controls associated with the current mode. For most imaging modes, 2 pages of settings are available.</p>
	<p>Touch to open a particular page or function. Touching the Keyboard control in this example displays the keyboard.</p>
	<p>Touch to turn a function On or Off. The LED button is orange when the function is on, and dark blue when it is Off.</p>
	<p>Touch to change the value displayed on the button.</p> <p>Repeatedly pressing this type of button cycles through all the values.</p> <p>The value displayed is indicated by the position of the orange mark.</p>
	<p>Rotate the knob located below the touch screen label to change the value.</p>
	<p>Touch to change the value displayed on the button. The value displayed is indicated in the box.</p>
	<p>Touch the appropriate part of the button to change its value.</p>

# Getting Started

## Turning the System On and Off

The system can be set to two different power modes: On and Off.

### Turning the System On

1. Press **I** on the switch located at the rear of the cart.

Wait until the power supply **GREEN** LED is lit and not blinking before you turn the control panel on.



## Powering the System Up



1. Press the **On/Off** button on the control panel, next to the left speaker. The system automatically checks a certain number of components and peripherals and boots up.

## Powering the System Down

1. Press the **On/Off** button on the control panel, next to the left speaker.
2. The shutdown menu appears.

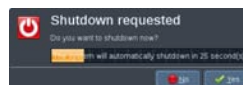

3. Select **Yes**.

## Turning the System Off

1. Press **0** on the switch located at the rear of the cart to complete the shutdown of the system.

If some elements are still in queue to be exported, the following shutdown menu appears:

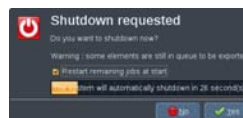

By default, the remaining jobs will restart at next start of the system. If you want to cancel the remaining jobs from the system, uncheck the box before shutting down the system.

When set to Off, the system consumes no power. To achieve a balance between convenience and energy efficiency, follow these recommendations:

- If the system will not be used overnight, switch the system to Off at the end of the day. Press the On/Off switch above the control panel to turn the system off.
- If the system will not be used for longer than overnight, power the system down. Press the On/Off button on the control panel to power the system down.

Always use the procedures listed here for turning off the system, if possible.

Turning off the system in any other way will result in longer initialization time when the system is turned on again, and may cause other problems.



## **CAUTION**

Turn on the system only after the power has been off for more than 15 seconds. If the system is turned on immediately after being turned off, the system may malfunction.

If power cannot be turned off by the normal procedure, press and hold down On/Off for at least 5 seconds. If the power is still not turned off, turn off the switch of the power supply panel at the rear of the system.

These methods should not be used under normal conditions. They may damage the system.

If the power is not turned off by following the normal procedures, B-mode images may not be displayed when the system power is turned on again. This does not indicate system failure. Turn off the switch on the power supply panel on the rear of the system, wait at least 15 seconds, and then turn the system power on.

Never shut down the system while files are being transferred. Data corruption or loss may result.



## **WARNING**

For emergency stop of the device, use the switch located at the bottom rear of Aixplorer®

## Setting the time and date

The system includes a clock/calendar function, which maintains accurate time and date even when the system is turned off and disconnected from power.

Refer to chapter [Chapter 8, \*Customizing the System\*\[337\]](#) for instructions on setting up time and date.

## Getting Connected to a Network

The system supports standard network functions, which include printing to DICOM printers, local printers and report printers (options).

Refer to [Chapter 8, \*Customizing the System\*\[337\]](#) for instructions on network configuration.

## Selecting a Transducer

The system uses four ports for connecting transducers that can be occupied at the same time, but only one transducer can be active at a time.

When a transducer is not in use, store it in one of the transducer holders. Always use the cable management system to prevent cables from being stepped on or run over by the cart wheels.



## Connecting a Transducer

See [the section called “Connecting a Transducer” \[111\]](#).



## Selecting a Transducer for an Exam

When the system is turned on, the system defaults to the last used transducer, application and preset.

It is possible to select among the four connected transducers during system operation.



1. Press **Probe** on the control panel.

The touch screen will display the applications that are compatible with the transducers that are connected to the system



2. Touch the **tab** corresponding to the desired clinical application.

Ex: Vascular

The touch screen will display the probes you can use for the selected application, and the associated Presets.

3. Press the desired **Preset**.

Ex: Carotid

The Probe touch screen closes and the system is in live B-mode.

The factory presets appear in darker blue and the user-created presets appear in lighter blue.



### NOTE

It is possible to customize the displayed list of presets in the system configuration. Refer to [Chapter 8, Customizing the System \[337\]](#)

The selected transducer, application and preset appear on the header of the imaging main display.



## WARNING

Use only recommended gels (lubricants). Alternate products can damage the probe and void the warranty.

## Beginning an Exam

### Getting Ready

Before acquiring images, you may want to create a patient exam or retrieve a patient you already created in the system.

Before scanning a new patient, make sure the previous exam has been ended, by doing one of the following:

- Press **End Exam** on the control panel.
- Press **New Patient** on the touch screen.

### Creating a New Patient

#### PATIENT DATA ENTRY

1. Press **Patient** on the control panel.  
The Patient Data Entry is displayed on the main screen.



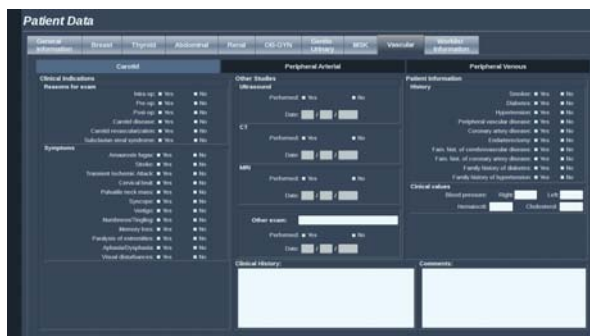

The **General Information** tab of the Patient Data Entry gathers the fields related to the patient identity.

The **Worklist** Information tab of the Patient Data Entry displays information coming from the Modality Worklist (if associated and configured).

Eight other **tabs** are available, each of them displaying specific clinical information:

- Breast
- Thyroid
- Abdominal
- Renal
- OB-GYN
- Genitourinary
- MSK
- Vascular

To navigate through the tabs:

1. move the cursor to the tab you want to open, and press **Select** on the control panel.
2. Place the text cursor in the field you want to enter data.  
The active field is highlighted in orange.
3. Type the desired text with the keyboard.



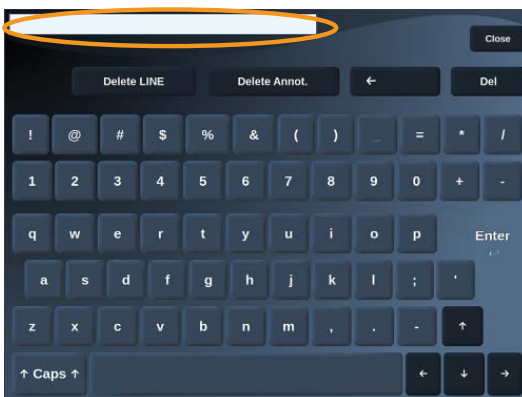

You can visualize the text you are currently typing directly on the touch screen, in the preview area.



## NOTE

**Patient ID:** The system uses a unique ID to identify each patient. You may enter your own ID, or the system will create one automatically. Images and reports are stored based on the patient ID.

The name and ID appear at the top of all image displays.

## TO CHOOSE A VALUE IN A LIST:

1. Move the cursor to the arrow on the right of the drop-down list.
2. Press **Select** to display the list.
3. Move the cursor down to the selected value and press **Select** again to validate your choice.



You can save the Patient Data Entry as an image of the exam. To do so, press **Save Image** while in the Patient Data Entry. This will save the active tab as a screenshot.

# Loading a Patient file from the Modality Worklist

## FINDING EXAMS IN THE WORKLIST

This feature is available if the system is connected to the network and the DICOM feature is enabled.

1. Press **Patient** on the control panel.

The Patient Data Entry is displayed on the main screen.

The Patient touch screen is now displayed.



### NOTE

If a Modality Worklist is configured and associated, pressing **End Exam** will automatically display the Modality Worklist (if configured).

2. Touch **M.Worklist** on the touch screen.

The modality worklist is displayed on the main screen.

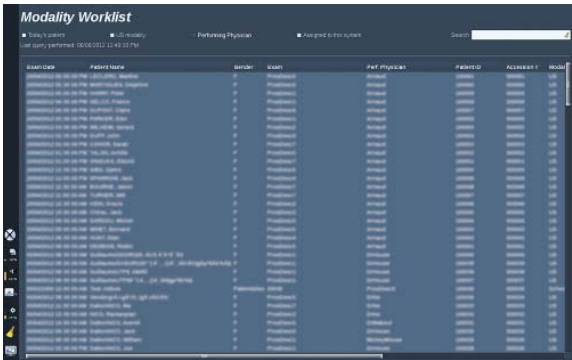

### NOTE

Check the boxes above the list to filter it.

Place the **Pointer** over a column header and then press **Select** to sort the list by the selected column.

Use the search box to find a given patient.

3. Move the cursor over the patient file you want to open.
4. Press **Select** on the control panel.

The Patient Data Entry is displayed on the main screen and pre-populated.

You can edit some of the information for this patient.

See [Chapter 8, Customizing the System\[337\]](#) for more information on how to configure the Modality Worklist.

## BROAD QUERY, PATIENT QUERY

Aixplorer® offers the two types of queries defined by the IHE (Integrating the Healthcare Enterprise): broad queries and patient queries.

By default, the Worklist performs broad queries.

**Patient Query** limits the number of answers that are returned, and therefore increases the confidentiality, limits the risk to select by mistake the wrong patient in the worklist, and limits the quantity of data to be transferred to the system.

To use Patient Query:

1. Press **Patient Query** on the touch screen to perform a query on a specific patient only. Use this mode especially if your network is slow.

A window pops up.



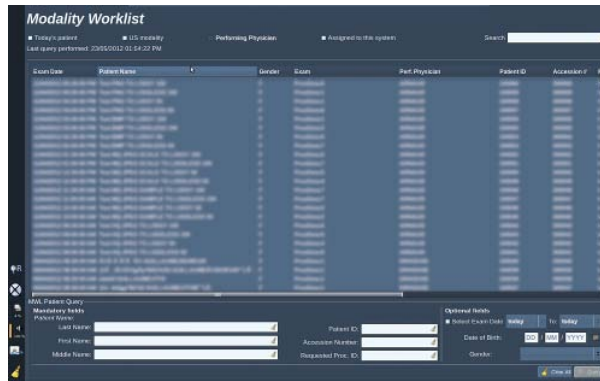

2. Enter data for the specific patient you want to retrieve on the worklist. At least one mandatory field must be filled in to perform the query.
3. Click on **Query** to perform the query on the specific patient.

Press **Broad Query** on the touch screen to switch to the Broad Worklist query mode.

The Modality Worklist can be used when the system is disconnected from the network. See [Chapter 8, Customizing the System\[337\]](#) for more details.



## Editing Patient Data

### EDITABLE DATA

Data may be edited for the current patient. Some information can be edited at any time during an exam, if not imported from the Modality Worklist.

### TO EDIT PATIENT DATA

1. Place the text cursor in the field you want to edit.

The active field is highlighted in orange.

2. Type the new text with the keyboard.

If you edit one of the identifier fields, a pop up message is displayed. Press **Yes** to confirm or **No** to cancel.

The identifier fields are the following:

- Patient Last Name
- Patient First Name
- Patient Middle Name
- Patient ID
- Accession Number
- All the fields in the DICOM tab of the Patient Data Entry



## NOTE

If you edit one of the fields listed above **AFTER** the exam was sent to a server, the DICOM store may start a new exam with the new patient information.

Entering the patient's height and weight automatically calculates the Body Mass Index (BMI).

## Ending an Exam

Make sure all the images you need are saved.

After the exam is complete, end the exam as follows:

Press **End Exam** on the control panel.





# Imaging Modes

## General Information on Imaging Modes

### Entering/Exiting Modes

The Aixplorer® ultrasound system offers a set of imaging modes via the mode selection buttons.

On the control panel, the mode buttons (orange) are located below the touch screen.



- Press **B** to scan in grayscale B-mode.
- Press **SWE™** to scan in grayscale B-mode with a real-time color elasticity map superimposed.
- Press **COL** to use Color Flow Imaging (CFI), Color Power Imaging (CPI), or Directional Color Power imaging (DCPI)
- Press **PW** to use Pulsed Wave Doppler
- Press **CEUS** to use Contrast Enhanced Ultrasound imaging



## NOTE

Access to 3D and M modes is given on the touch screen.

In any mode other than B-mode, whenever the **B** key is pressed, the current mode is exited and B-mode is displayed.

The previous settings are restored.

## About the Imaging Main Display

The imaging main display contains an ultrasound image, the exam and image information and some indicators.

The image area is located approximately in the center of the imaging display.

To the right of the image itself are a depth scale and a grayscale bar and/or color bar.

Patient and exam data are displayed in the area directly above the ultrasound image. This area also includes the current time and date, the institution name, the selected transducer and clinical application, the Thermal Index (TI) and Mechanical Index (MI) values.

Image parameters are displayed on the left of the image.

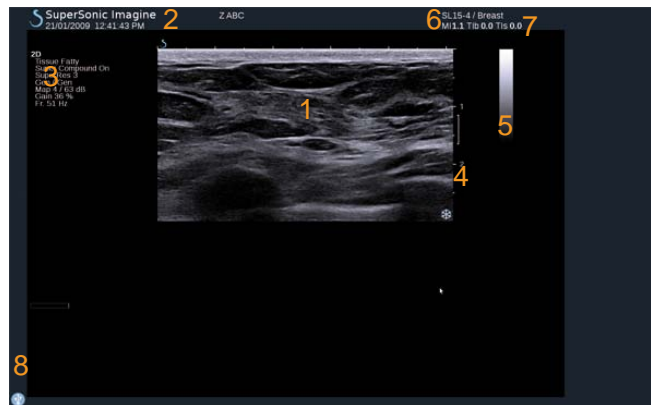





























- |                     |                       |
|---------------------|-----------------------|
| 1. Ultrasound image | 2. Patient/Exam data  |
| 3. Image Parameters | 4. Depth scale        |
| 5. Grayscale bar    | 6. Transducer/Preset  |
| 7. MI and TI        | 8. Notification icons |

Refer to each mode for a detailed description of each imaging main display.

## Notification Icons

Some icons appear at the bottom left of the main display to inform you about the state of the system.

Icon	Meaning
	There is a CD in the CD/DVD drive
	The system is burning a CD
	Error during CD burning
	There is a DVD in the CD/DVD drive
	The system is burning a DVD
	Error during DVD burning
	No CD or DVD in the CD/DVD drive
	There is a USB device plugged in
	The system is exporting data to a USB device
	Error during USB export
	The system is connected to a network
	Network error
	The system is exporting data to a DICOM store SCP
	Error with the DICOM Modality Worklist SCP

Icon	Meaning
	Error with the DICOM Store SCP
	The system is printing to a DICOM printer
	Error with a DICOM printer
	Error with a DICOM commit server
	The system is printing to a local printer
	Error with a local printer
	Modality Performed Procedure Step (MPPS) is busy
	Error with MPPS
	DICOM Modality Worklist is refreshing
	Error with DICOM Modality Worklist
	DICOM Modality Worklist: Offline mode
	DICOM Modality Worklist filtered
	Check the air filters
	Available storage on the hard drive
	Query and Retrieve

# About the Imaging touch screen

The imaging touch screen varies according to the scanning mode.

It contains:

- permanent controls available in all imaging modes
- imaging parameters that are related to the current active mode(s)
- rotary controls that can be used with their corresponding knobs, located under the touch screen
- a navigation wheel that allows you to change parameters for all the active modes

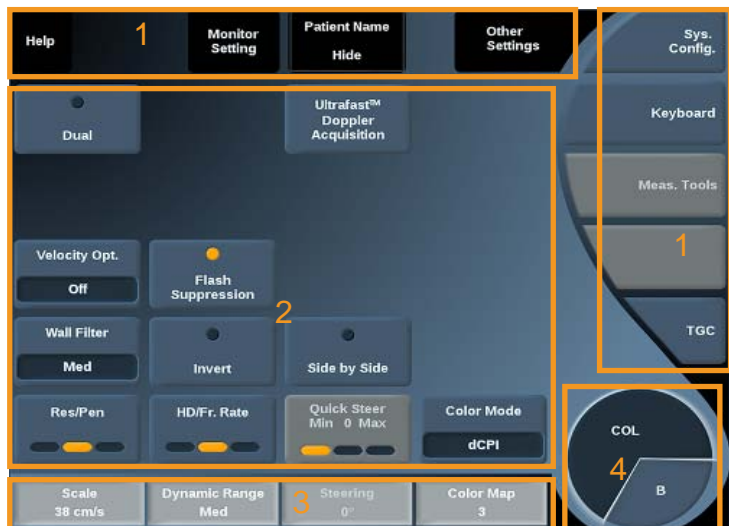

1. Permanent controls
2. Imaging parameters
3. Rotary controls
4. Navigation wheel

Refer to each imaging mode to have a detailed overview of the parameters.

# Common Imaging Controls

Some controls are common to all imaging modes. These controls are detailed below.

For a description of controls specific to each imaging mode, refer to the detailed section on each imaging mode.

## Freeze



When in Live imaging, press **Freeze** on the control panel to freeze the image. A snowflake appears on the image to indicate the image is frozen.

When the image is frozen, press **Freeze** to unfreeze the image and return to live imaging.

## Depth



**Depth** controls the distance over which the B-mode displays anatomy. When you increase the depth, you capture echoes from deeper in the body. Therefore, it takes longer for the transducer to receive all the signal. The receive time is increased and there is more information to process. The time between two ultrasound beams is increased.

As a result, the frame rate is decreased.

**Depth** is adjustable only in live imaging.

**Depth** is located on the control panel.

Rotate **Depth**:

- clockwise to increase the depth and visualize deeper structures
- counterclockwise to reduce the depth and focus on shallower structures.

Depth increments vary by application and mode.

Depth is displayed on the imaging display in centimeters.

## Gain

Overall gain increases or decreases the amount of echo information displayed in an image.

It may have the effect of brightening or darkening the image if sufficient echo information is generated.

Gain is adjustable in live imaging and on a frozen image.

Gain is adjustable in all modes with each mode knob.

Rotate **B**, **SWE™**, **COL** or **PW** according to the active mode:

- clockwise to increase the overall gain in order to obtain a brighter image
- counterclockwise to decrease the overall gain in order to obtain a darker image.

## Time Gain Compensation (TGC)

### AUTOTGC

**AutoTGC** automatically adjusts the B-mode gain at different depths and for different tissue attenuations.

Overall brightness is automatically adjusted depending on setting of **AutoTGC Offset** (see [the section called “AutoTGC Offset” \[168\]](#)).

**AutoTGC** is located on the control panel.

Press **AutoTGC**. If needed, you can make independent gain adjustments (see [the section called “Gain” \[156\]](#) above).



### NOTE

While in PW mode, press **AutoTGC** to automatically adjust the **Scale** and **Baseline**. See [the section called “Setting Up PW” \[211\]](#)





## MANUALTOUCHTGC™



You can selectively adjust the uniformity of brightness throughout the image.

Press **TGC** on the touch screen.

The B-mode image is simultaneously displayed behind the slide pods.

Draw the TGC curve as needed with a stylus or finger.

You can also change the position of each virtual control on its line by touching another place on the same line.

## Transmit Focal Zone



The focal zone is the depth at which the lateral resolution is the best on the image.

The focal position is the depth at which the transmitted ultrasound energy is focused.

**Focus** is adjustable only on live imaging.

**Focus** is located on the control panel.

Rotate **Focus**:

- clockwise to place the focal zone deeper
- counterclockwise to place the focal zone at a shallower depth

Press **Focus** and then rotate it:

- clockwise to increase the size of the focal zone
- counterclockwise to decrease the size of the focal zone

Press **Focus** again to move the focal zone.

Changing the size of the focal zone affects the frame rate.

The larger the focal zone, the slower the frame rate.



## Zoom

A region of interest in imaging modes can be magnified for closer examination. Two types of zoom are available on Aixplorer®: HD Zoom and Digital Zoom.

### HD ZOOM

HD Zoom concentrates the system acquisition and processing ability on a specific region of interest in the real-time image display.

The result is a reduced field of view overall, but greater detail and higher frame rate, which contribute to better image quality over the region of interest.

**HD Zoom** is adjustable only in live imaging.

To use the **HD Zoom** function:

1. Press **Zoom** on the control panel  
A box appears on the image.
2. Use the **trackball** to move the zoom box
3. Press **Select** to arbitrate the trackball to Box size
4. Use the **trackball** to resize the zoom box
5. Press **Zoom** again to have an enlarged image
6. Press **Zoom** again to exit zoom

### DIGITAL ZOOM

**Digital Zoom** is a magnifying post-processing function. As such, it has no effect on the frame rate.

**Digital Zoom** is adjustable in live imaging and on a frozen image.

Rotate **Zoom**:

- clockwise to increase the zoom factor
- counterclockwise to decrease the zoom factor



## NOTE

In live imaging, both HD Zoom and Digital zoom may be used at the same time.

## Left/Right

**Left/Right** flips the image along the left-right axis.

Touch **Left/Right** to flip the image.



## Top/Bottom

**Top/Bottom** flips the image along the up-down axis.

Touch **Top/Bottom** to flip the image.



## Dual

Touch **Dual** to activate or deactivate dual mode.

The left image will be active.

Press **Select** to freeze the left side of the image and make the right side active.





Press **Freeze** to have both sides frozen.

- the active image has an orange S as the orientation marker
- the inactive image has a white S as the orientation marker

You can switch which of the dual images is active by pressing **Select**. Imaging settings will always be applied to the active image in dual. Imaging settings will be maintained independently for the dual images. If you press **Freeze** before **Select**, you can change image settings and modes on the active side.

## Dual Top/Bottom

**Dual Top/Bottom** is the same feature as **Dual**, but split the screen into a top image and a bottom image.

1. Press **Dual** to enable **Dual Top/Bottom**.
2. Press **Dual Top/Bottom** to activate or deactivate the **Dual Top/Bottom** display format.



## Play

When the image is frozen, in all modes, a **Play** button appears on the touch screen.

**Play** allows you to view clips. See [Chapter 7, Image and Data Management \[309\]](#) for more information on viewing clips.



## Hide Patient Name

**Hide Patient Name** allows you to temporarily hide the patient information from the imaging screen. However, the hidden information remain in the database.



## Trackball Arbitration

If several functions are available with the trackball, they are displayed at the bottom of the image. The active function is displayed in orange.

Press the **Pointer** to change the active trackball function.



Press **Select** to change between **Box move** (position of the box) and **Box size** (resize the box).

Press **Select** to switch between **Img1** and **Img2** in dual displays.

## Monitor Setting

On each imaging mode touch screen page, a **Monitor Setting** button allows you to select your monitor profile.

1. Press **Monitor Setting** on the touch screen  
A monitor setting page is displayed on the touch screen.
2. Rotate the **Monitor Profile** knob until you reach the desired setting.

Press **Monitor Profiles Factory Default** to reset the monitor profile back to the factory setting.





## B-Mode Imaging

B-Mode is an ultrasound imaging mode which allows you to assess two-dimensional anatomy by displaying the echoes returning from tissues of different density in various shades of gray.

### Accessing B-mode

Press **B** on the control panel from any other modes.



### About B-Mode Main Display

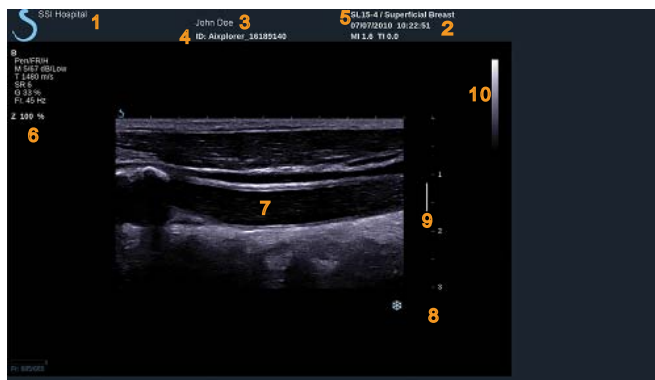

- |                             |                       |
|-----------------------------|-----------------------|
| 1. institution name         | 2. date and time      |
| 3. patient name             | 4. patient ID         |
| 5. transducer/Preset/ MI/TI | 6. imaging parameters |
| 7. ultrasound image         | 8. depth scale        |
| 9. focal zone               | 10. grayscale         |

## About B-Mode touch screen

When in B-mode, the touch screen displays various image controls which help you to optimize your B-mode image.

There are two pages of B-mode parameters. These settings are controlled by touching the control on the touch screen, or by turning the rotary knob directly below the touch screen.



You can navigate through the pages by touching **Other Settings**.



# Description of B-mode Imaging Parameters

## HARMONIC IMAGING

Harmonic imaging mode is used to reduce image clutter and reverberation, and enhance borders.

Harmonic imaging is available only in live imaging.

Press **Harmonic Imaging** to activate/deactivate harmonic imaging.



## RES/PEN

**Res/Pen** allows you to change center frequency to obtain increased resolution or increased penetration. **Res/Pen** is available only in live imaging. Press **Res/Pen** to change value.

The orange LED indicates which one is the active value:

- Left LED: Res (resolution)
- Middle LED: Gen (general)
- Right LED: Pen (penetration)



## HD/FR. RATE

**HD/Fr. Rate** allows you to adjust frame rate and line density to achieve increased spatial or temporal resolution.

Touch **HD/Fr. Rate** to change value.

There are three options to choose from:

- HD (High Definition): left LED
- Balanced: middle LED
- Fr. Rate (Frame Rate): right LED





## TISSUETUNER™

**TissueTuner™** allows you to adjust the receive parameters associated with the assumed speed of sound of ultrasound in the body. Adjusting the speed of sound parameter to match the type of tissue being interrogated results in increased spatial and lateral resolution.

**TissueTuner™** is available only in live imaging.

Rotate the knob located under **TissueTuner™**:

- clockwise for a denser tissue (higher speed of sound values)
- counterclockwise for a less dense tissue (lower speed of sound values)

**TissueTuner™** values depend on the selected application.



## DYNAMIC RANGE

**Dynamic Range** Dynamic Range allows you to change the range over which the amplitudes of returning ultrasound signals are displayed.

**Dynamic Range** is available in live imaging and on a frozen image.

Rotate the rotary knob located under **Dynamic Range**:

- clockwise to compress the grayscale values
- counterclockwise to decrease the dynamic range

**Dynamic range** values depend on the selected application.



## 2D MAP

**2D Map** assigns the display of echo amplitudes to a range of grayscale or chromatic colors.

**2D Map** is available in live imaging and on a frozen image.

Rotate the rotary knob located under **2D Map**:

- clockwise to view next map
- counterclockwise to view previous map

There are 7 maps available.

## SUPERCOMPOUND™

**SuperCompound** combines the returning ultrasound from a large number of steered echo lines to create an image which provides superior texture, enhanced edge delineation and reduces shadowing. SuperCompound is available in live imaging only.

Press **SuperCompound** to activate or deactivate the SuperCompound mode.



## ACOUSTIC POWER

**Acoustic Power** regulates the output power of the system.

**Acoustic Power** is available only in live imaging.

Rotate the knob located under **Acoustic Power**:

- clockwise to increase acoustic power output
- counterclockwise to decrease acoustic power output

Maximum acoustic power is 0dB and minimum is -30dB.

See [Chapter 3, Safety \[27\]](#) for information on output power regulations.



## PRF

**PRF** allows you to change the pulse repetition frequency for the B-mode image.

Decreasing the PRF may correct the reverberation artefacts.

Rotate the knob located under **PRF** to change its value.



## AUTOTGC OFFSET



**AutoTGC offset** allows you to program automatic overall gain when using the **AutoTGC**.

AutoTGC Offset is located on the second page of parameters.

Rotate the knob located under **AutoTGC offset**:

- clockwise if you prefer a brighter image
- counterclockwise if you prefer a darker image

## PERSISTENCE



This frame averaging technique reduces noise on the image.

**Persistence** is available in live imaging and on a frozen image (to view clips).

Rotate the rotary knob located under **Persistence**:

- clockwise to increase persistence
- counterclockwise to decrease persistence

## SUPERRES™



**SuperRes™** is an image processing feature which reduces speckle, improves image texture and enhances borders without an impact on frame rate.

**SuperRes** is available in live imaging and on a frozen image.

Rotate the rotary knob located under **SuperRes**:

- clockwise to increase **SuperRes**
- counterclockwise to decrease **SuperRes**

**SuperRes** values depend on whether **SuperCompound** is On or Off.

## SECTOR SIZE



**Sector Size** widens or narrows the size of the sector angle to maximize the image's region of interest. Changing the sector size affects the frame rate. The narrower the sector size, the faster the frame rate.

## TRAPEZOID



**Trapezoid** allows you to increase the field of view. Press **Trapezoid** to activate/deactivate the trapezoidal mode.

## Biopsy

Biopsy guides are used to assist in the guidance of a biopsy tool. The system generates a guideline that represents the anticipated path of the biopsy tool.

See [the section called “Compatible Accessories and Kits” \[120\]](#) for the list of compatible biopsy kits.

## ATTACHING AND REMOVING A BIOPSY GUIDE



### **WARNING**

Inspect all components and the transducer.

Ensure that the biopsy guide you are using is the correct one for the transducer, the system, and system software.

Some biopsy guides must be installed over a sterile transducer cover. Refer to the instructions provided with the biopsy guide.

After each use, biopsy guides must be either sterilized or disposed of, depending upon the type. Refer to the instructions included with the biopsy guide.

Refer to the biopsy kit instructions on how to attach the biopsy guide on the probe.

## INSTRUCTIONS FOR THE USAGE OF THE BIOPSY GUIDELINE

The Aixplorer® generates two biopsy guide lines which are the “lines” shown on the ultrasound image.

The displayed guide lines indicate the anticipated path of the needle, and should not be used as a standard in which the needle must lie within the two guide lines.

Please understand that the biopsy guide lines displayed do not indicate the exact location of the needle when performing the biopsy.



### **WARNING**

Make sure you correctly adjust the TissueTuner before performing a biopsy. The ideal TissueTuner setting results in a sharply resolved image, which improves needle guidance.



### **CAUTION**

When the biopsy is on, the auto-freeze time is disabled in B-mode.

Make sure to turn the biopsy off after the procedure is complete, to avoid damaging the probe.



The biopsy guideline is available for the SC6-1 and SE12-3 probes.

1. Scan in B-mode and optimize the image as needed
2. Locate the area to biopsy
3. Press **Biopsy** on the touch screen

**Biopsy Angle** and **Hide Biopsy** are activated (un-grayed). The biopsy guidelines appear on the screen.

1. Press **Biopsy Angle** until the desired biopsy angle is displayed on the button
2. Use the **Trackball** to move the biopsy target along the guidelines
3. Perform the biopsy

**Biopsy Steering** allows you to steer the ultrasound image in order to enhance the needle visualization during a biopsy procedure.

The **Biopsy Steering** control is available in the breast application for the SL15-4 and SL10-2 probes.

If the needle is introduced from the right side of the transducer, press **Biopsy Steering** until **Right** is selected.

If the needle is introduced from the left side of the transducer, press **Biopsy Steering** until **Left** is selected.

## Panoramic

Panoramic imaging registers individual frames as the transducer is moved along a structure of interest and superimposes the registered frames to generate a composite image, allowing the visualization and measurement of large structures of interest that would not fit within the transducer's field of view.



### TIP

Use adequate quantities of gel along the entire segment to be scanned to ensure smooth motion during the panoramic acquisition.

## ENTERING PANORAMIC IMAGING

Panoramic imaging is available for the SL15-4 and SL10-2 probes.

Press **Panoramic** on the touch screen.  
The system enters the Panoramic Stand-by stage.







## ACQUIRING PANORAMIC IMAGES

1. Adjust the available imaging parameters to optimize image quality and frame rate.
2. Press **Select** to start the acquisition.



### NOTE

You can configure the **S** key to start the panoramic acquisition in the system configuration.

3. Move the probe in a smooth and continuous manner along the structure of interest, making sure that the scanning motion is as much as possible parallel to the scan plane.  
The system automatically detects the probe's motion direction and the composite image is being created accordingly.
4. If needed, scan backwards to erase unwanted parts of the panoramic composite image, then resume scanning along the original motion direction.
5. Press **Freeze**.  
The system displays the whole composite image.



## SCANNING RECOMMENDATIONS

- Ensure that the scanned surface is flat or gently curved, and avoid tissue areas dominated by noise or lacking structural details
- Use plenty of gel and apply sufficient (but not excessive) transducer pressure, to ensure good contact with the skin throughout the Panoramic acquisition.
- Use a slow and steady scanning motion without wobbling, twisting or abrupt changes in the scanning direction, staying within the same scan plane as much as possible.



## WARNING

- Panoramic registration errors are manifested by the presence of artifacts such as image gaps, irregular skin line contours and jagged

edges, clearly visible “seams” between successive input image frames,, and blurred or poorly defined areas. If such artifacts are encountered, it is strongly recommended to discard the current Panoramic composite image and repeat the Panoramic acquisition.

### Notes:

- All measurements derived from a Panoramic composite image are marked by an asterisk, to indicate that they represent estimated measurement results and may have been affected by Panoramic registration errors.
- When the structure to be measured can fit within the transducer's field of view, it is strongly recommended to use a standard B-mode image frame and not the Panoramic composite image.

## MANIPULATING PANORAMIC IMAGES

### Display



Use the **Zoom** functionality as for regular B-mode.

Use the **Pan** functionality as for regular B-mode.

Use the **Rotate** button or **TouchRing™** to rotate the panoramic composite image.

Use the **Smoothing** knob to soften abrupt transitions between input frames in the Panoramic composite image.

### Trim



**Trim** allows you to discard frames from the start or end of the panoramic acquisition, so that they don't contribute to the panoramic composite image.

1. Press Trim on the touch screen to start trimming  
The trackball is arbitrated to **Trim Start**.
2. Move the trackball towards the end of the panoramic acquisition to discard the required frames from the start of the acquisition.

3. Press **Select** to arbitrate the Trackball to Trim End.
4. Move the trackball towards the start of the panoramic acquisition to discard the required frames from the end of the acquisition.
5. Turn **Trim** off to cut the trimmed frames out.

The remaining panoramic composite image will be automatically zoomed to fit on the screen.

Press **Trim Reset** to return the Trim Start and Trim End frames to the start and end of the panoramic acquisition, respectively.

## Skinline Tick-Marks

**Skinline Tick-Marks** allows you to display or hide the tickmarks along the skinline.

Press **Skinline Tick-Marks** to activate/deactivate the skinline tickmarks.



## Smoothing

**Smoothing** is a spatial filter used to smooth the panoramic image in order to provide a more homogeneous appearance.

Rotate the knob located under **Smoothing**:

- clockwise to increase smoothing
- counterclockwise to decrease smoothing



## PERFORMING MEASUREMENTS ON PANORAMIC IMAGES

Press **Meas.** on the control panel to access measurements available in panoramic imaging.





## WARNING

- Do not perform measurements on Panoramic composite images acquired with substantial out-of-plane motion components (such as when following a tortuous structure).
- Do not perform measurements across structures which appear as strongly hypoechoic or very noisy in the Panoramic composite image.
- Do not perform measurements on Panoramic composite images of highly-curved objects such as transverse sections through the arm or leg.

Basic measurements (distance, ellipse, trace, ...) on a Panoramic composite image are performed as in standard B-mode. Please refer to [the section called “Basic Measurements”\[254\]](#) for a description of such measurements.

## Curved Distance Measurements

You can measure the distance of a curve on a panoramic image. The Curved Distance measurement tool is similar to the Trace measurement tool, but the curved distance trace is not closed. The Curved Distance measurement tool provides a distance measurement result.

To perform a Curved distance measurement:

1. Acquire the panoramic image
2. Press **Meas.** on the Control Panel
3. Press **Curved Distance** on the touch screen  
A first caliper is displayed.
4. Move the first caliper at the desired location
5. Press **Select** to anchor the first caliper
6. Move the **Trackball** to start tracing the curve
7. Use the Trace knob to erase the trace if needed
8. Press **Select** to complete the measurement  
The system displays the curved distance measurement result in the measurement result area.



## SAVING PANORAMIC IMAGES

Press **Save Image** to store the current Panoramic composite image so that it can be reviewed, manipulated, trimmed and measured at a later time.

## EXITING PANORAMIC IMAGING

Press the **Panoramic** button on the touch screen to turn it off and exit panoramic imaging.

# Pulse Wave Velocity (PWV)

PWV allows you to measure the Pulse Wave Velocity (PWV) on the carotid artery.

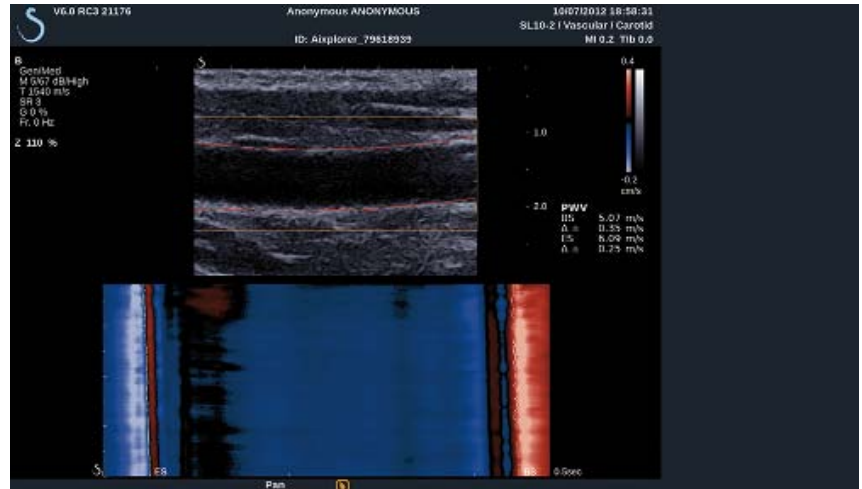

The pulse wave velocity linked to the arterial stiffness, which is used as an indicator of potential future cardiovascular events. The blood pressure wave generated by each heart beat in systole is propagating along the entire arterial tree in the form of the so-called “pulse wave”. The propagation speed of this “pulse wave” (the “Pulse Wave Velocity”, or “PWV”) is strongly related to the stiffness of the arterial wall. The stiffer the arterial wall, the faster the pulse wave.



## TIP

To ensure a stable arterial pressure, make sure the patient is at rest.

Obtain a longitudinal view of the carotid as far as possible from the carotid bifurcation.

Carefully align the arterial walls with the probe skin-line. To ensure a correct alignment of the probe in the elevation plane, ensure that the intima-media complex is visible on the image.

## HOW TO USE PWV

### Acquisition



1. Select the **carotid preset** in the vascular application
2. Scan in B-mode to locate the carotid and obtain a longitudinal view of the carotid
3. When probe is aligned and the imaging plane steady, press **PWV** on the touch screen to perform the acquisition



### NOTE

you can configure the **S** key to start the PWV acquisition in the system configuration.

4. Do not move until the acquisition is complete

### Post-processing



1. When the acquisition is complete, a box is displayed on the image.
2. Use the **Trackball** to position the box on the carotid  
The system automatically detect the arterial walls within the box.  
In some cases, you might need to resize the box:
  - a. press **Pointer** to arbitrate the Trackball to **Resize** and use the **Trackball** to resize the box.
3. Press **Select** to validate the segmentation



The system automatically detects and tracks the pulse wave and display below the B-mode image:

- a color-coded map of the diameter variations (in cm/s) over time (seconds) and along the arterial segment (in mm) respectively horizontal and vertical axis

- the detected wavefronts in early and late systole are displayed superimposed to the color coded map of the diameter variation as well as their linear fit used to derive PWV
- the measured pulse wave velocity in beginning of systole (BS) and end of systole (ES) in m/s as well the variance ( $\Delta$ ) in m/s.

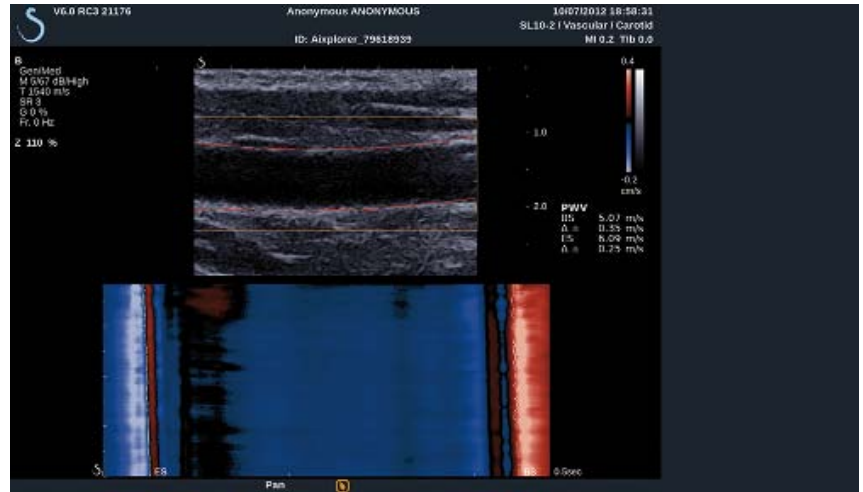



## B-Mode Scanning Tips



### B-MODE SCANNING

Use appropriate Preset for each organ being scanned

Set depth to achieve desired field of view

Place focal zone at the depth of the area of interest or slightly below

Press AutoTGC to obtain a homogeneous image

Adjust overall gain to obtain the appropriate brightness

Adjust TissueTuner™ to achieve the best resolution

Increase focal zone region for a larger focal area and increased resolution

Use Harmonic Imaging to clear fluid-filled structures

Use Res setting of Res/Fr. rate control for increased resolution

Use Fr. Rate setting of Res/Fr. rate control for increased temporal resolution



# ShearWave™ Elastography

The ShearWave™ Elastography (SWE™) mode displays information about tissue elasticity in the form of an easy to interpret color-coded image.

The elasticity information is also quantitative. Local estimation of the tissue stiffness is displayed per pixel, and can be expressed in kPa or in m/ s over a wide range of values.

## Accessing ShearWave™ Elastography

Press **SWE™** on the control panel from any other mode.



## About the SWE™ Main Display

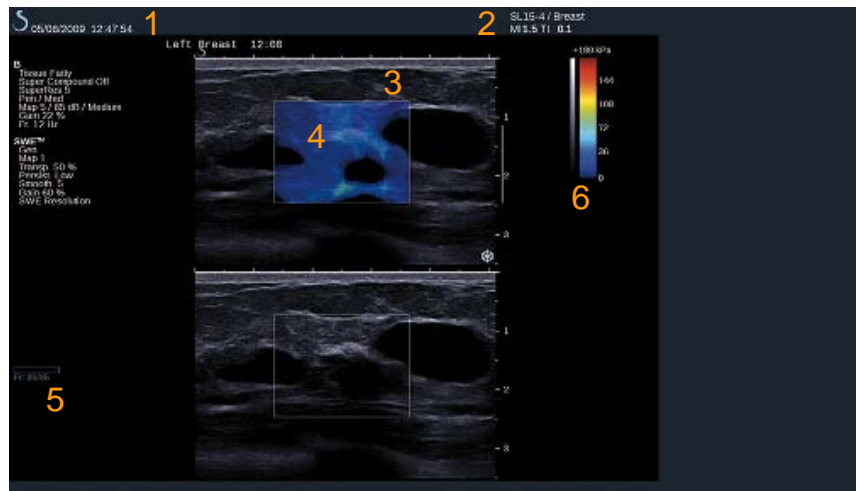

1. Exam and patient information
3. Ultrasound image

2. Transducer/Preset/ MI/TI
4. Elasticity map

5. Clip buffer

6. Grayscale and elasticity bars

## About SWE™ touch screen

When in SWE™, the touch screen displays various image settings which help you to optimize your elasticity image.

There are two pages of SWE™ parameters. These settings are controlled by touching the control on the touch screen or turning the rotary knob directly below it.



You can navigate through the pages by touching **Other Settings**.

## Description of SWE™ Parameters

### SWE™ OPTIMIZATION



**SWE Opt** allows you to optimize the elastography resolution and penetration according to the area you are scanning.

**SWE Opt** is available in live imaging only.

Rotate the knob located under **SWE Opt**:

- clockwise to go to next value
- counterclockwise to go to previous value

There are 3 settings to choose from:

- **Resolution**

Use this setting when imaging small shallow areas of interest.

This setting will also help to clear any erroneous elastography signal out of areas which are suspected to be comprised of fluid.

- **Standard**

This setting is balanced between resolution and penetration.

Use this setting as the default starting point for evaluation the stiffness of a object of interest

- **Penetration**

Use this setting when imaging deeper or larger areas (anechoic or hypoechoic) which may show posterior dropout in the echo image.

These areas are suspected to be stiff and require a penetration mode optimized for high velocity shear waves.

## DISPLAY UNIT



This control allows you to change the color bar scale for SWE™ from kPa to m/s.

**Display Unit** is available in live mode and on a frozen image.

Touch **Display Unit** to change its value.

## ELASTICITY RANGE



The **Elasticity Range** in SWE™ mode is similar to the dynamic range in B-mode. It changes the maximum elastic value displayed.

It is used to compress the colored image for better visualization of tissues which have a variety of stiffnesses.

It does not affect the actual values of elasticity, as long as they are within the elasticity range.

**Elasticity Range** is available in live imaging or on a frozen image.

Rotate the knob located under **Elasticity Range**:

- clockwise to increase the elasticity range
- counterclockwise to decrease the elasticity range

**Elasticity Range** is displayed in kPa, the values depend on the selected application.

Stiff tissue should appear yellow, orange or red.

Increase the **Elasticity Range** if you see predominantly dark red in the color box.

## VELOCITY RANGE

The **Velocity Range** works in the same manner as the **Elasticity Range**.

**Velocity Range** appears and replaces **Elasticity Range** when the **Display Unit** is set to **m/s**.

It changes the maximum velocity value displayed.

It is used to compress the colored image for better visualization of tissues which have a variety of stiffnesses.

It does not affect the actual values of velocity, as long as they are within the velocity range.

## DISPLAY FORMAT

This control changes the format in which B-mode and SWE™ images are presented on the main display.

**Display Format** is available in live imaging and on a frozen image. Press **Display format** until you select the desired format. The top/bottom format is the default setting.

Three formats are available:

- top/bottom
- side by side
- single



## OPACITY

**Opacity** allows you to change the transparency of the elasticity map over the B-mode image.

**Opacity** is available in live imaging and on a frozen image.

Rotate the knob located under **Opacity**:

- clockwise to increase the prominence of the color image over the B-mode image
- counterclockwise to decrease the prominence of the color image over the B-mode image

**Opacity** ranges from 0 to 100%.

The default setting is 50%.



## HD/FR. RATE



**HD/Fr. rate** allows you to adjust frame rate and line density to achieve increased spatial or temporal resolution.

There are three options to choose from:

- HD (High Definition): left LED
- Balanced: middle LED
- Fr. Rate (Frame Rate): right LED

Touch **HD/Fr. Rate** to change the value.

## ELASTICITY MAP



**Elasticity Map** determines how elasticity values are displayed in terms of color graduations.

**Elasticity Map** is available in live imaging and on a frozen image.

Rotate the knob located under **Elasticity Map**:

- clockwise to go to the next map
- counterclockwise to go to the previous map

## ACOUSTIC POWER



**Acoustic Power** indicates the output acoustic power.

**Acoustic Power** is available only in live mode.

Rotate the knob located under **Acoustic Power**:

- clockwise to increase acoustic power
- counterclockwise to decrease acoustic power

**Acoustic Power** values vary from 0dB to -30dB.



## SMOOTHING

**Smoothing** is a spatial filter used to smooth the elasticity map in order to provide a more homogeneous appearance.

**Smoothing** is available only in live imaging.

Rotate the knob located under **Smoothing**:

- clockwise to increase smoothing
- counterclockwise to decrease smoothing



## PERSISTENCE

This frame averaging technique reduces noise on the image.

**Persistence** is available in only in live imaging.

Rotate the rotary knob located under **Persistence**:

- clockwise to increase persistence
- counterclockwise to decrease persistence



## Q-BOX™

Refer to [the section called “Q-Box™” \[268\]](#).

## Q-BOX™ RATIO

Refer to [the section called “Q-Box™ Ratio” \[268\]](#).

# SWE™ Scanning TIPS



## SWE™ SCANNING

Remember the 3 S's:

Scan **Softly**, **Smoothly** and **Slowly**

Scan **Softly**: no manual compression is needed (with the exception of intercostal liver scanning), just a light touch and plenty of gel between skin and transducer

Scan **Smoothly**: transducer automatically induces vibrations in tissues so no need to shake or push on the transducer

Scan **Slowly**: Adapt your speed of scanning to the frame rate. Once you are imaging the area of interest, avoid any movements and wait for image stabilization

Always start with the default setting of Standard for SWE Opt, and then go to Resolution or Penetration to fine tune the image.

Controls that can be used in live or frozen mode such as Elasticity Range, display format, etc. should be done after freezing to make it easier for user since it is imperative to hold a steady hand during elastography



# Color Mode Imaging

Color imaging modes use Doppler principles to generate a color image of the mean flow velocity or flow power.

On the Aixplorer® ultrasound system, three color modes are available: Color Flow Imaging (CFI), Color Power Imaging (CPI), and Directional Color Power Imaging (DCPI).

## The Various Color Modes

Color imaging modes use Doppler principles to generate a color image of the mean flow velocity or flow power.

On the Aixplorer® ultrasound system, three color modes are available: Color Flow Imaging (CFI), Color Power Imaging (CPI), and Directional Color Power Imaging (DCPI).

### COLOR FLOW IMAGING (CFI)

Color Flow Imaging is a Doppler mode intended to add color-coded quantitative information concerning the relative velocity and direction of fluid motion within the B-mode image.

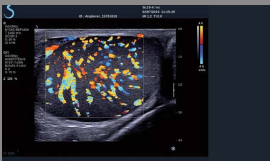

### COLOR POWER IMAGING (CPI)

Color Power Imaging is a color flow mapping technique used to map the strength of the Doppler signal coming from the flow rather than the frequency shift of the signal. Using this technique, the ultrasound system displays the magnitude of the flow based on the number of reflectors that are moving, regardless of their velocity. CPI does not map flow velocity.

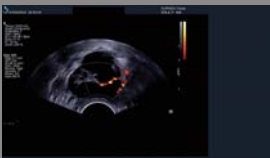

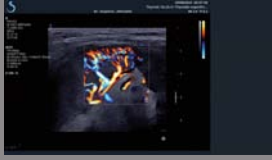

## DIRECTIONAL COLOR POWER IMAGING (DCPI)

Directional Color Power Imaging (DCPI) is a new flow imaging mode, which complements the two existing flow imaging modes, namely Color Flow Imaging (CFI) and Color Power Imaging (CPI). dCPI displays the mean Doppler frequency of each pixel inside the Color box, including the direction of flow relative to the transducer.

The color maps used in dCPI are separated into parts which typically contain red and blue hues, respectively, with positive Doppler frequencies (flow towards the transducer) displayed using the top part of the dCPI color map, and negative Doppler frequencies (flow away from the transducer) displayed using the bottom part of the dCPI color map.

dCPI is useful in indicating the flow direction within the vessels of interest, as well as identifying areas of high flow velocities (aliasing), flow reversals, etc.

## Accessing Color Modes

Press **COL** on the control panel from any other modes.



## About Color Modes Main Display



1. Focal Zone
2. Grayscale
3. Color bar

4. Color box

## About Color Modes Touch Screen

When in color modes, the touch screen displays various image settings which help you to optimize the color image.

There are two pages of color parameters. These settings are controlled by touching the control on the touch screen or turning the rotary knob directly below it.



You can navigate through the pages by touching **Other Settings**.

# Description of Color Imaging Parameters

## COLOR MODE



**Color Mode** allows you to switch between CFI, dCPI and CPI.

**Color Mode** is available only in live imaging.

Touch **Color Mode** to select the desired mode.

## DUAL

See [the section called “Dual” \[159\]](#).

## RES/PEN



**Res/Pen** allows you to change the center frequency to reach increased resolution or increased penetration.

**Res/Pen** is available only in live imaging.

Press **Res/Pen** to change the value.

The orange LED indicates which value is active:

- Left LED: Res (resolution)
- Middle LED: Gen (general)
- Right LED: Pen (penetration)



## HD/FR. RATE

**HD/Fr. rate** allows you to adjust frame rate and line density to achieve increased spatial or temporal resolution.

There are three options to choose from:

- HD (High Definition): left LED
- Medium: middle LED
- Fr. Rate (Frame Rate): right LED

Touch **HD/Fr. Rate** to change its value.



## INVERT

**Invert** lets you view blood flow from an inverse perspective, e.g. red away (negative velocities) and blue toward (positive velocities) the transducer.

**Invert** is available in live imaging and on a frozen image.

Invert is available only in CFI mode.

Touch **Invert** to activate and deactivate it.



## SIDE BY SIDE

**Side by Side** allows you to split the screen in two live parts:

- the left side displays the B-mode only, for reference
- the right side displays the B-mode and the color image



## HIDE COLOR



**Hide Color** hides the color information over the B-mode image. **Hide Color** is available in live imaging and on a frozen image. Touch **Hide Color** to activate and deactivate it.

## WALL FILTER



This parameter filters out low velocity signals. It helps reduce motion artifacts caused from breathing and other patient motion. **Wall Filter** is available only in live imaging. Touch **Wall Filter** until you select the desired value.

## VELOCITY OPTIMIZATION



**Velocity Opt.** allows you to quickly optimize multiple parameters with one control to achieve a desired flow optimization. **Velocity Opt.** changes the following parameters:

- scale
- wall filter
- resolution/frame rate
- persistence

**Velocity Opt.** is available only in live imaging. Touch **Velocity Opt.** until you select the desired value.

## SCALE

**Scale** allows you to adjust the maximum displayed velocity.

**Scale** is available only in live imaging.

Rotate the knob located under **Scale**:

- clockwise to increase the scale
- counterclockwise to decrease the scale



## BASELINE

**Baseline** is a horizontal graphical line on the Color Map that represents the level of zero velocity.

The baseline position contributes in defining the maximum positive and negative velocities.

By changing the baseline position, you increase the maximum positive velocity and decrease the maximum negative velocity, or vice versa.

**Baseline** is available only in live imaging and on a frozen image.

Rotate the knob located under **Baseline**:

- clockwise to increase the maximum positive velocities
- counterclockwise to increase the maximum negative velocities

Note: The **Baseline** control is available only in CFI mode. In CPI, it is replaced by **Dynamic Range**.

**Dynamic Range** allows you to change the range over which the amplitude of returning ultrasound signals are displayed. It behaves in the same manner as **Baseline**.



## QUICK STEER

**Quick Steer** allows you to quickly steer the insonifying beam.

Press **Quick Steer** to change its value.

Use the **Steering** knob for finer settings.



## STEERING



To maximize the sensitivity and accuracy of color Doppler modes, it is usually recommended that clinical Doppler examinations be conducted with a Doppler angle equal to or less than 60 degrees between the ultrasound beam and the vessel direction.

**Steering** is available only in live imaging.

Rotate the knob located under **Steering** to steer the color box.

## ACOUSTIC POWER



**Acoustic Power** indicates the output acoustic power.

**Acoustic Power** is available only in live mode.

Rotate the knob located under **Acoustic Power**:

- clockwise to increase acoustic power
- counterclockwise to decrease acoustic power

**Acoustic Power** values vary from 0dB (maximum power) to -20dB (minimum power).

## SMOOTHING



**Smoothing** is a spatial filter used to smooth the color image in order to provide a more homogeneous appearance.

**Smoothing** is available only in live imaging.

Rotate the knob located under **Smoothing**:

- clockwise to increase smoothing
- counterclockwise to decrease smoothing

## PERSISTENCE



This frame averaging technique reduces noise on the image.

**Persistence** is available in live imaging and on a frozen image (to view clips).

Rotate the rotary knob located under **Persistence**:

- clockwise to increase persistence
- counterclockwise to decrease persistence

## COLOR PRIORITY



**Color Priority** allows you to select a level beyond which color data are not displayed over the gray map.

**Color Priority** is available in live imaging and on a frozen image.

Rotate the knob located under **Color Priority**:

- clockwise to increase the color priority
- counterclockwise to decrease color priority

The range and default value depend on the application.

## COLOR MAP



**Color Map** determines how flow values are displayed in terms of color graduations.

**Color Map** is available in live imaging and on a frozen image.

Rotate the knob located under **Color Map**:

- clockwise to go to next map
- counterclockwise to go to previous map

## BLENDING



This button controls the level of transparency of the color image that is superimposed on the B-mode image.

When **Blending** is on, the color image is smoothly overlaid on the grayscale image.

When **Blending** is Off, the transition between B-mode and color is sharper.

**Blending** is available in live imaging and on a frozen image.

Press **Blending** to turn it On or Off.

## FLASH SUPPRESSION



**Flash Suppression** utilizes an adaptive wall filtering scheme in order to suppress the flash artifacts due to tissue motion.

When **Flash Suppression** is On, the frame rate is reduced.

**Flash Suppression** is available only in live imaging.

Press **Flash Suppression** to turn it On or Off.

## ULTRAFAST™ DOPPLER ACQUISITION



**UltraFast™ Doppler Acquisition** launches a 2-second prospective capture of CFI, CPI or dCPI at high frame rates.

**UltraFast™ Doppler Acquisition** is only available with the SL10-2 and SC6-1 probes.

Once you have chosen the imaging plane, press **UltraFast™ Doppler Acquisition** to start the acquisition.

Do not move the probe as long as the message “acquiring...” is displayed on the screen.

When the acquisition is complete, you have access to the following controls:

## Color Gain



Rotate the **COL** button in order to change the gain in review:

- clockwise to increase the gain
- counterclockwise to decrease the gain

## Display Format



**Display Format** allows you to change the view mode as follows:

- **Full screen** displays the image only
- **Quad** divides the screen into 4 parts: Clip, Mean Velocities, Peak Systolic frame and Max Velocities

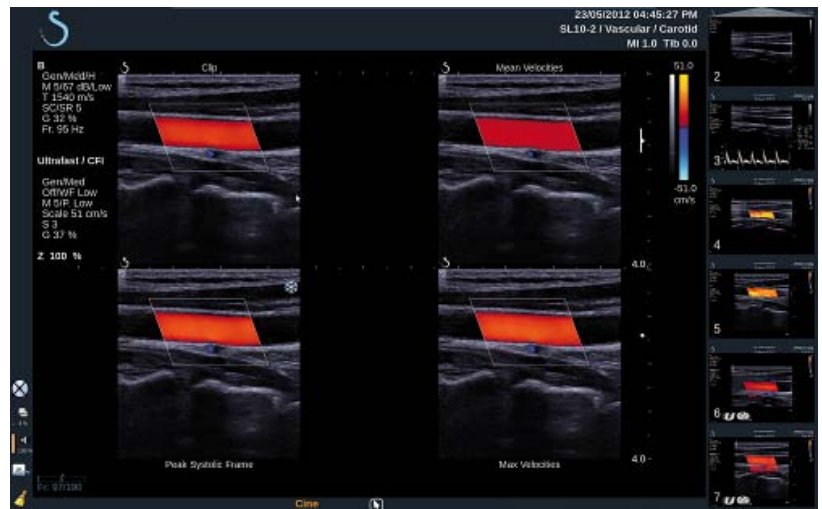

- **Spectrogram** displays the image on the top and the spectrograms underneath.

Press **Display Format** until you select the desired format.



The button next to **Display Format** allows you to control the image: **Clip** allows you to scroll the UltraFast™ Doppler clip

- **PS** displays the image of the UltraFast™ Doppler clip that contains the peak systolic frame
- **Max** displays a calculated image corresponding to the maximum velocity of each pixel within the UltraFast™ Doppler clip
- **Mean** displays a calculated image corresponding to the mean velocity of each pixel within the UltraFast™ Doppler clip

Press the desired part of the button to change the view mode.

## Display Peak Systolic Frame

This control automatically locates and displays the peak frame in the UltraFast™ Doppler CFI clip buffer.



## Color Map

See [the section called “Color Map” \[200\]](#).

## Blending

See [the section called “Blending” \[201\]](#).

## Hide Color

See [the section called “Hide Color” \[197\]](#).

## Persistence

See [the section called “Persistence” \[200\]](#).

## Color Priority

See [the section called “Color Priority” \[200\]](#).

## Add Spectrogram



In UltraFast™ Doppler mode, you have the capability to add up to 3 sample volumes on the reviewed image to compute simultaneous spectrograms.

1. Press **Add Spectrogram** to add a spectrogram
2. Use the **TouchRing™** to resize the sample volume
3. Move the **Trackball** to locate the sample volume on the image and update the spectrogram

The active spectrogram appears surrounded with an orange rectangle. Press **Select** on the Control Panel to change the active spectrogram. You may add measurements on the active spectrogram. See [the section called “Performing Measurements” \[254\]](#).

Once a spectrogram has been added, you have access to a variety of PW parameters and tools.

## Delete Spectrogram



This control deletes the active spectrogram and corresponding sample volume from the image.



## Wall Filter

See [the section called “Wall Filter” \[215\]](#). This control is available in review in UltraFast™ Doppler mode.

## Sweep Speed

See [the section called “Sweep Speed” \[216\]](#).

You may change the following parameters for the individual active spectrogram:

## Baseline

See [the section called “Baseline” \[215\]](#).

## Scale

See [the section called “Scale” \[215\]](#).

## Coarse Angle

See [the section called “PW Coarse Angle” \[212\]](#).

## Fine Angle Correct

See [the section called “Fine Angle Correct” \[213\]](#).

## PW Map

See [the section called “PW Map” \[214\]](#).

## Invert

See [the section called “Invert” \[214\]](#).

## PW gain

Rotate the **PW** button in order to change the gain in review:

- clockwise to increase the gain
- counterclockwise to decrease the gain

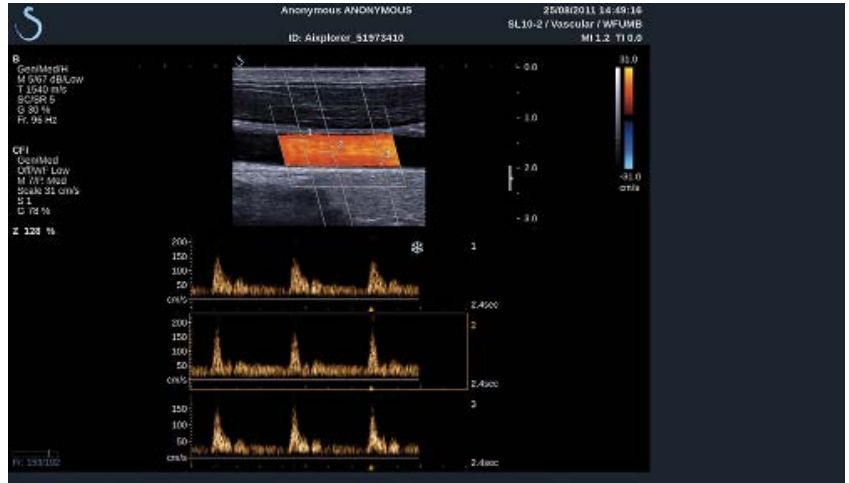

## COLOR Scanning TIPS



### COLOR SCANNING

Scan to obtain best angle to maximize flow sensitivity.

Use the TouchRing™ to change size of color box if needed. A larger box will cause a decrease in temporal resolution (frame rate).

Increase Color Gain until you see noise and then reduce the gain just to eliminate noise. This will ensure that you have the best color flow sensitivity possible.

If scanning smaller vessels (i.e. breast, thyroid), center steer is typically the best choice. In larger vessels (i.e. carotid artery, axillary artery) steer color box to obtain the best (least) angle to flow. You will see a change in sensitivity when you choose the appropriate steering angle.

Select the appropriate Velocity Optimization level according to the type of vessel you are interrogating.

Low is typically used for smaller vessels with lower velocities and venous flows.

High is used for larger vessels with higher velocities and for arteries.

To increase flow sensitivity, you can lower the Scale or lower the Wall Filter.

To eliminate aliasing (CFI only), increase the Scale.

Do not move the probe while acquiring an UltraFast™ Doppler CFI clip

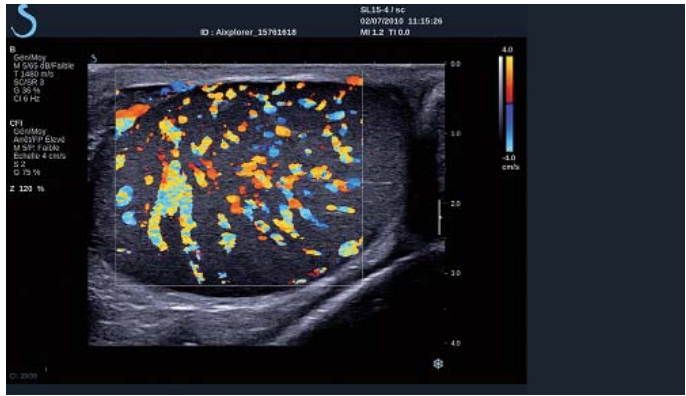

## Pulsed Wave Doppler Mode

Pulsed Wave Doppler (PW) is a Doppler mode that measures velocity of blood flow within a small region called the Doppler sample volume.

This information is presented as a sweeping display of velocity (or Doppler frequency) over time. This display is often called a spectral Doppler trace, or Doppler trace. The information may also be heard as a stereo audio output.

In addition to the Doppler velocity display, an image (grayscale only or grayscale and color) is also presented to guide you for proper positioning of the Doppler sample volume.

## Accessing PW

Press **PW** on the control panel from any other modes.



## About PW Main Display

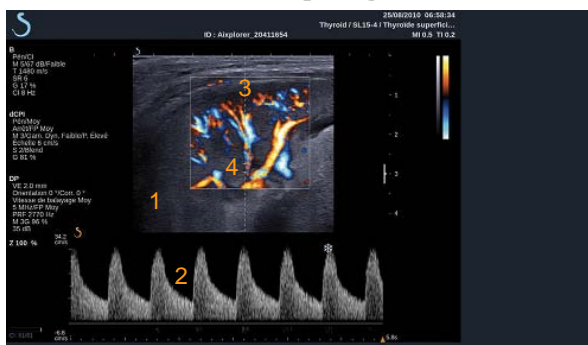

1. Grayscale image
2. Spectral display
3. Doppler line
4. Sample volume

## About PW Touch Screen

When in PW, the touch screen displays various image settings which help you to optimize your PW image and trace.

There are two pages of PW parameters. These settings are controlled by touching the control on the touch screen or turning the rotary knob directly below it.



You can navigate through the pages by touching **Other Settings**.

## Setting Up PW

### DOPPLER LINE



Move the **trackball** left and right to move the Doppler line in the 2D image.

### SAMPLE VOLUME POSITION

Move the **trackball** up and down to move the sample volume on the Doppler line.

### SAMPLE VOLUME SIZE



Slide your finger on the **TouchRing™** to change the size of the sample volume.

# Description of PW Imaging Parameters

## QUICK STEER



**Quick Steer** allows you to quickly steer the insonifying beam. Press **Quick Steer** to change its value. Use the **Steering** knob for finer settings.

## STEERING



The insonifying beam can be steered in a direction as close as possible to the expected direction of motion, within limitations imposed by the transducer and the image plane geometry.

**Steering** is available only in live imaging. Rotate the knob located under **Steering** to steer the Doppler line.

## PW COARSE ANGLE



**PW Coarse Angle** is available in live imaging and on a frozen image.

PW Coarse Angle is available in live mode only.

Touch **PW Coarse Angle** until you select the desired value.



## FINE ANGLE CORRECT



**Fine Angle Correct** is available in live imaging and on a frozen image.

Rotate the knob located under **Fine Angle Correct**.

## ACOUSTIC POWER



**Acoustic Power** indicates the output acoustic power.

**Acoustic Power** is available only in live mode.

Rotate the knob located under **Acoustic Power**:

- clockwise to increase acoustic power
- counterclockwise to decrease acoustic power

**Acoustic Power** values vary from 0dB (maximum power) to -20dB (minimum power).

## DYNAMIC RANGE



You can optimize the PW dynamic range independently from the B-mode dynamic range.

Rotate the rotary knob located under **Dynamic Range**:

- clockwise to increase the dynamic range
- counterclockwise to decrease the dynamic range

## DISPLAY FORMAT



**Display Format** is available in live imaging and on a frozen image.

Press **Display Format** to change its value.

5 display formats are available:

- 2D only
- $\frac{1}{2}$  B-mode and  $\frac{1}{2}$  spectral side by side display
- Spectral display only
- $\frac{2}{3}$  B-mode and  $\frac{1}{3}$  spectral display
- $\frac{1}{3}$  B-mode and  $\frac{2}{3}$  spectral display

## PW MAP



**PW Map** is available in live imaging and on a frozen image.

Rotate the knob located under **PW Map**:

- clockwise to go to previous map
- counterclockwise to go to next map

## INVERT



**Invert** vertically flips the spectral display without affecting the baseline position.

Typically, positive velocities (velocities toward the transducer) are shown above the baseline while negative velocities (velocities away from the transducer) are shown below the baseline.

**Invert** flips the location of positive and negative velocities relative to the baseline.

**Invert** is available in live imaging and on a frozen image.

Touch **Invert** to activate and deactivate it.

## WALL FILTER



This parameter filters out low velocity signals.

It helps to decrease motion artifacts caused by patient or transducer motion.

**Wall Filter** is available only in live imaging.

Touch **Wall Filter** until you select the desired value.

## SCALE



**Scale** allows you to modify the maximum velocities displayed on the Doppler spectrum.

**Scale** is available only in live imaging.

Rotate the knob located under **Scale**:

- clockwise to increase the scale
- counterclockwise to decrease the scale

## BASELINE



**Baseline** is a horizontal graphical line that represents the level of zero velocity.

The baseline position contributes in defining the maximum positive and negative velocities.

By changing the baseline position, you increase the maximum positive velocity and decrease the maximum negative velocity, or vice versa.

**Baseline** is available only in live imaging and on a frozen image.

Rotate the knob located under **Baseline**:

- clockwise to increase the maximum positive velocities
- counterclockwise to increase the maximum negative velocities

## SWEEP SPEED

**Sweep Speed** allows you to change the speed with which the spectral columns are updated on the display.

**Sweep Speed** is available in live imaging and on a frozen image.

Touch **Sweep Speed** until you reach the desired value.



## SIMULTANEOUS DUPLEX AND TRIPLE MODES

**Simultaneous** allows real-time evaluation of vascularity when respiration or motion make stand alone PW evaluation more difficult.

**Simultaneous** is available only in live imaging.

Touch **Simultaneous** to turn it On or Off.

In B-mode, **Simultaneous** displays and updates the PW spectral trace and the B-mode image.

In Color, **Simultaneous** displays and updates the PW spectral trace and the Color image.



## HIGH PRF

**High PRF** allows you to measure flows of higher velocities than those that can be measured with the maximum conventional available PRF, by increasing the PRF above the Nyquist limit and avoiding aliasing.

How it works:

**High PRF** extends the PW Doppler velocity scale beyond the maximum velocity limit that can be measured for a given sample volume in a nonambiguous manner. Beyond this limit, the Pulse Repetition Frequency (PRF) of the transmitted PW Doppler pulses corresponds to a Pulse Repetition Interval (PRI) which is shorter than the roundtrip propagation time from the transducer to the current sample volume depth,



resulting in range ambiguity (the analyzed Doppler signals emanate not only from the primary sample volume of interest but also from one or two secondary sample volumes along the Doppler beam).

How to use it:

Touch **High PRF** to turn it on.

The maximum scale available is increased as a function of depth.

**High PRF** is available for all presets on all probes in live PW.



## SCANNING RECOMMENDATIONS

- Position the primary SV in the area of interest, as you would in conventional PW Doppler.
- Avoid, as much as possible, placing secondary SV's in areas dominated by noise artifacts, shadowing, or areas of flow.
- These tips may assist you in positioning secondary High PRF SV's to optimize the signal and avoid interference with the primary SV:
  - Vary the velocity range to change the secondary sample volume position.
  - Vary the depth of the image to change the secondary sample volume position.
  - Reduce the velocity range to remove the secondary sample volume.
  - Reduce gain.
  - Vary 2D image orientation.
  - Change the acoustic window.

## PW AUTOTRACE

This control allows you to perform automatic PW measurements.

You may customize which measurements are displayed when performing a PW Autotrace in the System Configuration.

**PW Autotrace** is available in live imaging and on a frozen image.



Press **PW Autotrace** to display the envelope of the peak velocity of the flow as a function of time.

When the **PW Autotrace** is activated, you have access to the following settings:

## Mean Trace

Press **Mean Trace** to display the mean flow velocity as a function of time.

## Velocity Points

Press **Velocity Points** to display the PSV and EDV on the spectrum.



## Trace Detection

**Trace Detection** allows you to switch between various displays:

- the positive peak velocity
- the negative peak velocity
- both positive and negative peak velocity

Press **Trace Detection** to change its value.



## Sensitivity

This control defines the detection threshold for the PW Autotrace.  
Press **Sensitivity** to change its value.



## Select Cycles

This control allows you to change the cardiac cycles on which the values calculated when the PW Autotrace is launched are averaged.

Rotate the knob located under **Select Cycles**:

- clockwise to select next cycle(s)
- counterclockwise to select previous cycle(s)



## Nb Cycles

By default, the calculated values when the PW Autotrace is launched are averaged on 3 cardiac cycles from the end of the PW spectrum.

Press **Nb Cycles** to change its value.



## PW Scanning TIPS



### PW SCANNING

As in color Doppler, optimize the scan plane for the best angle to flow.

Activate the PW cursor by pressing PW. Optimize the steering angle and sample volume size (trackball ring) before initiating the PW spectral trace. If Color is activated before pressing PW, then the cursor will be at the same steer angle as the color box.

Optimize Doppler gain. Decrease gain to eliminate background noise.

Increase scale or shift baseline to eliminate aliasing.

You can always shift baseline, change display format, PW map and sweep speed after freezing.

Use Simultaneous mode when vessels are difficult to follow due to respiration, motion or small vessel size.

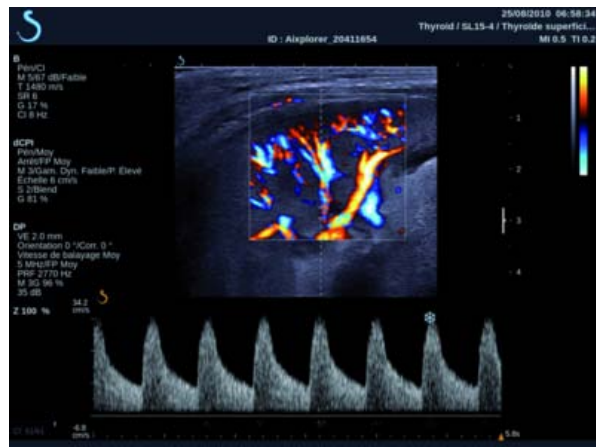



# 3D Imaging

## Accessing 3D Imaging

The 3D package is available with the SLV16-5 probe for the Breast and General applications.

The 3D mode is available with B-mode and SWE mode.

Before starting a 3D acquisition:

1. Make sure the SLV16-5 is plugged in
2. Press **Probe** on the control panel
3. Select an **application** tab on the touch screen
4. Select the desired **Preset**
5. Scan to locate the region of interest and optimize the image

## Acquisition

1. Press **Volume Size** until you select the size of the volume you want to acquire:
  - M
  - L
  - XL
2. Press the **3D Acquisition** button to start the 3D acquisition



During the acquisition, a progress bar is displayed on the screen.

To cancel the 3D acquisition in progress, press **3D Acquisition** again.

# Multi-Planar Reconstruction (MPR)

## MPR ACTIVE VIEW

Press **A** (Axial), **C** (Coronal), **T** (Transverse), or **3D** to select the active view.

## MPR DISPLAY

When the 3D acquisition is complete, the system displays the default Multi Plane view.

Rotate the knob located under **View Mode** to change the Multi Plane view mode.

The active view will define the reference view to be displayed in the different view modes.

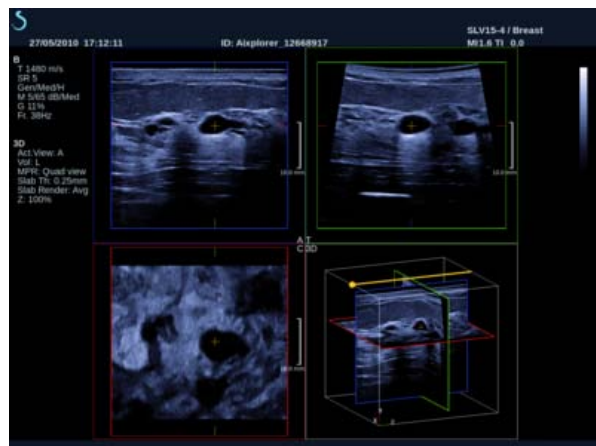

## MPR NAVIGATION



When the **Pointer** is ON:

1. Press **Navigation** on the touch screen until Translate is selected
2. Select the navigation view with the **Select** button
3. Use the **TouchRing™** and the **Trackball** to navigate in the selected view



When the **Pointer** is OFF:

1. Press **Navigation** on the touch screen until Translate is selected
2. Use the **TouchRing™** and the **Trackball** to navigate in the selected view

## ROTATION



When the **Pointer** is ON:

1. Press **Navigation** on the touch screen until Rotation is selected
2. Move the **Pointer** on the view you want to rotate
3. Use the **TouchRing™** to rotate the selected view
4. Press **Select** to center the planes that are perpendicular to the selected view

When the **Pointer** is OFF:

1. Press **Navigation** on the touch screen until Rotation is selected
2. Use the **TouchRing™** and the **Trackball** to rotate the selected view

## OTHER CONTROLS

### Slab thickness

Rotate the knob located under **Slab thickness** to change the value



### Slab rendering

Rotate the knob located under **Slab Render** to change the value.

- Use **Min** to reinforce hypoechoic structures
- Use **Max** to reinforce hyperechoic structures
- Use **Avg** or **Median** to enhance contrast/resolution trade-off



### Zoom

Rotate **Zoom** to zoom on the intersection of A, T and C planes.



## Multi Slice (MS)

Press **Multi Slice** on the touch screen to access Multi Slice mode



## ACTIVE VIEW

Press **A**, **C** or **T** to select the active view.



## DISPLAY

Press **Slice Number** to change the number of slices displayed on the screen.

## NAVIGATION

Use the **TouchRing™** to translate the middle plane of the MultiSlice display.



## OTHER CONTROLS

### Slice distance

Rotate the knob located under **Slice distance** to change the value.

### Slab thickness

Rotate the knob located under **Slab thickness** to change the value.

### Slab rendering

Rotate the knob located under **Slab rendering** to change the value.

## 3D History Loop

You can view a clip of the 2D images acquired during the 3D acquisition.

Deactivate **Multiplane** and **Multislice** on the touch screen. The system is in 3D history loop mode.

Use the **trackball** to scroll the 3D history loop.



## 3D and SWE™

### SWE 3D FILTER

**3D Filter** is a smoothing spatial filter that allows you to smooth the elasticity map.

Rotate the knob located under **3D Filter** to increase or decrease smoothing.

## 3D Measurements

In addition to the 2d measurement tools, Aixplorer® is providing various measurement features for the assessment of volume both in Multiplanar and MultiSlice displays:

- 3D volume calculated from an ellipse and a distance (MPR)
- 3D volume calculated from 3 distances (MPR)
- 3D volume calculated from a collection of traces distributed in a volume (MS).

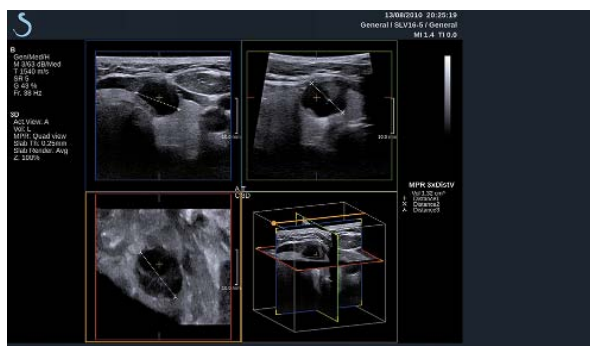

### BASIC MEASUREMENTS

Refer to 2D [the section called “Basic Measurements”\[254\]](#) for a step by step description of distance, ellipse, trace, Q-Box™ and Q-Box Ratio™ measurements.

### LABELED MEASUREMENTS

Refer to 2D [the section called “Labeled Measurements” \[272\]](#).

### 3D-SPECIFIC MEASUREMENTS

#### Ellipse Distance Volume

The Ellipse distance 3D volume measurement tool is available in MPR display only.



1. Press **Meas. Tools** on the touch screen
2. Press **Volume (Ellipse + Distance)**
3. Use your preferred method to draw an ellipse on the plane of interest (see 2D [the section called “Basic Measurements” \[254\]](#))  
Once the ellipse is drawn, the system displays the first caliper of a distance measurement.
4. Choose an orthogonal plane to draw the distance  
Once the distance is drawn, the system displays the values of the volume in the measurement result area.

### 3-Distance Volume

The 3-distance 3D volume measurement tool is available in MPR display only.

1. Press **Meas. Tools** on the touch screen
2. Press **Volume (3 Distance)**
3. Use your preferred method to draw 2 distances (see 2D [the section called “Basic Measurements” \[254\]](#)) on the plane of interest

Once the first distance is drawn, the system displays the first caliper of the second distance measurement.

1. Once the second distance is drawn, choose an orthogonal plane to draw the last distance

Once the last distance is drawn, the system displays the values of the volume in the measurement result area.

### Trace Collection Volume

The trace collection 3D volume measurement tool is available in MS display only.

1. Press **Meas. Tools** on the touch screen
2. Press **Volume (Trace Method)**
3. Use your preferred method to draw a first trace on a given slice (see 2D [the section called “Basic Measurements” \[254\]](#))



Once the first trace is drawn, the system displays the first caliper of the next adjacent slice.

1. Draw as many trace measurements as needed (a minimum of 2 is required to calculate a volume)
2. Press **End** to finalize the measurement

The system displays the values of the volume in the measurement result area.

## **3D On-cart Review Package**

The 3D on-cart review package allows you to append a closed exam and save a secondary capture with new information from acquired 3D volumes coming from the former exam.

# Contrast Enhanced Ultrasound Imaging (CEUS)

Contrast Enhanced Ultrasound Imaging (CEUS) is a mode of imaging which allows you to assess micro and macro-vascular perfusion information in an ultrasound image.

CEUS requires that the ultrasound imaging be performed in conjunction with the injection of a microbubble based contrast agent.

The microbubbles appear as intravascular tracers in the ultrasound image, allowing the differentiation of structures based on their vascularity.

Note: SuperSonic Imagine does not sell contrast agent products.



## **WARNING**

At the time of publication, the United States Food and Drug Administration does not allow the use of contrast agents in the United States without the approval of an institutional Review Board (IRB).

Carefully follow manufacturer's instructions for use, including indications and contra indications, when administering ultrasound contrast agents.

## Accessing CEUS mode



Press **CEUS** on the control panel from any other mode.  
This will engage the CEUS and B-mode side-by-side display.

## About CEUS Mode Main Display

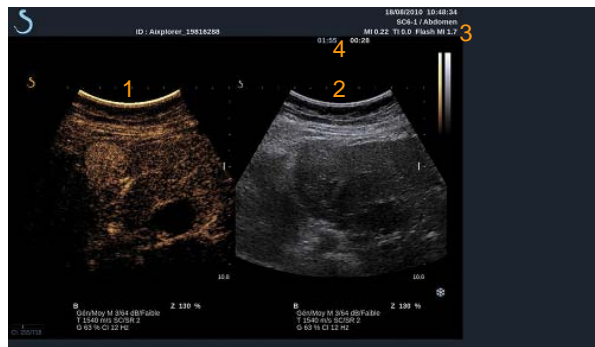

1. contrast image
2. grayscale image
3. MI and TI information
4. Timers

The CEUS display on the left is the default image, and the CEUS controls are active by default.

Some panel controls such as the **Gain** knob and **AutoTGC** are shared between CEUS and B-mode. The currently selected mode will determine which image the control will act upon.

## About CEUS mode touch screen

When in CEUS mode, the touch screen displays various image controls which help you to optimize the CEUS mode image.

There are two pages of CEUS mode parameters, and two pages of Low-MI B-mode parameters. These settings are controlled by touching the control on the touch screen, or by turning the rotary knob directly below the touch screen.



CEUS touch screen parameters



### Low-MI B-mode touch screen parameters

You can navigate through the pages by touching **Other Settings**.

## Description of CEUS Parameters

### CONTRAST AGENT



**Contrast Agent** control allows you to optimize several CEUS imaging parameters to better visualize specific commercially available microbubble contrast agents.

Press **Contrast Agent** to choose a commercially available microbubble contrast agent.

### CEUS RES/PEN



**CEUS Res/Pen** acts on the CEUS image and allows you to change center frequency to obtain increased contrast resolution or increased penetration.

**CEUS Res/Pen** is available only in live imaging.

Press **CEUS Res/Pen** to change value.

The orange LED indicates which one is the active value:

- Left LED: Res (resolution)
- Middle LED: Gen (general)
- Right LED: Pen (penetration)

### CEUS HD/FR. RATE



**CEUS HD/Fr. Rate** allows you to adjust the CEUS image frame rate and line density to achieve increased spatial or temporal resolution.

Touch **CEUS HD/Fr. Rate** to change value.

There are three options to choose from:

- HD (High Definition): left LED
- Balanced: middle LED
- Fr. Rate (Frame Rate): right LED





## CEUS GAIN

CEUS Gain allows the user to adjust the overall gain of the CEUS image. The CEUS gain control is the same knob as the B-mode gain knob while in CEUS mode.

To adjust image Gain in CEUS mode:

Rotate the **B** mode knob on the control panel when the mode indicator is labeled CEUS.



## TIMER

**Timer** allows you to start a clock which is used to record the time of microbubble contrast delivery.

**Timer** is available in live imaging only.

Press the **Timer** button to activate. The LED indicator will light.

Press the **Timer** button again to pause the clock.



## FLASH

**Flash** will send a limited number of high acoustic power frames into the ultrasound imaging sequence.

The Flash frames are intended to clear the imaging plane of microbubbles, allowing you to observe dynamic microbubble replenishment.

**Flash** is available in live imaging only. Press the **Flash** button to activate the delivery of the flash sequence.



## CEUS ACOUSTIC POWER

**CEUS Acoustic Power** regulates the output power of the system delivered to the CEUS image.

Generally, very low acoustic power levels are used to avoid the unwanted destruction of fragile microbubble contrast agents.

**CEUS Acoustic Power** is available only in live imaging.



Rotate the knob located under **Acoustic Power**:

- clockwise to increase acoustic power output
- counterclockwise to decrease acoustic power output

Maximum acoustic power is 0dB and minimum is -30dB.

See [Chapter 3, Safety \[27\]](#) for information on output power regulations.

## FLASH POWER

**Flash Power** regulates the output power of the system delivered to the CEUS image when the Flash control is pressed.

Generally, the Flash power is set to a high acoustic power level and is delivered in a just a few frames. The high Flash acoustic power will destroy microbubbles in the CEUS image, allowing you to observe dynamic microbubble replenishment.

**Flash Power** is available only in live imaging.

Rotate the knob located under **Flash Power**:

- clockwise to increase acoustic power output
- counterclockwise to decrease acoustic power output

See [Chapter 3, Safety \[27\]](#) for information on output power regulations.

## CEUS DYNAMIC RANGE

**CEUS Dynamic R.** allows you to change the range over which the amplitudes of returning ultrasound signals are displayed in the CEUS image.

**CEUS Dynamic R.** is available in live CEUS imaging and on a frozen CEUS image.

Rotate the rotary knob located under **CEUS Dynamic R.:**

- clockwise to compress the grayscale values
- counterclockwise to decrease the dynamic range



## CEUS MAP

**CEUS Map** assigns the display of the CEUS echo signals to a range of grayscale or chromatic colors.

**CEUS Map** is available in live CEUS imaging and on a frozen CEUS image.

Rotate the rotary knob located under **CEUS Map**:

- clockwise to view next map
- counterclockwise to view previous map



## FRAMES TO FLASH

**Frames to Flash** determines the number of high acoustic power frames which are delivered during the Flash sequence.

Rotate the knob to adjust the number of desired frames to flash.



## CEUS Scanning TIPS



### CEUS SCANNING

Optimize the B-mode image as usual. Then press CEUS

Select the Contrast Agent setting most appropriate for the microbubble contrast agent being used.

Administer an amount of contrast agent advised by the contrast agent manufacturer for the targeted application.

Press Save Clip, when agent arrives to capture prospectively the contrast bolus.

Use a low CEUS Acoustic Power to minimize microbubble destruction.

Adjust the Res/Pen control to optimize the image.

Adjust the HD/Fr. Rate control to optimize the image.

Allow the contrast agent to completely clear before administering the dose appropriate for diagnostic imaging.

Remember to start the Timer when injecting contrast agent!

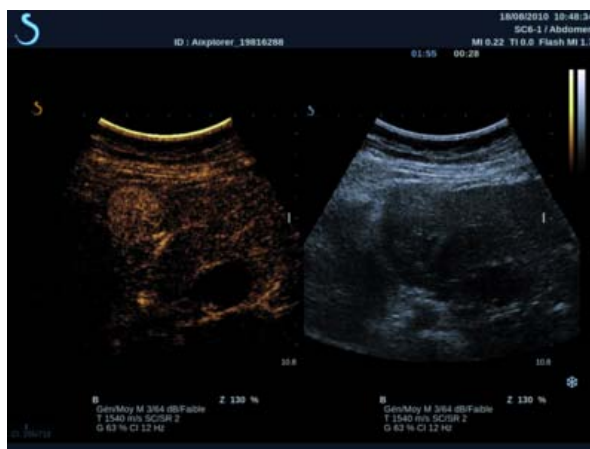

# M-Mode Imaging

## Accessing M-mode

Touch **M-mode** on the B-mode touch screen. The M-mode is accessible only if one of these presets has been selected: GYN, Early OB or Gen OB.



## About M-Mode Main Display

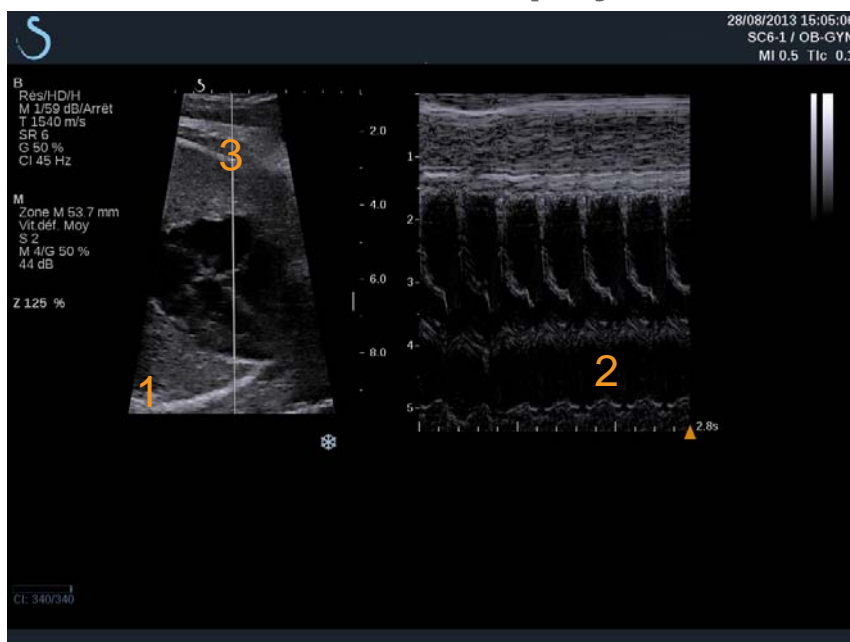

1. Grayscale image
3. M line

2. M-mode

## About M-Mode touch screen

When in M-mode, the touch screen displays various image settings which help you to optimize your M-mode image.

There are two pages of M-mode parameters. These settings are controlled by touching the control on the touch screen or turning the rotary knob directly below it.





You can navigate through the pages by touching **Other Settings**.

## Setting Up M-mode

### M-LINE

Move the **trackball** left and right to move the M-line in the 2D image.



### M-ZONE POSITION

Move the **trackball** up and down to move the M-zone on the M-line.

### M-ZONE SIZE

Slide your finger on the **TouchRing™** to change the size of the M-zone.



## Description of M-mode Imaging Parameters

### RES/PEN



**Res/Pen** allows you to change center frequency to obtain increased resolution or increased penetration. **Res/Pen** is available only in live imaging. Press **Res/Pen** to change value.

The orange LED indicates which one is the active value:

- Left LED: Res (resolution)
- Middle LED: Gen (general)
- Right LED: Pen (penetration)

### ACOUSTIC POWER



**Acoustic Power** indicates the output acoustic power. **Acoustic Power** is available only in live mode.

Rotate the knob located under **Acoustic Power**:

- clockwise to increase acoustic power
- counterclockwise to decrease acoustic power

**Acoustic Power** values vary from 0dB (maximum power) to -20dB (minimum power).

### M DYNAMIC RANGE

You can optimize the M-mode dynamic range as follows:

Rotate the knob located under **M Dynamic Range**:

- clockwise to increase the dynamic range
- counterclockwise to decrease the dynamic range





## CONTRAST

Contrast is a display threshold of the M-mode.

Rotate the knob located under **Contrast**:

- clockwise to darken anechoic areas
- counterclockwise to brighten anechoic areas



## DISPLAY FORMAT

**Display Format** is available in live imaging and on a frozen image.

Press **Display Format** to change its value.

3 display formats are available:

- $\frac{1}{2}$  B-mode and  $\frac{1}{2}$  M-mode display
- $\frac{2}{3}$  B-mode and  $\frac{1}{3}$  M-mode display
- side by side display



## M MAP

**M Map** is available in live imaging and on a frozen image.

Rotate the knob located under **M Map**:

- clockwise to go to previous map
- counterclockwise to go to next map



## SWEEP SPEED

**Sweep Speed** allows you to change the speed with which the M-mode columns are updated on the display.

**Sweep Speed** is available in live imaging and on a frozen image.

Touch **Sweep Speed** until you reach the desired value.



## SMOOTHING



**Smoothing** is a spatial filter used to smooth the M-mode in order to provide a more homogeneous appearance.

**Smoothing** is available only in live imaging.

Rotate the knob located under **Smoothing**:

- clockwise to increase smoothing
- counterclockwise to decrease smoothing

## M-mode Scanning TIPS



### M-MODE SCANNING

The M-mode will represent movements of structures along one line over time.

Initially a B-mode image is acquired.

Optimize the grayscale image by adjusting the image depth and zoom factor, and by setting the appropriate focal zone (position and spread).

Other optimization controls shall be used as necessary such as the AutoTGC, the B-mode map, the overall gain and the dynamic range.

Activate the M-mode with the dedicated button on the touch screen.

Set the proper size and positioning of the M zone.

Decrease the gain to eliminate background noise.

The M-mode has a good temporal resolution, and the sweep speed may be adjusted if needed to match the speed of the movements that are observed.

The display format can be changed to match the user's working conditions.

# Analyzing an Image

## Using Body Markers

### How to Use Body Markers



**Body Mark.** is available in live imaging and on frozen image.

**Body Mark.** is located on the control panel.

Press **Body Mark.** to add a body marker to an image.

The default body marker will appear on the on the touch screen and on the main monitor display to the lower right of the image.



Touch **PICTO** to change the body marker pictogram.

A selection of body markers appears on the touch screen.

Touch the desired body marker to select it.

The transducer orientation can be indicated directly on the pictogram.

To add a transducer orientation to the pictogram, simply touch the pictogram to indicate the edge of the transducer that corresponds to the orientation marker on the transducer.

Then touch the pictogram again to indicate the edge of the transducer opposite the orientation marker. The transducer orientation appears.

Use the **Rotate** knob to rotate the transducer orientation on the body marker.



Press **Exit** on the touchscreen to close the Body Marker page.

Touch **HIDE** to hide the picto on the image.

To restore a body marker to the main display, touch **SHOW**.

## Customization

You can customize the body marker libraries in the system configuration.

You can choose to display the body marker touch screen every time you press **Freeze**.

See [Chapter 8, Customizing the System \[337\]](#) for more information.





## Annotation Mode

When you add an annotation as a title, it will remain when you unfreeze the image.

When you add an annotation as a free annotation, it will be removed when you unfreeze the image.

Press **Mode** to change the annotation mode.

## Group of Annotations

Annotations can be grouped by color. If they have a specific color, they belong to the same group. When you select a first annotation from a group, it will be added to the screen. When you select an annotation from the same group, it will replace the one that is already on the screen, if it is from the same group.

Annotations on transparent (blue) buttons do not belong to a given group. Therefore they will not be replaced.

Annotations all appear in white when the image is saved or printed.

## Moving annotations

You can move the annotations added to the screen:

1. Select an **annotation** from the touch screen to add it
2. Move the **cursor** over the newly added annotation
3. Press **Select**
  - The annotation is selected
4. Move the **cursor** where you want to move the annotation
5. Press **Select** to release the annotation



### NOTE

If you move an annotation over an existing annotation, the existing annotation will be replaced.



## Annotation Library

You can edit the library of pre-programmed annotations by manually entering your own annotations.

Touch **EDIT LIB.** to edit the library of annotations.

This opens the System Configuration page, the System/Display tab, and Annotation sub-tab.

Here you can manage the annotations for the desired clinical application.

See [Chapter 8, Customizing the System \[337\]](#) for more details.



## Set Home

Touch **Set Home** to define the current position of the cursor as the Home position for the current display format.



## Home

Touch **Home** to move the annotations cursor to the home position.

The cursor will move to the home position.

Touch **EXIT** to exit annotations.



### NOTE

When annotating the Dual screen, exit the annotation touch screen before updating the image with the **Select** key.

## Customization

You can choose to display the annotation touch screen every time you press **Freeze**.



See **Chapter 8, *Customizing the System* [337]** for more information.

# Performing Measurements

## Accessing Measurements

You can perform measurements to assess the dimension, area, perimeter, or volume of anatomical features.

Two types of measurements are available on Aixplorer®:

- Basic measurements, which can be done with a set of measurement tools
- Labeled measurements, which correspond to the actual anatomy of the body. Labeled measurements are not linked to an image. They appear in the report even if the image on which they were performed is deleted.

Press **Meas.** on the control panel to enter the measurement mode. A default caliper appears on the main display.

Note that the image area is duplicated on the touch screen to facilitate stylus measurements.

Measurements that appear with a star (\*) are estimated measurement results.



## Basic Measurements

Touch **Meas. Tools** on the touch screen.

The system displays the measurement tools that are available for the active mode.

Measurement results are displayed in the Measurement Result Area which is located to the lower right of the image, below the grayscale bar, on the main display.

Touch the desired measurement tool:

### DISTANCE

**Distance** is available in all modes.



### **Method 1:** with the Trackball and Select

1. Touch **Distance**.
2. Use the **trackball** to move the active cursor to the first measurement point.
3. Press **Select** to anchor the first point.

The system anchors the first cursor and displays a second active cursor.

The system displays the value of distance in the measurement result area to the right of the image on the main display.

4. Touching **End** will end the measurement.

### **Method 2:** with the Touch Screen

1. **Touch Distance**.

The active cursor appears.

2. Touch the image on the touch screen where you want to anchor the first cursor.

The system moves the cursor to the position indicated, anchors the first cursor, and displays a second active cursor.

3. Touch the image on the touchscreen where you would like to position the second cursor.
4. Touch **End** to anchor the second cursor.

It is possible to combine the approaches of Method1 and Method2 to optimize the measurement workflow.

## ELLIPSE

**Ellipse** is available in all modes.

### **Method 1:** with the Trackball and Select

1. Press **Select** to anchor the first point.

The system anchors the first cursor and displays a second active cursor.

2. Use the **trackball** to move the active cursor to the second point of measurement.
3. Press **Select** to anchor the second cursor.

The system displays an ellipsoid trace between the two points.

4. Use the **trackball** to adjust the shape of the ellipse.
5. Pressing **Select** will sequentially arbitrate control to the first cursor, second cursor and ellipse trace.
6. Touch **End** to complete the measurement.

### **Method 2:** with the Touch Screen

1. Touch **Ellipse**.

The active cursor appears.

2. Touch the image on the touch screen where you want to anchor the first cursor.

A second cursor will automatically appear.

3. Without lifting the finger or stylus, drag the second active cursor along the axis of the ellipse.

The system displays an ellipsoid trace between the two points.

Lifting the stylus or finger will anchor the second cursor.

4. Touch the image near the opposite axis of the ellipse.
5. Without lifting the finger or stylus, drag the ellipse trace to the desired position.
6. Touch **End** to complete the measurement.

It is possible to combine the approaches of Method1 and Method2 to optimize the measurement workflow.

## TRACE

**Trace** is available in all modes.

### **Method 1:** with the Trackball and Select

1. Touch **Trace**.

2. Use the **trackball** to move the active cursor to the first measurement point.
3. Press **Select** to anchor the first point.

The system anchors the first cursor and displays a second active cursor directly on top of the first.

4. The system anchors the first cursor and displays a second active cursor directly on top of the first.

The path will be displayed.

5. Press **Select** to anchor the second cursor.

The system will automatically connect the end points of the trace.

6. Alternately, touch **End** to complete the measurement.

If the start and end points of the trace become very near to each other, the system will automatically close the trace.

The knob under **Trace** can be used on an active trace to incrementally erase the trace in reverse and redo the trace.

## **Method 2:** with the Touch Screen

1. Touch Trace

The active cursor appears.

2. Touch the image on the touch screen where you want to anchor the first cursor.

A second cursor will automatically appear directly on top of the first.

3. Without lifting the finger or stylus, drag the second active cursor along the path of the desired trace.

The path will be displayed.

Lifting the finger will pause the trace.

Touching the cursor will reactivate the trace.

4. Touch **End** to complete the measurement.

If the start and end points of the trace become very near to each other, the system will automatically close the trace.

## VOLUME

A three distance volume allows you to use three independent distances in the same or in orthogonal images to create a volume calculation.

To access volume calculation, press **Meas. Tools**.



1. Press **Volume**
2. Use your preferred method (see above, Distance measurements) to draw three distances
3. The system calculates a volume from the three distances

You can also calculate a volume with labeled measurements. See [the section called “Labeled Measurements” \[272\]](#).

## HIP ANGLE

Hip Angle allows you to calculate the angles between the roof line and the baseline ( $\alpha$ ), and between the inclination line and the baseline ( $\beta$ ).

To access hip angle calculation, press **Meas. Tools**.



1. Press **Hip Angle**
2. Draw the baseline as a regular distance
3. Draw the roof line as a regular distance  
 $\alpha$  is calculated.
4. Draw the inclination line as a regular distance  
 $\beta$  is calculated.

D:D

**d:D** allows you to calculate the coverage of the femoral head by the bony acetabulum.



To access femoral head coverage calculation, press **Meas. Tools**.

1. Use the **Trackball** to position the circle at the center of the femoral head
2. Press **Select**
3. Use the **Trackball** to resize the circle to fit the femoral head  
D is calculated.
4. Draw the baseline as a regular distance  
d is calculated.  
The d:D ratio is calculated.

## IMT

IMT calculates the Intima Media Thickness of a region of interest.

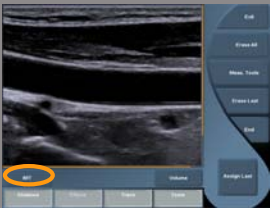

Press **IMT** to start the measurement.

A box of interest is displayed on the image, the intima and media are automatically traced within the box of interest, and the IMT measurement is displayed in the measurement result area.

- **IMT** indicates the Intima Media Thickness
- **W** indicates the width of the box of interest
- **Fit** indicates the percentage of the box of interest for which the IMT is calculated



Use the **Trackball** to move the box of interest.

Press **Select** on the control panel to be able to resize and rotate the box of interest. The box of interest is outlined with a dotted line.

Use the **Trackball** to resize the box of interest.

Use the **TouchRing™** to rotate the box of interest.

Press **Select** again to exit the resize/rotate mode.

You have access to various parameter to optimize the IMT calculation:

## IMT Opt

Allows you to select between various detection algorithms, as a function of the visually estimated IMT.

Rotate the knob under **IMT Opt** to change its value.

## IMT Display

Rotate the knob under **IMT Display** to hide or show the IMT trace on the image.

## Zoom

Rotate the knob under zoom to zoom the image that is duplicated on the touch screen.

## Edition of the IMT trace

You may want to slightly change the IMT trace.

1. Press **Edit Intima** or **Edit Media** as needed
2. Move the cursor to modify the trace
3. Turn off **Edit Intima** or **Edit Media** to exit the edition of the IMT trace

## Manual Redefine

You may want to manually draw the IMT trace.

1. Press **Manual Redefine**
2. Press **Redefine Intima** or **Redefine Media** as needed
3. The Intima or Media trace is erased a cursor appears
4. Move the cursor to manually draw the Intima or Media
5. Press **Exit Manual Redefine** to exit the Manual Redefine mode

Draw backwards to erase the trace.



Press **Exit IMT** to exit.

## % DIAMETER REDUCTION

This tool allows you to compare the diameter of the unreduced vessel to the diameter of the stenotic or reduced lumen.

1. Press **% Diam Reduction**
2. Move the cursor at the first point of the residual diameter
3. Press **Select** to anchor it
4. Move the next cursor to the second point of the residual diameter
5. Press **Select** to anchor it
6. Move the next cursor to the first point of the vessel diameter
7. Press **Select** to anchor it
8. Move the next cursor to the second point of the vessel diameter
9. Press **Select** to complete the measurement

The system calculates the vessel diameter, the residual diameter, and the reduction between the two.

## % AREA REDUCTION

This tool allows you to compare a cross-sectional outline of the unreduced vessel to a tracing of the stenotic or reduced lumen.

1. Press **% Area Reduction**
2. Move the cursor to the first point of the residual area
3. Press **Select** to start drawing
4. Move the Trackball to draw the residual area
5. Press **Select** to validate
6. Move the next cursor to the first point of the vessel area
7. Press **Select** to start drawing
8. Press **Select** to complete the measurement

The system calculates the vessel area, the residual area, and the reduction between the two.





## DISTANCE RATIO

1. Press **Distance Ratio**
2. Perform a first distance measurement
3. Perform a second distance measurement  
The system calculates a ratio between the two distance measurements.

## DOPPLER TIME

This tool is available in UltraFast™ Doppler mode.

It allows you to calculate time shifts between 2 timelines and compare the temporal behaviors of multiple spectrograms.



1. Add spectrograms (see [the section called “Add Spectrogram” \[204\]](#))
2. Press **Meas Tools** on the touch screen
3. Press **Doppler Time**
4. Position the first timeline
5. Press **Select** to validate
6. Position the second timeline
7. Press **Select** to validate

The Doppler time shift is displayed in the measurement result area, in milliseconds.

## PW AUTOTRACE

See [the section called “PW Autotrace” \[217\]](#).

## VELOCITY

**Velocity** is available only in PW mode.



1. Touch **Velocity**.

A Vel caliper is displayed on the PW spectrum, together with a vertical axis and a horizontal axis.

2. Press **Velocity** to anchor the caliper.

The **Velocity** tool results in a Doppler Velocity (Vel) measurement (in cm/s) and a Pressure Gradient (PG) calculation (in mmHg).

### PSV/EDV

**PSV/EDV** is available only in PW mode.

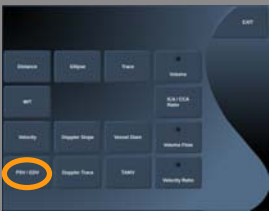

1. Touch **PSV/EDV**.

A first PSV caliper is displayed on the PW spectrum, together with a vertical and a horizontal axis.

2. Press **Select** to anchor it.

A second caliper is displayed, with the following label:

- EDV if the caliper is above the baseline
- MDV if the caliper is below the baseline

3. Press **Select** to anchor it.

The **PSV/EDV** tool results in the following:

- Peak Systolic Velocity (PSV)
- End Diastolic Velocity (EDV)
- Resistive Index (RI)
- Systolic to Diastolic Ratio (S/D)
- Peak Pressure Gradient (PG)

### VESSEL DIAMETER

**Vessel Diam** allows you to measure the diameter of a vessel.

**Vessel Diam** is available only in PW mode.



1. Touch **Vessel Diam.**  
A first caliper is displayed within the sample volume
2. Use the **Trackball** to resize the first part of the caliper
3. Press **Select** to anchor  
A second caliper is displayed within the sample volume
4. Use the **Trackball** to resize the second part of the caliper
5. Press **Select** to anchor.

## DOPPLER SLOPE

Doppler Slope allows you to measure the acceleration or deceleration slope on the Doppler spectrum.

**Doppler Slope** is available only in PW mode.



1. Touch **Doppler Slope.**  
A first caliper is displayed
2. Press **Select** to anchor the first caliper  
The system anchors the first caliper and displays a second active caliper
3. Use the **Trackball** to move the active caliper
4. Press **Select** to anchor the second caliper

## DOPPLER TRACE

**Doppler Trace** allows you to trace a single heart cycle on the Doppler spectrum.

**Doppler Trace** is available only in PW mode.

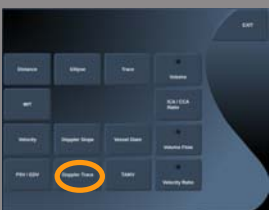

1. Touch **Doppler Trace.**
2. Use the **trackball** to move the active caliper to the first measurement point.
3. Press **Select** to anchor the first point.

The system anchors the first caliper and displays a second active cursor.

4. Use the **trackball** to move the active caliper along the desired path. The path will be displayed.
5. Press **Select** to anchor the second caliper.

## CONGESTION INDEX

Congestion Index allows you to calculate the ratio between the cross-sectional area ( $\text{cm}^2$ ) and the blood flow velocity ( $\text{cm/s}$ ) of the portal vein.

1. Adjust the **Angle correction** parallel to the portal vein
2. Press **Select** to update the PW spectrum
3. **Freeze** the image
4. Touch **Congestion Index**
5. Adjust the portal vein diameter by positioning the first and second caliper with the **Trackball** and **Select** button
6. Draw the Doppler trace during one cardiac cycle
7. Press **Select** to end the measurement

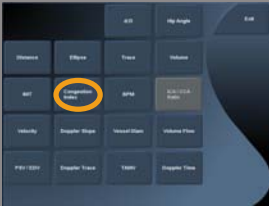

## BPM

This tool allows you to measure a heart rate from M-mode.

1. In M-mode measurement, touch **BPM**.  
A first vertical line is displayed.
2. Use the **trackball** to move the vertical line along the timeline.
3. Press **Select** to validate.  
A second vertical line is displayed.
4. Use the **trackball** to move the second vertical line along the timeline.
5. Press **Select** to validate.



## VOLUME FLOW

In PW mode, you have the capability to measure the volume flow rate within a vessel.



1. Adjust the Sample Volume size so that it covers the whole diameter of the vessel
2. Adjust the **Angle correction** parallel to the vessel
3. Press **Select** to update the PW spectrum
4. **Freeze** the image
5. Press **Meas.** on the Control Panel
6. Press **Volume Flow** on the Touch Screen
7. Adjust the vessel diameter by positioning the first and second caliper with the **Trackball** and **Select** button
8. Draw the Doppler trace during one cardiac cycle
9. Press **Select** to end the measurement  
The system displays the volume flow rate.

When the **Autotrace** is on:

1. Press **Volume Flow**
2. Adjust the vessel diameter by positioning the first and second caliper with the **Trackball** and **Select** button

The system displays the volume flow rate.

## ICA/CCA RATIO

After having performed ICA and CCA labeled measurements, you can calculate the ICA/CCA ratio.

1. In PW mode, press **Meas.** on the control panel  
The list of labeled measurements appear on the right
2. Click on **Left** or **Right** as needed  
The list of labeled measurements is filtered by laterality



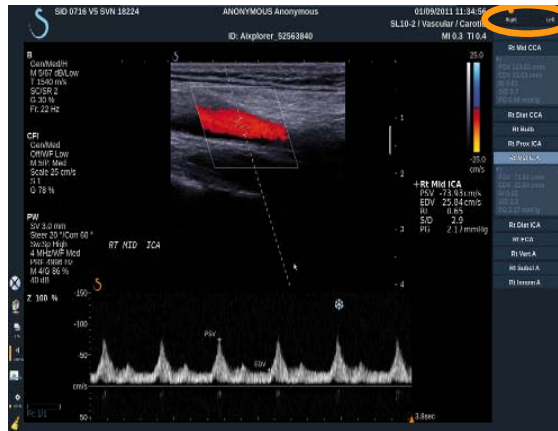

3. Perform ICA and CCA labeled measurements
4. Press **Meas Tools**
5. Press ICA/CCA ratio
 

The touch screen displays a table of results for the performed ICA and CCA measurements.
6. Touch the desired ICA and CCA measurement results for which you want the system to calculate the ratio
7. Press **Validate** on the touch screen to validate the ratio

## M DISTANCE

This tool allows you to measure a vertical distance between two calipers. It is similar to a distance measurement in B-mode.



1. In M-mode measurement, touch **M Distance**.
 

A first caliper is displayed.
2. Use the **trackball** to move the first caliper
3. Press **Select** to validate.
 

A second caliper is displayed.
4. Use the **trackball** to move the second caliper
5. Press **Select** to validate.

## Q-BOX™

The Quantification Box (Q-Box™) allows you to accurately quantify the stiffness of an area.

**Q-Box™** is available only in SWE™ mode, on a frozen image.

### 1. Touch **Q-Box™**

Q-Box™ displays a circle that can be resized or moved, and that is duplicated on the B-mode image (in side by side and top bottom formats), for reference purposes.

### 2. Select to anchor it.



## Q-BOX™ RATIO

**Q-Box™ Ratio** allows you to compare the stiffness of two areas on the same image.

**Q-Box™ Ratio** is available only in SWE™ mode, on a frozen image.

### 1. Touch **Q-Box™ Ratio**.

**Q-Box™ Ratio** displays a circle that can be resized or moved, and that is duplicated on the B-mode image (in side by side and top bottom formats), for reference purposes.

### 2. Place the **Q-Box™** within the stiffest visualized area

### 3. Press **Select** to anchor it

### 4. Another **Q-Box™** is displayed.

### 5. Place it on soft tissue.

### 6. Press **Select** to anchor it.



## Q-BOX™ TRACE

**Q-Box™ Trace** allows you to manually trace a Q-Box in SWE imaging mode in order to obtain some elasticity values within the traced area.

**Q-Box™ Trace** is available only in SWE™ mode, on a frozen image.



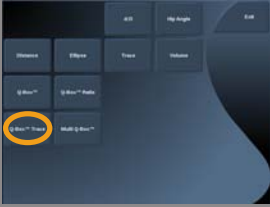

1. Touch **Q-Box™ Trace**
2. Use your preferred method (with the Trackball, or with the touchscreen, see [the section called “Trace” \[256\]](#)) to draw a trace
3. Press **Select** to end the measurement

## MULTI Q-BOX™

**Multi Q-Box™** allows you to automatically calculate the average of several Q-Box measurements.

**Multi Q-Box™** is available only in SWE™ mode, on a frozen image.



1. Touch **Multi Q-Box™**
2. Resize and move the Q-Box as needed
3. Press **Select** to validate  
The system calculates the average of each Q-Box result.  
You can continue the Multi Q-Box measurement cycle on several images.
4. Press **End** to end the Multi Q-Box measurement cycle

## Other Touch Screen measurement functionalities

The measurements touch screen has some specialty controls to facilitate measurement workflow.

### ERASE ALL

**Erase All** allows you to erase all of the measurements displayed on the frozen image.

### ERASE LAST

**Erase Last** allows you to erase only the last caliper anchored.

### END

**End** will end the active measurement.

### UNDO/REDO

The knob under **Undo/Redo** can be used on an active trace to incrementally erase the trace in reverse and redo the trace.

### ZOOM

**Zoom** allows you to enlarge the size of the image area displayed on the touch screen.

Rotate the knob located under **Zoom**:

- clockwise to increase the zoom factor
- counterclockwise to decrease the zoom factor

Use “Fit” to fit the image in the touch screen measurement area.

## ASSIGN LAST

**Assign Last** allows you to assign the last measurement performed to a label.

1. Perform a measurement
2. Touch Assign Last on the touch screen  
The system displays the list of available labels for your measurement
3. Click on the desired label

For more information on labeled measurements, refer to [the section called “Labeled Measurements” \[272\]](#)

## EXIT

**Exit** completes any active measurements, closes the measurements touch screen and returns to the frozen image state.

## Labeled Measurements



Press **Meas.** on the control panel.

A list of labeled measurements is displayed on the right side of the image.

The available labels depend on the selected application and on the current active mode.

The label packages can be configured in the System Configuration. See [the section called “Packages” \[372\]](#).



Press **Pointer.**

To scroll the list, place the **Pointer** over it, and use the **TouchRing™**.

Pick the appropriate label from the list by pressing **Select.**

The appropriate measurement tool is launched (distance...).

Perform the measurement as for a basic measurement.

You can make up to 5 measurements for the same label. They appear with their corresponding caliper in the list.

Note: Labeled measurements may be hidden, depending on the selected option from the system configuration.

## Measurement Customization

You can customize the measurements in the system configuration.

You can choose to display the measurement touch screen every time you press **Freeze.**

See [Chapter 8, \*Customizing the System\* \[337\]](#) for more information.

# Measurement Accuracy

## 2D MEASUREMENTS

The table below shows the measurement accuracy and range for the 2D measurements available on the ultrasound system.

Measurement Type	Accuracy	Range	Notes
Axial Distance	±10% or 1 mm	0.01 to 25 cm	Whichever is larger
Lateral Distance	±10% or 2 mm	0.01 to 20 cm	Whichever is larger
Diagonal Distance	±10% or 2 mm	0.01 to 25 cm	Whichever is larger
Area	±10% or 25 mm <sup>2</sup>	0.01 to 1000 cm <sup>2</sup>	Whichever is larger *Continuous trace accuracy depends on user.
Perimeter	±10% or 5 mm	0.03 to 10,000 cm	Whichever is larger *Continuous trace accuracy depends on user.
Ellipsoid Volume	±10%	0.01 to 2000 cm <sup>3</sup>	Whichever is larger

*\*The tolerances specified apply only to measurements made in a homogeneous medium with a speed of sound of 1540 m/s and with a non-refractive surface and with insonification angle of 90 degrees relative to the surface of the transducer.*

## PANORAMIC DISTANCE MEASUREMENT

Metric	Specification	Test Level	Notes
Transducer Name / Preset	SL15-4 / General	I	1
Geometry	Linear	I	1
Nominal Center Frequency	8.5 MHz	I	1,2
Imaging Frequency Range	4.0 – 15.0 MHz	I	1,2

Metric	Specification	Test Level	Notes
Panoramic Distance Measurement Accuracy	± 10%	M	3

Metric	Specification	Test Level	Notes
Transducer Name / Preset	SL10-2 / General	I	1
Geometry	Linear	I	1
Nominal Center Frequency	6.0 MHz	I	1,2
Imaging Frequency Range	2.0 – 10.0 MHz	I	1,2
Panoramic Distance Measurement Accuracy	± 10%	M	3

### Explanation of symbols used in the Panoramic Distance Measurements tables

**Test Level I:** Verified by inspection or qualitative analysis.

**Test Level M:** Verified by measurement.

**Note 1:** Specification is for information purposes only, and is not a testable requirement at the system level.

**Note 2:** Specification refers to the ultrasound pulses used in the imaging part of the B-mode sequence.

**Note 3:** The Panoramic distance measurement accuracy test is performed using the ATS 551 Small Parts phantom and covers a maximum distance of approximately 20 cm.

## M-MODE MEASUREMENTS

Metric	Specification	Test Level	Notes
Transducer Name / Preset	SC6-1 / OB	I	1
Geometry	Curved	I	1
Nominal Center Frequency	3.5 MHz	I	1,2
M-mode TX/ RX Frequency	2.5/4.5 MHz	I	1,2
Axial Distance Measurement Accuracy	± 10% or 1mm	M	3, Whichever is greater
Heart Rate Measurement Accuracy	± 10%	M	4

Metric	Specification	Test Level	Notes
Transducer Name / Preset	SE12-3 / OB	I	1
Geometry	Curved	I	1
Nominal Center Frequency	7 MHz	I	1,2
M-mode TX/ RX Frequency	3.75/7.5 MHz	I	1,2
Axial Distance Measurement Accuracy	± 10% or 1mm	M	3, Whichever is greater
Heart Rate Measurement Accuracy	± 10%	M	4

### Explanation of symbols used in the M-mode Measurements tables

**Test Level I:** Verified by inspection or qualitative analysis.

**Test Level M:** Verified by measurement.

**Note 1:** Specification is for information purposes only, and is not a testable requirement at the system level.

**Note 2:** Specification refers to the ultrasound pulses used in the M-mode sequence.

**Note 3:** The M-mode distance measurement accuracy test is performed using the CIRS Model 040GSE phantom.

**Note 4:** The fetal heart rate timing accuracy is measured using the following material: AWG Agilent 33220A Oscilloscope Tektronix DPO4034 Ultrasound Gel Pad Aquaflex Ref. 04-02 HI-FI speaker Monacor SP60/4.



## DOPPLER MEASUREMENTS

Doppler measurement calipers are positioned on a single pixel in a desired location.

Velocity measurements are displayed in units of cm/s or m/s with at least 1 digit past the decimal point.

The table below shows the measurement accuracy, range and tolerance for the Doppler measurements available on the ultrasound system.

Doppler Measurement	System Tolerance (whichever is greater)	Accuracy based on	Range[r]
Velocity measurement	<15% relative error	Acquisition	PW:6.2cm/s - 370cm/s

*The tolerances specified apply only to measurements made in a homogeneous medium with a speed of sound of 1540 m/s and with a non-refractive surface and a Doppler angle of 0°. These accuracies arise from the positioning of the cursors on the Doppler display and the subsequent measurements made.*

### Measurement Doppler Accuracy and Sensitivity Summary for the transducers

Items marked by a dagger (†) indicate that the specified value is for information purposes only and is not a testable requirement at the system level.

**Test Level I:** verified by inspection or analysis

**Test Level M:** verified by measurement

† : for reference only

(1) Transmitter center frequencies for grayscale imaging

(2) Using CIRS 043 Doppler string phantom.

Metric (Notes)	Specification	Test Level
Transducer Name / Preset	SL15-4/ Breast	I

Metric (Notes)	Specification	Test Level
Geometry †	Linear	
Nominal Center Frequency	8.5 MHz	
PW Doppler Center Frequency	5MHz	I
PW Doppler Spectral Velocity accuracy (2)	=12.5% error	M

*Doppler Velocity Accuracy measurements in Aixplorer® for the SL15-4 transducer.*

Metric (Notes)	Specification	Test Level
Transducer Name / Preset	SC6-1/Abdomen	I
Geometry †	Curved	
Nominal Center Frequency	3.5 MHz	
Imaging Frequency Range (1)	1.0 – 6.0 MHz	I
PW Doppler Center Frequency	2.25 MHz	M
PW Doppler Spectral Velocity accuracy (2)	=13% error	M

*Doppler Velocity Accuracy measurements in Aixplorer® for the SC6-1 transducer.*

Metric (Notes)	Specification	Test Level
Transducer Name / Preset	SE12-3/Prostate	I
Geometry †	Micro-convex	
Nominal Center Frequency	7 MHz	
Imaging Frequency Range (1)	3 - 12 MHz	I
PW Doppler Center Frequency	4.5 MHz	M
PW Doppler Spectral Velocity accuracy (2)	=15% error	M

*(1) Transmitter center frequencies for grayscale imaging*

*Doppler Velocity Accuracy measurements in Aixplorer® for the SE12-3 transducer.*

Metric (Notes)	Specification	Test Level
Transducer Name / Preset	SLV16-5 / Breast	I
Geometry †	Motorized	
Nominal Center Frequency	8.5 MHz	
Imaging Frequency Range (1)	5 - 16 MHz	I
PW Doppler Center Frequency	5 MHz	M
PW Doppler Spectral Velocity accuracy (2)	=5% error	M

*(1) Transmitter center frequencies for grayscale imaging*

*Doppler Velocity Accuracy measurements in Aixplorer® for the SLV16-5 transducer.*

Metric (Notes)	Specification	Test Level
Transducer Name / Preset	SL10-2 / Vascular – Carotid	I
Geometry †	Linear	
Nominal Center Frequency	6 MHz	
Imaging Frequency Range (1)	4.5 - 15 MHz	I
PW Doppler Center Frequency	3.75 MHz	M
PW Doppler Spectral Velocity accuracy (2)	=3% error	M

*(1) Transmitter center frequencies for grayscale imaging*

*Doppler Velocity Accuracy measurements in Aixplorer® for the SMC12-3 transducer.*

Metric (Notes)	Specification	Test Level
Transducer Name / Preset	SMC12-3 / General – Vascular	I

Metric (Notes)	Specification	Test Level
Geometry †	Micro-convex	
Nominal Center Frequency	7.5 MHz	
Imaging Frequency Range (1)	3-12 MHz	I
PW Doppler Center Frequency	4.5 MHz	M
PW Doppler Spectral Velocity accuracy (2)	=14.5% error	M

*(1) Transmitter center frequencies for grayscale imaging*

*Doppler Velocity Accuracy measurements in Aixplorer® for the SMC12-3 transducer.*

## COLOR FLOW DOPPLER SENSITIVITY:

The purpose of this test is to measure the penetration of color flow imaging performance.

Each transducer is placed in Color Flow.

The Color Flow Doppler Phantom equipped with a 4 mm diameter sloping cylindrical vessel is imaged to measure the Color Doppler Sensitivity in centimeters.

The inclination angle is 30°.

The maximal depth (penetration) at which the Doppler signal can be detected on the display is measured using the calipers with one caliper at skin line and the other where the color flow signal starts to show dropouts.

The distance between them is considered to be the penetration.

The flow signals that fall below the threshold are considered to be noise and are not valid Color Doppler signals.

The Color Flow Doppler Phantom is used with a constant flow waveform.

(1) Transmitter center frequencies for grayscale imaging

(2) Using Shelley medical accuFlow-Q pump with QATP — 100/Z Model (Zerdine™ tissue mimicking material speed of sound 1540 m/s ± 6 m/s at 22°C, attenuation coefficient 0.5 dB/cm/MHz) blood flow phantom set at minimal, maximal, and midrange Doppler mean velocities output.

Metric (Notes)	Specification	Test Level
Transducer Name / Preset	SL15-4/ Breast	I
Geometry †	Linear	
Nominal Center Frequency	8.5 MHz	
Imaging Frequency Range (1)	4.0 – 15 MHz	I
Color Flow Frequency Range	5-9 MHz	M
Color Penetration (2)	≥4.0 cm	M

Metric (Notes)	Specification	Test Level
Transducer Name / Preset	SC6-1/Abdominal	I

Metric (Notes)	Specification	Test Level
Geometry †	Curved	
Nominal Center Frequency	3.5 MHz	
Imaging Frequency Range (1)	1.0 – 6.0 MHz	I
Color Flow Frequency Range	1.9 - 3.8 MHz	M
Color Penetration (2)	≥14.0 cm	M

Metric (Notes)	Specification	Test Level
Transducer Name / Preset	SE12-3/ Prostate	I
Geometry †	Micro-convex	
Nominal Center Frequency	7.5 MHz	
Imaging Frequency Range (1)	3 - 12 MHz	I
Color Flow Frequency Range	4.5 - 7.5 MHz	M
Color Penetration (2)	5.0 cm	M

Metric (Notes)	Specification	Test Level
Transducer Name / Preset	SLV16-5/	I
Geometry †	Motorized	
Nominal Center Frequency	8.75 MHz	
Imaging Frequency Range (1)	5 - 16 MHz	I
Color Flow Frequency Range	5 - 9 MHz	M
Color Penetration (2)	4.0 cm	M

Metric (Notes)	Specification	Test Level
Transducer Name / Preset	SL10-2/LowExtVenous	I
Geometry †	Linear	
Nominal Center Frequency	6 MHz	
Imaging Frequency Range (1)	4.5 to 15 MHz	I
Color Flow Frequency Range	3.7 to 6.4 MHz	M

Metric (Notes)	Specification	Test Level
Color Penetration (2)	84 mm	M

Metric (Notes)	Specification	Test Level
Transducer Name / Preset	SMC12-3/ Vascular	I
Geometry †	Micro-convex	
Nominal Center Frequency	7.5 MHz	
Imaging Frequency Range (1)	3 - 12 MHz	I
Color Flow Frequency Range	4.5 - 7.5 MHz	M
Color Penetration (2)	5.0 cm	M

*(1) Transmitter center frequencies for grayscale imaging*

## ELASTOGRAPHY MEASUREMENTS

### SWE Penetration and Spatial Resolution

The tables below document the penetration depth, and SWE spatial resolution specifications for all transducers where the SWE mode is available.

Metric	Specification	Test Level	Notes
Transducer Name / Preset	SLV16-5 / General	I	1
Geometry	Linear	I	1
Nominal Center Frequency	8.8 MHz	I	1, 2
Imaging Frequency Range	5.0 – 16.0 MHz	I	1, 2
SWE Penetration Depth Range	2.5 - 28 mm	M	4
SWE Spatial Resolution	2.0 mm	M	5

Metric	Specification	Test Level	Notes
Transducer Name / Preset	SL15-4 / General	I	1
Geometry	Linear	I	1
Nominal Center Frequency	8.5 MHz	I	1, 2
Imaging Frequency Range	4.0 – 15.0 MHz	I	1, 2
SWE Penetration Depth Range	2.5 - 30 mm	M	4
SWE Spatial Resolution	2.0 mm	M	5

Metric	Specification	Test Level	Notes
Transducer Name / Preset	SL10-2 / General	I	1
Geometry	Linear	I	1



Metric	Specification	Test Level	Notes
Nominal Center Frequency	6.0 MHz	I	1, 2
Imaging Frequency Range	2.0 – 10.0 MHz	I	1, 2
SWE Penetration Depth Range	2.5 - 45 mm	M	4
SWE Spatial Resolution	2.0 mm	M	5

Metric	Specification	Test Level	Notes
Transducer Name / Preset	SE12-3 / General	I	1
Geometry	Micro-curved linear	I	1
Nominal Center Frequency	7.5 MHz	I	1, 2
Imaging Frequency Range	3.0 – 12.0 MHz	I	1, 2
SWE Penetration Depth Range	2.5 - 30 mm	M	4
SWE Spatial Resolution	2.0 mm	M	5

Metric	Specification	Test Level	Notes
Transducer Name / Preset	SMC12-3 / General	I	1
Geometry	Micro-curved linear	I	1
Nominal Center Frequency	7.5 MHz	I	1, 2
Imaging Frequency Range	3.0 – 12.0 MHz	I	1, 2
SWE Penetration Depth Range	2.5 - 30 mm	M	4
SWE Spatial Resolution	3.0 mm	M	5

Metric	Specification	Test Level	Notes
Transducer Name / Preset	SC6-1 / General	I	1

Metric	Specification	Test Level	Notes
Geometry	Curved linear	I	1
Nominal Center Frequency	3.5 MHz	I	1, 2
Imaging Frequency Range	1.0 – 6.0 MHz	I	1, 2
SWE Penetration Depth Range	25 - 75 mm	M	4
SWE Spatial Resolution	3.0 mm	M	5

## Explanation of symbols used in the SWE penetration and spatial resolution tables

**Test Level I:** Verified by inspection or qualitative analysis.

**Test Level M:** Verified by measurement.

**Note 1:** Specification is for information purposes only, and is not a testable requirement at the system level.

**Note 2:** Specification refers to the ultrasound pulses used in the imaging part of the SWE sequence.

**Note 3:** The SWE maximum penetration depth is defined as the greatest depth for which the SWE image exhibits good color filling and minimal noise. The SLV16-5, SL15-4, SL10-2, SE12-3, SMC12-3 and SC6-1 SWE penetration depth ranges were derived by scanning regions of uniform-elasticity background material of the CIRS 049A QA Elasticity phantom.

**Note 4:** SWE spatial resolution is obtained by using a custom-made phantom containing rectangular tissue-mimicking blocks of different elastic contrast, and measuring the average width of the shear wave velocity vs. distance curves in the vicinity of the block interfaces in the lateral and axial directions.

## 3D MEASUREMENTS

Transducer	Mode TX/RX Frequencies	Depth (mm)	Transverse resolution (mm)	
SLV16-5	THI 5.625 / 11.25 MHz	20	-6dB	0.7
			-20dB	1.3

*3D transverse spatial resolution measurements for B-mode imaging for the SLV16-5*

The volume measurement accuracy is defined at  $\pm 10\%$  in the range of 0.01 to 2000cm<sup>3</sup>.

## BI-RADS® Analysis

The Breast Imaging Reporting and Data System (BI-RADS®), developed by the American College of Radiology, provides a standardized classification for ultrasound studies of the breast.

It is composed of a series of descriptors, from which an assessment linked to a category can be made by the physician.

### BI-RADS® Assessment Categories

BI-RADS® score	Assessment
0	Assessment incomplete: Need additional Imaging Evaluation
1	Negative
2	Benign finding
3	Probably benign finding
4	Suspicious abnormality
5	Highly suspicious of malignancy
6	Known biopsy-proven malignancy

The American College of Radiology BI-RADS® assessment categorization for ultrasound.

Note: all BI-RADS criteria are displayed in English on the system, regardless of the selected language.

You can easily perform BI-RADS® classification using the integrated BI-RADS® Lexicon Classification form.

Up to twelve lesions may be classified in a single study.

## Performing BI-RADS® Lexicon Classification



1. In any mode, **freeze** the image.
2. Touch **Add New Lesion**.  
A new lesion touch screen button will appear (e.g. Lesion A).
3. Using the **trackball**, position the lesion arrow marker to indicate the lesion of interest on the main display.
4. Press **Select** to anchor the arrow marker.  
The BI-RADS® menu will appear to the left of the image on the main display.

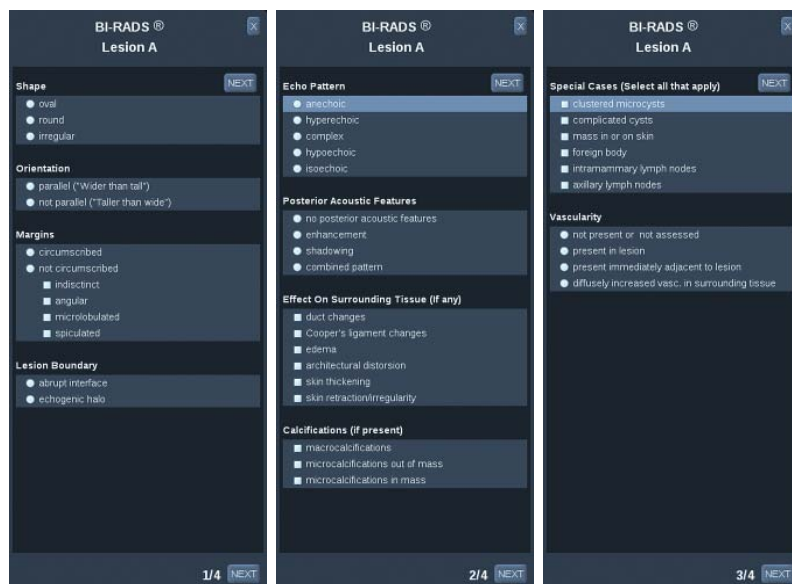

5. Select the results in the BI-RADS® lexicon classification form using the **pointer** and **Select** button
6. Click on the **NEXT** button in the menu or the **Lesion Page** control on the touch screen to move to the next page of the BI-RADS® menu.
7. Press **Save Image**.
8. Touch **Exit** to close the BI-RADS® menu.



## IMPORTANT NOTE

You must press **Save Image** after filling out the BI-RADS® classification form and exiting the menu or the data will not be saved.

The BI-RADS® menu can be accessed as many times as needed to complete the assessment for a particular lesion.

Measurements performed while in the BI-RADS® menu will be directly associated with the Lesion selected (e.g. Lesion A) in the final report.

Measurements performed in the BI-RADS® menu will appear on page 4.

## Documenting BI-RADS® Lexicon Classification with Images

A single image is not able to document all of the features contained in the BI-RADS® lexicon classification form.

To assist in documentation of lesion features, the integrated BI-RADS® menu offer you the advantage of documenting one or more BI-RADS® features with an associated image.

1. Define a new lesion and activate the BI-RADS® menu.
2. Using the pointer and **Select** button, results may be selected in the BI-RADS® lexicon classification form.
3. Press **Save Image**.

Note that the image number appears to the right of the selected answer on the BI-RADS® lexicon classification form.

4. You may exit BI-RADS® after each **Save Image** and return to the same lesion to enter additional data associated with new images.
5. In the case that disparate results are entered for the same lesion, reconciliation of results can be done in the Report (see [Chapter 6, Reports \[295\]](#)).

# Thy-RADS™ Analysis

The Thyroid Reporting and Data System (Thy-RADS™), developed by SuperSonic Imagine, provides a set of clinical assessment criteria for ultrasound studies of the thyroid.

You can easily perform Thy-RADS™ analysis using the integrated Thy-RADS form.

Up to 8 nodules may be classified in a single study.

## Performing Thy-RADS™ Lexicon Classification



1. In the Thyroid application, freeze the image.
2. Touch **Thy-RADS**.
3. Touch **Add new Nodule**.  
A new nodule touch screen button will appear (e.g. Nodule A).
4. Using the **trackball**, position the nodule arrow marker to indicate the nodule of interest on the main display.
5. Press **Select** to anchor the arrow marker.  
The Thy-RADS™ menu will appear to the left of the image on the main display.

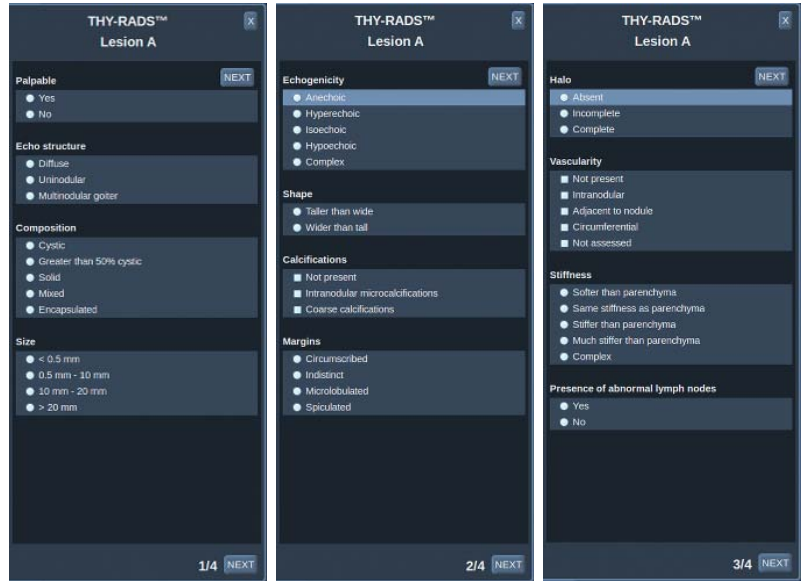

6. Select the results in the Thy-RADS™ lexicon classification form using **Pointer** and **Select** button
7. Click on the **NEXT** button in the menu or the **Nodule Page** control on the touch screen to move to the next page of the Thy-RADS™ menu.
8. Press **Save Image**.
9. Touch **Exit** to close the Thy-RADS™ menu.



## IMPORTANT NOTE

You must press **Save Image** after filling out the Thy-RADS™ classification form and exiting the menu or the data will not be saved.

The Thy-RADS™ menu can be accessed as many times as needed to complete the assessment for a particular nodule.

Measurements performed while in the Thy-RADS™ menu will be directly associated with the Nodule selected (e.g. Nodule A) in the final report.

Measurements performed in the Thy-RADS™ menu will appear on page 4.



## Documenting Thy-RADS™ Lexicon Classification with Images

A single image is not able to document all of the features contained in the Thy-RADS™ lexicon classification form.

To assist in documentation of lesion features, the integrated Thy-RADS™ menu offer you the advantage of documenting one or more Thy-RADS™ features with an associated image.

1. Define a new nodule and activate the Thy-RADS™ menu.
2. Using the **Pointer** and **Select** button, results may be selected in the Thy-RADS™ lexicon classification form.
3. Press **Save Image**.

Note that the image number appears to the right of the selected answer on the Thy-RADS™ lexicon classification form.

4. You may exit Thy-RADS™ after each **Save Image** and return to the same nodule to enter additional data associated with new images.
5. In the case that disparate results are entered for the same lesion, reconciliation of results can be done in the Report (see [Chapter 6, Reports \[295\]](#)).



# 6 Reports



# Description of the Report Feature

The Aixplorer® ultrasound system allows you to manage all the information collected during the study and generate a report.

The Report features is composed of two different views:

- the Report Builder, which allows you to create and customize the report
- the Report Preview, which allows you to view the report as it will be printed

Press **Report** to access the report feature.

The Report Builder is displayed.



## Report Builder

### Description of the Report Builder

The Report Builder allows you to choose which elements of the examination are to be included in the final report.

The Report Builder is composed of five tabs:

- **Patient Info**, where you can retrieve/edit patient information
- **Images**, where the images acquired during the exam, associated measurements, BI-RADS®/Thy-RADS™ and comments are stored
- **Measurements**, where you can view all the labeled measurements and calculations of the exam
- **Worksheet**, where you can use worksheets to locate the performed labeled measurements
- **Conclusion**, where you can add your conclusion of the exam



## Patient Information

The Patient Info tab displays the patient information, which is populated with the same information as the Patient Data screen.



As with the Patient Data screen, the **Patient Information** tab displays general information, as well as further information specific to each clinical application.

You can edit all the information from the Patient Information tab.

You can enter information in more than one tab if multiple exams have been performed.

If you press **Patient** to return to Patient Data entry, all your edits from the Report Builder will be saved and updated.

You can choose what information to show in the final report by using the Show/Hide Info icons:

- Selecting the **Show Info icon**  will designate that information to appear in the final report
- Selecting the **Hide Info icon**  will designate that information to not appear in the final report

Information which is hidden in the final report always remains part of the study as stored on the ultrasound system.

# Images

The **Images** tab in the Report Builder displays all of the images acquired in the exam.

The images are organized into clinical application tabs.

Vertical tabs are dedicated to images associated with BI-RADS® and Thy-RADS™ table.

You can choose which images to show in the final report by selecting them.

Click on the icon above the image to have it included in or excluded from the report.

Images which are not shown in the final report always remain part of the study as stored on the ultrasound system.

Next to each image is a text box designated for comments.

Select the white text box next to the image for which you want to add comments.

Enter comments using the **Keyboard**.



Measurements associated with each image are shown in the area to the right.

You can choose to show/hide the measurements in the final report by using the Show/Hide Info icons:

- Selecting the **Show Info icon** will designate the measurements to appear in the final report
- Selecting the **Hide Info icon** will designate the measurements to not appear in the final report

If no measurements were performed on the set of selected images, the region may appear empty.





## NOTE

For OB images on which measurements were performed, click on **GRAPH** to display the measurements on the reference OB table.

## Measurements

The **Measurement** tab allows you to view the labeled measurement results and associated calculations performed during the exam.

In this tab, you can show or hide each label measurement result in the final report.

1. Select the desired application sub-tab (available only for applications in which label measurements were performed during the exam).

Note that even if the image on which the labeled measurements were taken was deleted, the corresponding labeled measurements are kept in the database.

2. You can show or hide each labeled measurement result individually with the checkbox next to each measurement.

Hidden labeled measurement results will not appear in the final report.

For multiple instances of the same measurement, you can select which instance will be displayed in the report.

Click on the **+** to display all the sub-results of the performed measurements.

# Worksheet

The **Worksheet** tab displays the labeled measurements performed in the various applications on diagrams or in an interactive report:

- For the vascular application
- For the OB-GYN application

The **Worksheet** tab is divided in sub-tabs corresponding to the presets used to perform labeled measurements.

## Vascular Worksheet

### DESCRIPTION

The Vascular **Worksheet** displays the labeled measurements performed in the vascular application on diagrams.

### ADDING INFORMATION TO THE WORKSHEET

You can add some information to each worksheet such as scan quality or clinical findings.

1. Click on the text field next to the corresponding label

The keyboard automatically opens up

2. Type text to enter additional information

You can add labeled measurement results, annotations, plaque shapes and arrows to each worksheet.

1. Press **Toolbox** on the touch screen  
A window opens up on the main display
2. Click on the information you want to add.



## Add Result

1. Click on **Add Result** in the tool box  
The new result box is displayed
2. Press **Select Result** on the new result box
3. Choose a result from the list
4. Click on the result box and use the **Trackball** to move the result box if needed.

## Annotate

1. Press **Annotate** in the tool box  
  
An annotation box is displayed on the worksheet.
2. Use the keyboard to edit it
3. Click on the annotation and use the **Trackball** to move the annotation box if needed.
4. Double-click on the annotation box to rotate it if needed

Arrows are displayed around the annotation box.

5. Use the **TouchRing** to rotate the annotation box
6. Press **Select** to validate.

## Plaque Shape



1. Click on the plaque shape you want to add in the tool box
2. Click on the plaque shape and use the **Trackball** to move it if needed
3. Press **Select** to validate.
4. Double-click on the plaque shape to resize or rotate it if needed  
Arrows are displayed around the plaque shape.
5. Use the **TouchRing** to rotate the plaque shape
6. Press **Select** to validate.

## Add Arrow

1. Click on an element on the worksheet to link it to the diagram with an arrow
2. Press **Add arrow** in the tool box
3. Click on the added arrow
4. Use the **Trackball** to move the tip of the arrow to the selected location on the diagram
5. Press **Select** to validate.

## REMOVING INFORMATION FROM THE WORKSHEET

1. Click on the element you want to remove
2. Press **Toolbox** on the touch screen
3. Click on **Remove** on the tool box.

## ADDITIONAL INFORMATION SPECIFIC TO THE CAROTID WORKSHEET

The Carotid worksheet provides the SRU<sup>1</sup> and NASCET<sup>2</sup> criteria at the bottom of the worksheet.

Click on the elements that apply to the findings to add them to the worksheet.

## OB-GYN Worksheet

### DESCRIPTION

The OB-GYN **Worksheet** displays the labeled measurements performed in the OB-GYN application on an interactive report.

---

<sup>1</sup>Society of Radiologists in Ultrasound

<sup>2</sup>North American Symptomatic Carotid Endarterectomy Trial

## SELECTING MEASUREMENTS FROM THE WORKSHEET

Click on the measurement result on the Worksheet to change it.

## Conclusion

The **Conclusion** tab in the Report Builder is a free-form text entry screen.

Enter any final information or conclusions about the exam here.

You can choose to show the conclusion in the final report by using the Show/Hide Info icons:

- Selecting the **Show Info icon** will designate that conclusion to appear in the final report
- Selecting the **Hide Info icon** will designate that conclusion to not appear in the final report

# Generating Reports

You can generate various reports that will be saved in .pdf format and available from review:

- **Short Report** saves the list of labeled measurement results
- **Long Report** saves all available information for the current exam (images, worksheets, labeled measurements and conclusion)

1. Press **Short Report** or **Long Report** on the touch screen wheel.
2. Press **Generate Report** to generate the desired report in .pdf

Use the **pointer** and the **TouchRing™** to navigate between pages .



# Printing Reports

If you are satisfied with the report preview, you can print a hard copy of the report.

Touch the **Print Report** button on the touch screen to send the report to a configured printer.

If a hard-copy printer is not available, the Report will not be sent.





# 7 Image and Data Management



# Saving Data

## Capturing Images and Clips

You can capture and save a single image, or a clip sequence.

Clips can be captured retrospectively or prospectively.

The captured frame or clip sequence is saved in the patient study, and a thumbnail is available in the live imaging display and the Review display.

During capture, an icon is displayed at the bottom of the display.

When the capture is complete, a thumbnail of the image is displayed.

## Capturing a single Image

1. Press **Freeze**
2. Press **Save Image**

The image appears in the thumbnail strip on the right side of the screen.



## Capturing a Retrospective Clip Sequence

The Aixplorer® allows you to capture retrospective clips.



1. Press **Freeze**.
2. Press **Save Clip** when frozen to save the images in the clip sequence just acquired.  
When the capture is complete an audible beep will confirm that the clip was saved.  
The clip appears in the thumbnail strip on the right side of the screen.

Do not press **Review** until you hear the beep.

## Capturing a Prospective Clip Sequence

The Aixplorer® allows you to capture prospective clips in live imaging.

1. Press **Save Clip** during live imaging initiates a prospective clip capture.

Prospective clip capture will automatically complete after the duration specified in the System Configuration.

When capture is complete an audible beep will confirm that the clip was saved.

2. Press **Save Clip** again or **Freeze** to stop the capture.

Do not change the scaling of the image during the prospective clip capture, especially the following settings:

- **Digital Zoom**
- **Display Format**
- **Dual Top/Bottom**
- **Trapezoidal mode**

On a DICOM review workstation, changing the scaling of the image may result on possible inaccurate measurements performed afterwards on DICOM prospective clips.

3. The clip appears in the thumbnail strip on the right side of the screen.

Do not press **Review** until you hear the beep.



## NOTE

Pressing **Save Image** while acquiring a prospective clip does not stop the prospective clip acquisition.

## Setting up the duration of a prospective clip capture

See [Chapter 8, Customizing the System \[337\]](#).

To set up the duration of a prospective clip capture:

Choose the desired duration of prospective clip captures from the available options:

2 sec, 5 sec, 10 sec, 15 sec, 30 sec, 1, 2, 3, 4, 5 min

Note: a specific duration may be set for contrast mode.

## Trimming Clips

Trim allows you to discard frames from the start or end of a prospective or retrospective clip.

1. Press **Trim** on the touch screen.

The trackball is arbitrated to **Trim End**.

2. Move the **Trackball** towards the beginning of the clip to discard the required frames from the end of the clip

The trackball is arbitrated to **Trim Start**

3. Move the **Trackball** towards the end of the clip to discard the required frames from the start of the clip
4. Turn **Trim** off to cut the trimmed frames out.
5. Press **Save Clip** to save a new clip without the trimmed out frames.

If needed, press **Trim Reset** to return the Trim Start and Trim End frames to the start and end of the acquisition, respectively.

## Reviewing an Exam

During or after an exam, use Review to examine and compare images acquired in the exam. Multiple exams for one patient may be reviewed. In Review, you can look at the images or clip sequences that have been stored.

Stored images can be viewed, sent, printed, searched and backed up.

Image analysis can also be performed in Review.

Images that are stored on the ultrasound system hard-drive can be sent to a DVD, USB media, or on DICOM-compatible devices on a network.

## General Information on Review

In Review mode, a variety of tasks may be completed, including performing measurements and playing clip sequences.

### MEASUREMENTS IN REVIEW

In Review mode, measurements on images in the current exam can be performed.

An image must first be displayed in full size.

Measurements made in Review on the current exam can be saved in the report.

Measurements made in Review on prior exams cannot be saved.

To display the measurement controls on the Review Exam touch screen, press **Meas**. Clear all measurements from an image by touching **Erase all** on the Review Exam touch screen.



## Starting Review

Press **Review** to enter Review mode.

The display that appears depends on whether an exam is active on the system.

If an exam is in progress, pressing **Review** opens the Review Exam display.

If there is not an exam currently in progress when **Review** is selected, the Patient Directory will be displayed.

If an automatic deletion is set up in the system configuration, you can lock some exams to prevent them from being automatically deleted.

To return to live imaging, press **Review** again.

## Patient Directory

The Patient Directory is a list of exams that are stored on the selected disk drive.

The Patient Directory includes options that allow the user to sort, view, and transfer exams.

If no current exam is in progress when Review is started, Patient Directory is displayed.

### ABOUT PATIENT DIRECTORY HEADERS

In the Patient Directory, exams are organized in a table containing several columns.

Each column header describes the contents of that column using either text or an icon.

Click on a column header to sort the list by this column.

The Exam Status column displays the number of times an exam has been continued (if any).



## Selecting and Loading Exams



If an exam is currently in progress, pressing Review opens the Review Exam display with images loaded from the current exam.

If no exam is in progress, pressing **Review** opens the Patient Directory display, which lists previous exams.

To review previous exams, first select an exam in the Patient Directory. Multiple exams of the same patient may be selected and loaded for review.

To select all exams click **Select All**

Click **Display Selected** to load the selected exams for viewing

## VIEWING IMAGES

The Review Exam display is used for viewing and comparing exam images in the selected layout.

Thumbnail images for the current or selected exam appear on the right side of the display.

The touch screen display provides access to other review functions.

## NAVIGATING THUMBNAILS OF IMAGES

In Review small images, called thumbnails, can be viewed.

Thumbnails are located on the right side of the Review Exam display.



Touch **Previous thumbnail** and **Next thumbnail** on the Touch Screen to navigate through thumbnails of images. This will display the previous or the next image in full screen review mode.

Putting the pointer over a thumbnail makes it expand to a larger dimension.

Clicking on the thumbnail image will make it expand to its real size.

Clicking on the garbage icon over a thumbnail deletes that image.

## COMPARING IMAGES

In Review, two images from different exams of the same patient may be compared.



1. Select the two exams in the Patient Directory
2. Click **Display Selected**.
3. Click on the patient name on the left side  
Thumbnails of the two exams will appear.
4. Select the two images to be reviewed and touch **Compare**.  
The two images appear side by side. They can be reviewed at the same time and measurements and annotations can be performed.

## Printing Images

For environmental purposes, print only when necessary.

Use digital devices for storage.

You can print to an integrated printer (option) or to printers on a network.

The system allows you to configure print controls and printers.

## Printing in Live Imaging

You can print live or frozen images during an exam.

1. Acquire the desired image
2. Press **Save Image** on the control panel

Images will be printed according to the printers that are associated and configured (see [Chapter 8, Customizing the System \[337\]](#)).



## PRINTING STORED IMAGES TO A LOCAL PRINTER

From the review exam display, you can print stored single and multi frame images, one at a time, from 1 to 15 images per page.

1. Press **Review**
2. Select an exam
3. Press **Display Selected**
4. In the Review Exam display, select images you want to print
5. Select which printer to use with the appropriate knob on the touch screen
6. Select the desired layout with the next knob
7. Touch **Print**.

**Important:** In order to configure the network, you must connect the network cable at the back of Aixplorer® to a local area network first.



## PRINTING STORED IMAGES TO A DICOM PRINTER (OPTIONAL)

In the Review Exam display, you can send single-frame images from the system to DICOM-printers.



1. Press **Review**
2. Select an exam
3. Touch **Display Selected**
4. In the Review Exam display, select one or more images
5. Touch **Export to DICOM**
6. In the Send To dialog box, select a DICOM printer
7. Click **OK** to print the selected images



### **NOTE**

You can configure the same printer to both automatic printing and manual printing. See [the section called “Media Settings” \[346\]](#).

# Sending a Study

## Export Formats

In Review, specific images can be pushed to DICOM printers (optional) and servers on a network, to a CD/DVD, or to a USB device.



### NOTE

The format can be chosen before sending images or clips.

To send an enlarged image to a printer or USB device, see [Chapter 8, Customizing the System \[337\]](#).

## Sending Images

In the Review Exam display, images can be pushed from the system to DICOM compatible printers and servers on a network. Also, images can be sent to the DVD drive on the system.

1. In the Review Exam display, select one or more images
2. Touch **Export to DICOM** or **Export as JPEG/H264**
3. In the Send To dialog box, select a destination

In the Send To dialog box, the total space, as well as the free space available on the device are displayed for a USB device.



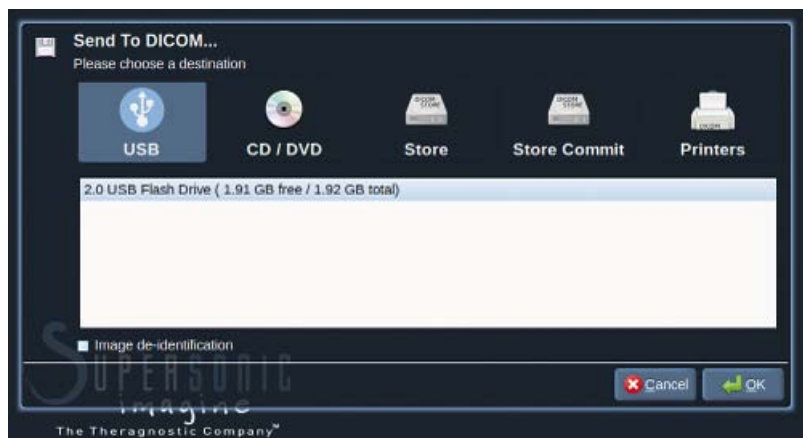

## NOTE

Check the Image de-identification checkbox in the Send To dialog box to send the image(s) with identification fields cleared from the database and the image.

4. Click **OK** to send the selected images  
The exams will be exported into folders organized by patient name.



To eject a CD/DVD:

1. Click on the appropriate icon (CD or DVD)
2. Follow the instructions that appear on the screen

If you need to manually eject the CD/DVD, insert a paper clip in the hole located right next to the CD/DVD player.



To eject a USB device:

1. Wait until the  symbol (exporting data to USB) is replaced by  in the notification icons area
2. Remove the USB device



## WARNING

Ensure that both the user and the patient do not place hands or any other body parts on or in the USB port

At anytime, you can check the export status, by clicking on the appropriate notification icon on the left side of the screen.

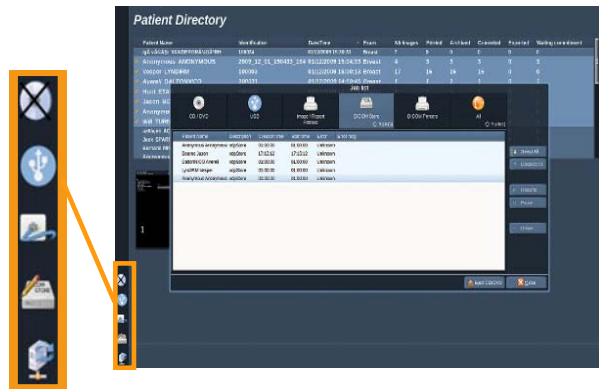

For information on icons, refer to [the section called “Notification Icons” \[152\]](#).

## Clinical Data Export (optional)

With the Aixplorer®, you have the capability to manage your own clinical trials by exporting data in 2 different formats.

The **User's Club** format allows you to export anonymized images and measurements together in order to post them in your clinical study (User's Club tool).



The **Excel** format allows you to export un-anonymized measurements in order to utilize the data in a spreadsheet.

To export data:

1. Plug a USB device
2. Press **Review** to access the Patient Directory
3. Select the exam(s) you want to export
4. Touch **Clinical Data Export** on the touch screen
5. Select an export format
6. Select your device
7. Press **Start**

The systems exports your data in the selected format on your USB device.

For more information on the User's Club: [www.aixplorerclub.com](http://www.aixplorerclub.com)  
[<http://www.aixplorerclub.com>]





# DICOM Structured Reporting (DICOM SR)

The DICOM Structured Report is a document architecture designed for encoding and exchanging clinical information and findings in the context of Radiology imaging.

The DICOM SR is supported for OB-GYN clinical application on the Aixplorer® and uses the NEMA's Template ID 5000 OB-GYN Ultrasound Procedure Report.

One image/clip acquired within the OB-GYN clinical application will trigger the creation of a DICOM SR report.

## CONFIGURATION

### DICOM Store

1. In the System Configuration, click on the **Devices** sub-tab of the Administration tab
2. Click on the **Advanced options** of your DICOM store device
3. Click on **Edit Selected**
4. Select the **Enable Export of SR** checkbox

### DICOM Removeable media

1. In the System Configuration, click on the **Devices** sub-tab of the Administration tab
2. Click on the **DICOM Removeable media**
3. Click on **Edit Selected**
4. Select the **Enable Export of SR** checkbox

## SENDING METHODS

### Automatic Send of DICOM SR Reports

When the export of SR is enabled for one or several DICOM Store devices, a DICOM SR file will be sent automatically at the end of the exam to this/these configured DICOM Store devices.

### Send On Demand of DICOM SR Reports

During a live examination, and if the export of SR is enabled for one or several DICOM Store devices, you may send on demand updated versions of the DICOM SR report to this/these configured DICOM Store devices.

1. Press **Review** or **Report** on the control panel
2. Press **Send SR** on the touch screen

### Manual Send of DICOM SR Reports

1. When an exam is ended, click on **Review**
2. Select the exam for which you want to send the SR, and press **Display Selected**
3. In the Review Image List, click on the **DICOM SR icon**
4. Press **Export to DICOM** on the touch screen
5. Select the device and click on **OK**

# Deleting exams and images

The Patient Directory allows you to delete exams from the system.

If an exam is accidentally deleted, and the exam has been archived to a DVD, the archived exam can be re-loaded.

In the Review Exam display, stored images from an exam can be deleted.

This is only possible, however, when Send Images/Clips in Print/Network setups is set to At End of Exam.

When an image is deleted, it remains temporarily in the Review Exam display with an X marked through it.

## To delete one or more images

1. Select the images to be deleted
2. Touch **Delete Selected** on the touch screen
3. Click on **Delete** in the confirmation box

## To delete exams

1. In the Patient Directory, select one or more exams. To select all exams, touch **Select All**
2. Click **Delete Selected**
3. Click on **Delete** in the confirmation box

# Image Query and Retrieve

Prior to, or during an exam, a query may be performed to find patient exams located on a remote workstation.

Qualified images can be extracted from these exams and retrieved by the Aixplorer®.

Once retrieved, the images can be browsed, and an appropriate image can be selected for Review.

A retrieved image may also be displayed in a side-by-side manner next to a live image in the current exam.

**Important:** The Query and Retrieve feature requires the Aixplorer® system is connected to a network hosting a DICOM compliant image archive workstation.

## General Information about Query-Retrieve

If there is no current exam, a query may be performed for any number of studies from the workstation.

These studies can be retrieved by the Aixplorer® in preparation for upcoming new exams.

If there is a current exam in progress, the query will attempt to find prior exams of the current patient (if the automatic Q/R was configured).

Valid types to be retrieved are as follows:

- DICOM Ultrasound images
- DICOM Ultrasound images extracted from ultrasound clips
- DICOM images from a variety of modalities: computed radiography (CR), computed tomography (CT), magnetic resonance (MR), nuclear medicine (NM), secondary capture (SC), x-ray angiographic (XA), x-ray rf (RF), digital mammography x-ray (MG)

Please consult your workstation user's manual, the workstation DICOM conformance statement or your workstation/PACS administrator for assistance with secondary captures.

Any retrieved exam can be displayed along with a live image in a current exam.

However, if there are mismatches in patient identification characteristics between the current exam and the retrieved exam, a warning will be displayed.



## FOR MORE INFORMATION ON DICOM

For more information on DICOM, have a look at our DICOM Conformance Statement and IHE Statement on our website:

<http://www.supersonicimagine.com/dicom>

<http://www.supersonicimagine.com/ihe>

Refer to **the section called “Notification Icons” [152]** for Query-Retrieve notification icon.



## WARNING

Displaying a patient with a different patient identification to that in the current exam must be done with caution.

This feature is provided in the event of a patient name change, or hospital ID change.

The operator assumes all risk when performing query retrieve operations on Aixplorer®.

Retrieved images can be very helpful when used for reference comparison to the same feature of interest in the live ultrasound image.

Use caution when reviewing retrieved images on Aixplorer®, as they may be compressed or displayed at a lower level of image quality than observed on the PACS workstation.

Images retrieved and displayed on the Aixplorer® are not intended to be used for sole diagnosis.

# Performing a Query

## Automatic Query



If configured, the system can perform an automatic query of various types of exams for a given patient.

When the exam is started for a given patient, press **Save Image** to save a first image for this patient.

The system automatically performs a query on the selected patient.

Press the **Q/R** button on the control panel to view the queried exams.

See [Chapter 8, Customizing the System \[337\]](#) for more details.

## Manual Query

Press the **Q/R** button to initiate an exam query.

The query dialog box will appear.



Click on the tab on which you want to query:

- Patient Name (Name)
- Patient ID (ID)
- Accession Number (Accession)

Use the appropriate filters to manage the query.

When you are ready press **Query**.

A list of matching exams will be displayed.

# Performing a Retrieve

## Automatic Retrieve

If configured, the system performs an automatic retrieve of the last acquired series for each of the selected modalities.

## Manual Retrieve

After a query is performed, the system will return a list of matching exams.



The screenshot shows a window titled "Queried Exams" with a table of exam data. The table has columns for Name, ID, Date of Birth, Modality, #, and DateTime. The data is as follows:

Name	ID	Date of Birth	Modality	#	DateTime
Robin DESBOIS	100017	02/12/1948	US		23/08/2010 12:28:22
Robin DESBOIS	100017	02/12/1948	US		09/08/2010 12:03:04
✓ Robin DESBOIS	100017	02/12/1948	US		05/08/2010 10:23:32
✓ Robin DESBOIS	100017	02/12/1948	US	7	05/08/2010 10:23:32
Robin DESBOIS	100017	02/12/1948	US	1	05/08/2010 10:23:32
Robin DESBOIS	100017	02/12/1948	US	1	05/08/2010 10:23:32
Robin DESBOIS	100017	02/12/1948	US		28/07/2010 14:43:39
Robin DESBOIS	100017	02/12/1948	US		15/07/2010 08:46:34
Robin DESBOIS	100017	02/12/1948	US		08/07/2010 17:11:19
Robin DESBOIS	100017	02/12/1948	US		07/07/2010 14:59:06
Robin DESBOIS	100017	02/12/1948	US		06/07/2010 09:09:20
Robin DESBOIS	100017	02/12/1948	US		05/07/2010 12:34:47

At the bottom of the window, there are buttons for "Show all", "Select All", "Unselect All", "Delete", "New Query", and "Retrieve".

Exams are displayed in a table with the following attributes:

- Patient Name
- Patient ID
- Date of Birth
- Modality
- Number of Images
- Date/Time

To see more information about a particular study, place the pointer over a study and a tool-tip box will appear with additional information.

Use **Select** to choose exams from the query list.



A checkmark will appear next to selected exams.

If you would like to query again, choose the **New Query** button at the bottom of the menu.

Press the **Retrieve** button to retrieve the selected exams.

These exams will be transferred to the Aixplorer® system.



## NOTE

Exams containing large numbers of images or long ultrasound loops may take a long time. It is best to perform a query and retrieve operation prior to the start of an exam.

When the selected exams have been retrieved, **RETRIEVED** appears next to each line.

## Displaying and Navigating Retrieved Images

Double-press **Select** on an image to display it in full screen.



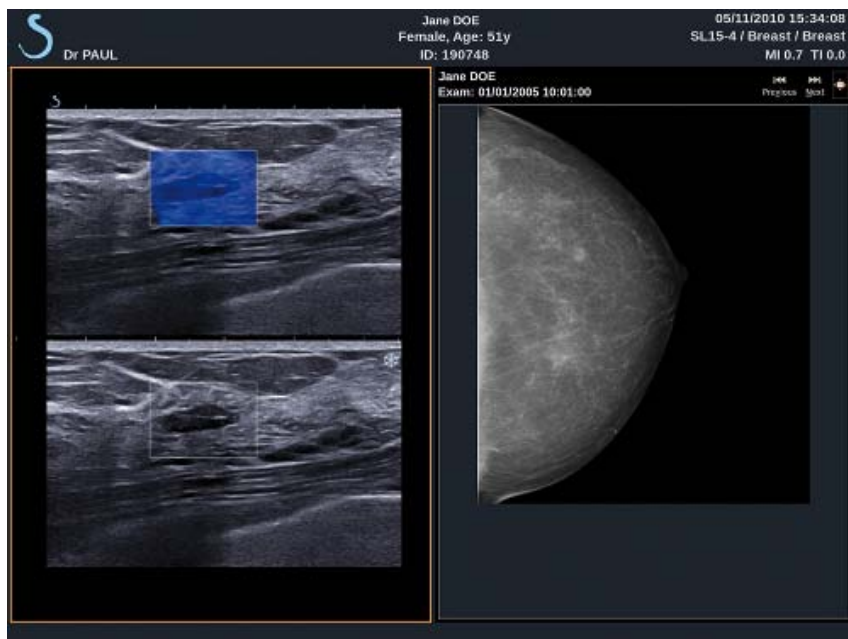

The retrieve image will be displayed in the right pane.

You can navigate through the retrieved images by using the buttons at the top of the pane:

- **Previous** will go to the previous image
- **Next** will advance to the next image.

You can also use the **TouchRing** to navigate through the retrieved images.

The **full screen icon** will enlarge the retrieved image to the side of the full screen, temporarily hiding the live or frozen image from the current exam.

All system controls will operate as usual on the current live or frozen image.

System controls will not effect the retrieved image.

## Exiting Query and Retrieve

To quit viewing retrieved images, press the **Q/R** button on the control panel.



## Ending an Exam

Make sure all the images you need are saved.  
After the exam is complete, end the exam as follows:  
Press **End Exam** on the control panel.



## Continuing an Exam

You have the possibility to continue an exam that was ended.

1. Press **End Exam** to make sure there is no exam in progress
2. Press **Review**
3. From the Patient Directory, select the exam you want to continue
4. Press **Continue** on the touch screen

The system has re-opened the closed exam and is in B-mode. The thumbnails of the previous session(s) of the same exam are displayed on the right side.

The time limit to re-open an exam may be configured in the **System/Display** tab of the System Configuration.

Press **End Exam** to close the exam.





# 8 Customizing the System



# Description of the System Configuration



Your system can be customized in several ways to make it more useful for your needs.

Presets designed specifically for the exams you perform can be created, and system settings can be changed to optimize your workflow.

System configuration allows you to configure the entire system, its applications, and additional options.



To access system configuration, touch **Syst.Config.** on the touch screen while in any active imaging mode.

Any changes made to the system configuration are automatically saved, unless otherwise specified.

Touch **Exit** on the touch screen to exit system configuration.

The system configuration is divided in 7 tabs:

- System/Display
- Device Settings
- Administration
- Presets
- Measurements
- Research (optional)
- System Diagnostics

Refer to each section for detailed information.

# System/Display

## Description of the System/Display Tab

The System/Display tab is divided in 3 tabs:

- System
- Regional parameters
- Exam

## System

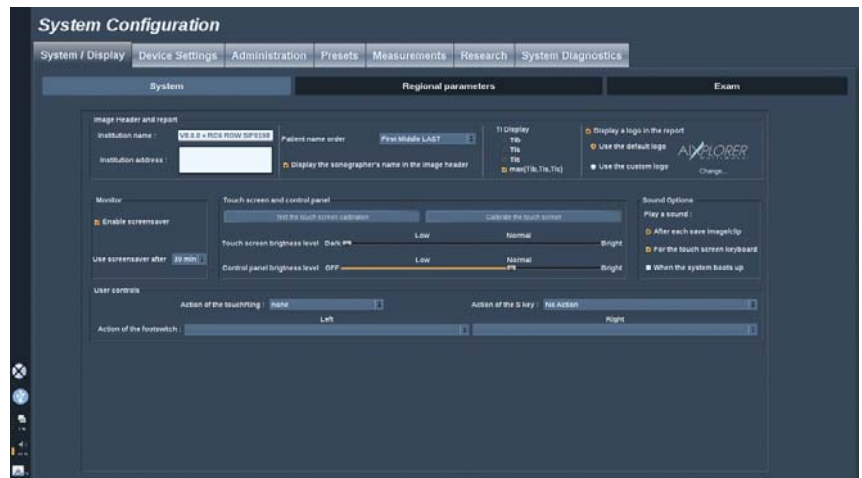

In this section, you can :

- Enter the institution name and address
- Choose the patient name order
- Display/not display the sonographer's name in the image header
- Select the Thermal Index (TI) to display on the imaging screen
- Upload from a usb media and insert a logo which will be displayed on the report header or choose the default logo to be displayed on the report header





## NOTE

To change the logo to be displayed in the printed report:

1. Make sure the «Display logo in report» checkbox is checked
  2. Do one of the following:
    - Select «Use the default logo» if you want to use the Aixplorer® logo
    - Select «Use the custom logo» if you want to use your own logo
      - Then plug a USB device with the logo you want to use into the system
      - Then click on the logo to browse for your own logo
- Enable/disable the screen saver, and configure it
  - Calibrate the touch screen



## NOTE

To calibrate the touch screen:

1. Press “touch screen calibration - calibrate now”
  2. Press each calibration point that appears on the touch screen until it disappears
- Set the illumination intensity of the control panel
  - Activate a sound while for the following functions:
    - After each Save Image/Clip
    - For the touch screen Keyboard
    - When the system boots up
  - Set the function assigned to the TouchRing™ while in B mode
  - Assign a function to the programmable key (‘S’ Button on the control panel)
  - Assign a function to each side of the foot switch (available as an option)

## Regional parameters

This section refers to the regional settings and language configuration of the system.

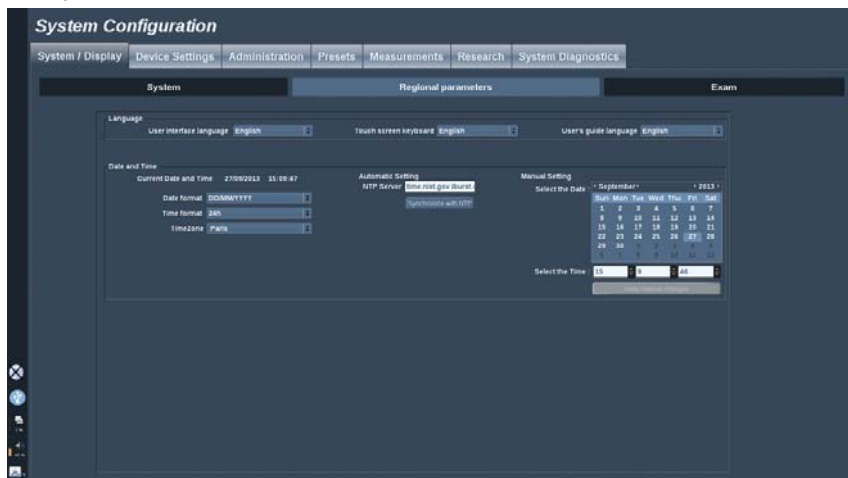

In this section, you can:

- change the system interface language
- set the keyboard language
- choose the user's guide language for the **Help** button
- change the date and time format
- adjust the system's date and time.



### NOTE

To set date and time:

1. Select a time zone from the drop down list
2. Do one of the following:
  - Enter a Network Time Protocol (NTP) server (by default, you can enter ntp.ubuntu.com), and click on “Synchronize with NTP” in the Automatic setting box
  - Pick a date and set the time in the Manual setting box, then click on “Apply manual changes”



# Exam

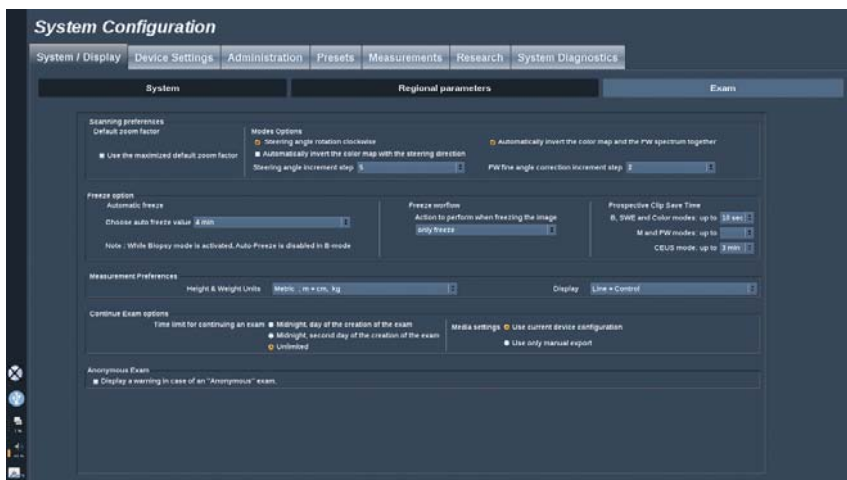

In this section, you can:

- Customize your scanning preferences:
- Choose to use a maximized zoom factor by default



## NOTE

If you change this option during an exam, you will have to re-select your preset to apply the change.

- Adjust some preferences for the Color and PW modes
  - Auto-Invert Color/PW links the color map to the PW spectrum. Select this option to invert the color map automatically when you invert the PW spectrum
  - Steering Angle Step defines the incremental step for the steering of the color box
  - PW Fine Angle Step defines the incremental step for the Fine Angle Correction in PW
  - Choose to automatically invert the color flow map when the steering angle is negative
  - Customize the knob rotation direction for the steering angle
- Customize some Freeze options:
  - Set time for the live mode's auto freeze

- Choose the action to perform after freezing the image:
  - only freeze
  - display body markers
  - display annotations
  - display measurements
- Configure the limit duration of the prospective clip capture, for contrast mode and for the other modes.
- Customize the way the measurements are displayed
- Customize the Continue exam mode (see [the section called “Continuing an Exam” \[335\]](#))
- Choose to have a warning popup when saving an image for an anonymous patient

# Device Settings

## Description of the Device Settings Tab

The Device Settings tab is divided in 3 tabs:

- Media settings
- Media association
- System DICOM options

## Media Settings

In this section, you can configure all the media already added and associated.

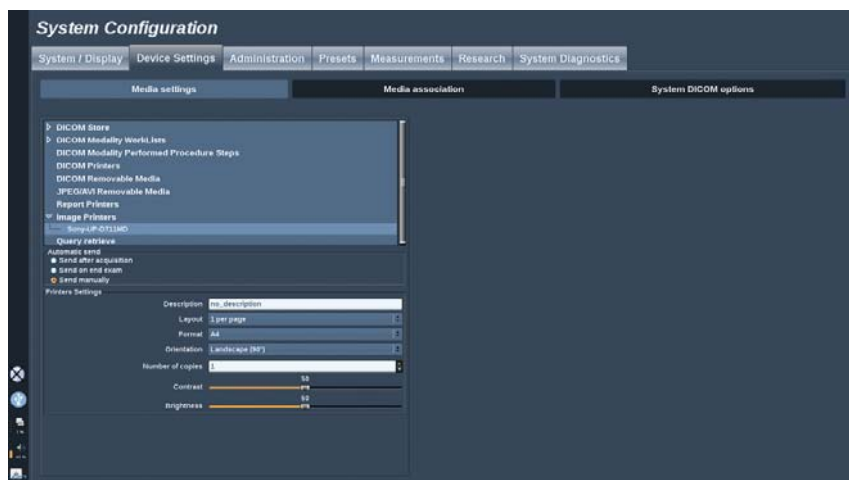

Click on Media Settings to see the list of active devices.

For each one, if available, a menu allows you to define the method to send the data :

- Send after acquisition
- Send on end exam

- Send manually



## **NOTE**

You can associate twice the same printer in order to configure one printer for automatic print (after acquisition or on end exam) and the other one for manual printing.

You can also define printing or DICOM image parameters, printing layouts, image compression levels, ...

You can export or print enlarged images. This feature is only available for single image display.

To do so, check the appropriate checkbox.



## **NOTE**

For more information on DICOM, have a look at our DICOM Conformance Statement on our website:

<http://www.supersonicimagine.com/dicom>

# Media Association

In this section, you can associate any media added in the tab Administration.

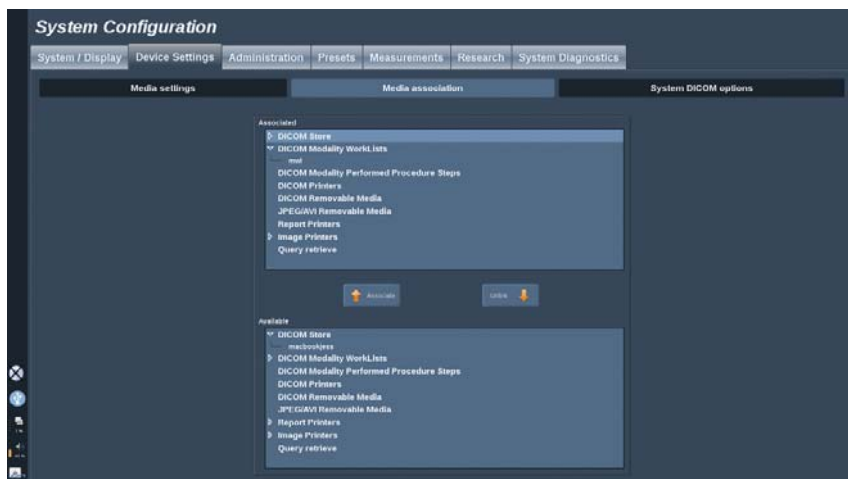

This section allows you to add an active device to the working configuration.

You can choose from the device list which has been pre-configured in the Administration part of the System Configuration.

To associate a device:

1. Navigate to the bottom of the screen where you will find the “available devices” list.
2. Click on the type of device, a list will be displayed.
3. Select the specific device you would like to associate.
4. Click on “associate”. The device will appear at the top of the screen in the “associated devices” list.



## NOTE

You can remove a device from the associate list by selecting it and click on the ‘unlink’ button.



# System DICOM options

In this section, you can adjust the DICOM parameters.

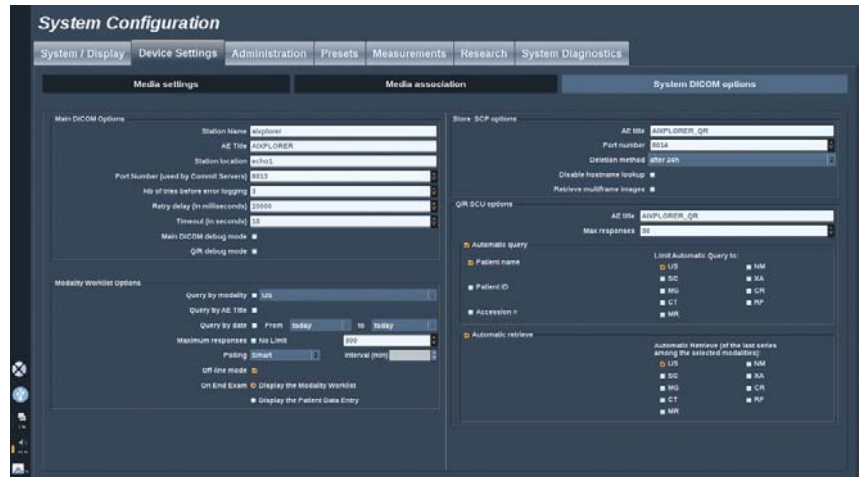

In the Main DICOM Options part, you can enter all the DICOM parameters that identify the ultrasound system on a DICOM network.

In the Modality Worklist Options part, you can set the way of querying the Modality Worklist SCP and automatic refresh time of the worklist when this device is available and configured in the Administration part.

You can also configure the way the Modality Worklist is refreshed with the “polling option”:

- Choose “Manual” to refresh the Worklist only manually
- Choose “Automatic” to set up a time to automatically refresh the Worklist
- Choose “Smart” to automatically refresh the Worklist each time you press End Exam on the control panel.

You can also choose to use the Off-line mode, so that when the network is disconnected, you still have access to the last refresh of the Worklist.

You can also set your workflow preference for the end of the exam:

- Display the Modality Worklist
- Display the Patient Data Entry

In the Store SCP Options part, you can enter all the DICOM parameters that identify the Store SCP and the automatic deletion method.

In the Q/R SCU options part, you can configure the Query/Retrieve parameters.

You can also configure the automatic query and automatic retrieve by selecting the queried fields and modalities.



# Administration

## Description of the Administration Tab

The Administration tab is divided in 5 tabs:

- Devices
- Network configuration
- Network tools
- Disk maintenance
- Medical Staff



### **CAUTION**

Image compression may result in the loss of image information.

While low levels of image compression are generally acceptable in medical imaging, using high levels of lossy compression may result in image degradation.

It is the responsibility of the user to set and maintain the degree of image compression which is diagnostically acceptable in exported images.

If you are uncertain as to what degree of compression is acceptable, consult the literature, or use the system default compression.

# Devices

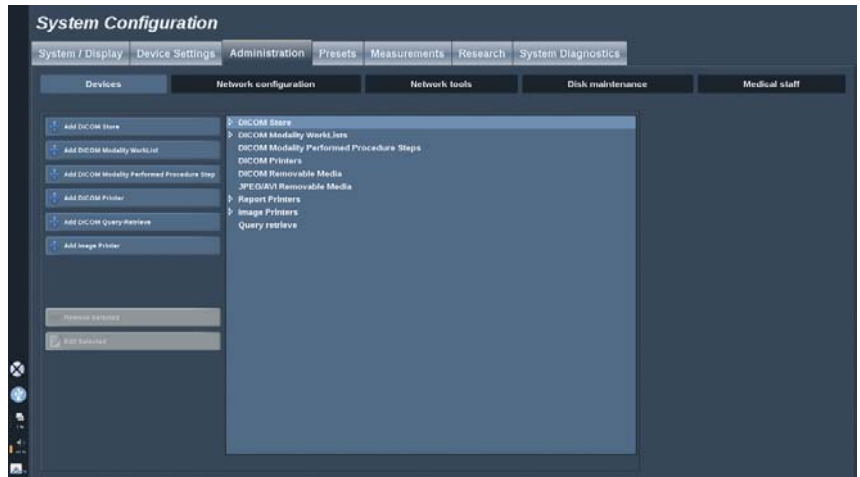

Devices refers to the initial devices configuration.

A list of device types that can be added is displayed on the right side of the screen, according to the options purchased:

- Add DICOM Store<sup>1</sup>
- Add DICOM Modality Worklist<sup>1</sup>
- Add DICOM Modality Performed Procedure Step (MPPS)<sup>1</sup>
- Add DICOM Printer<sup>1</sup>
- Add DICOM Query/Retrieve<sup>1</sup>
- Add image Printer

Click on the appropriate button on the left to add a device and configure its parameters.

Click on a device in the middle of the screen to view and configure its parameters.

<sup>1</sup>Available only if the DICOM option has been purchased

# Network Configuration

This section concerns the network configuration of Aixplorer®.

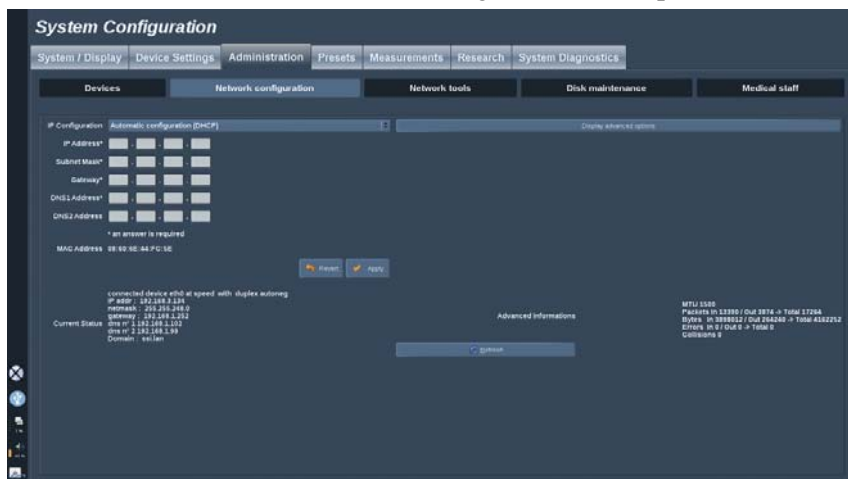

The system can be configured with a specific IP address and network setting, with a cable connected or can be automatically configured in DHCP mode.

For any network configuration, the MAC address is displayed and once connected, the network status is also displayed (especially important for the DHCP configuration).

## Network Tools

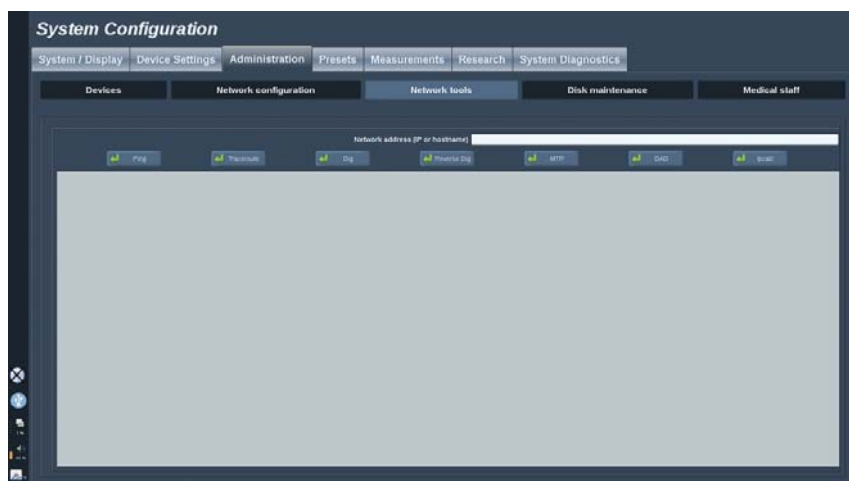

Once you have configured the network (see [the section called “Network Configuration” \[354\]](#)), you have access to network tools:

- Ping
- Traceroute
- Dig and Reverse Dig
- MTR
- Duplicate address detection DAD
- IPcalc

Contact your local SuperSonic Imagine Service Representative for further instructions on the use of these tools.

# Disk Maintenance

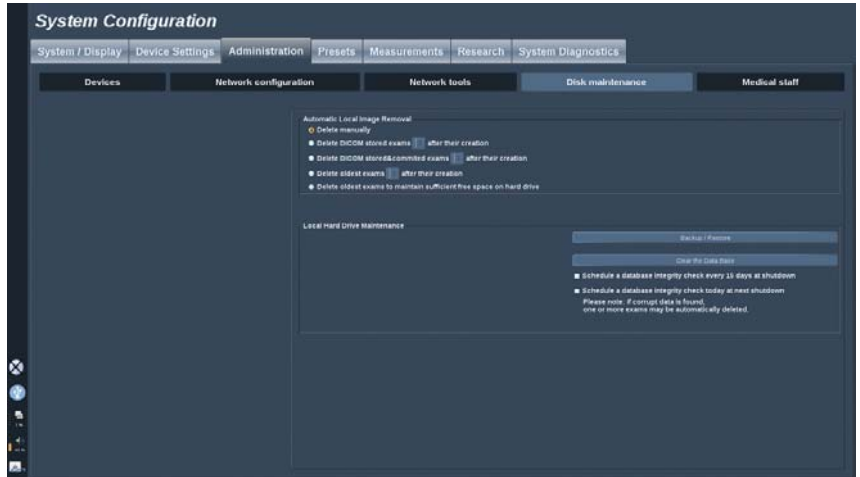

This section concerns all of the options to manage the studies contained on the system hard drive.

## Back up/Restore

You can also back up and restore some elements from your system.

### BACK UP

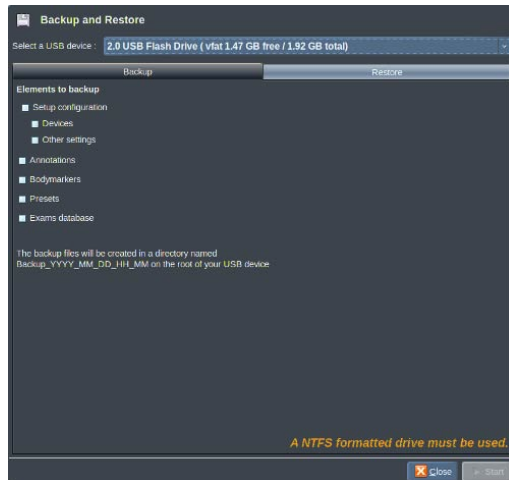



1. Plug a USB device on which you want to back up some elements from your system
2. Press the **Backup/Restore** button
3. Enter the password
4. Press **OK**
5. Select your USB device
6. Select the elements you want to back up
7. Press **Start**

## RESTORE

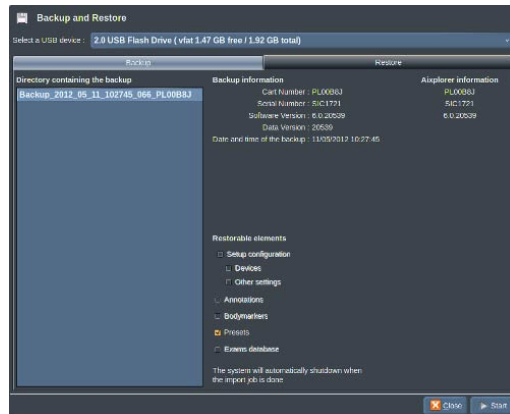

1. Plug the USB device on which you backed up some elements of your system
2. Press the **Backup/Restore** button
3. Enter the password
4. Press **OK**
5. Select the USB device on which you backed up some elements of your system
6. Select the **Restore** tab
7. Select the back up file you want to restore on the left
8. Select the elements you want to restore on the right
9. Press **Start**

# Medical Staff

**System Configuration**

System / Display | Device Settings | Administration | Presets | Measurements | Research | System Diagnostics

Devices | Network configuration | Network tools | Disk maintenance | **Medical staff**

Last Name: \_\_\_\_\_  
First Name: \_\_\_\_\_  
Middle Name: \_\_\_\_\_  
Abbreviation: \_\_\_\_\_  
Name prefix: \_\_\_\_\_ Name suffix: \_\_\_\_\_

DICOM ID Sequence Code value: \_\_\_\_\_  
Coding scheme designer: \_\_\_\_\_  
Coding scheme version: \_\_\_\_\_  
Code meaning: \_\_\_\_\_

Name shall appear under:  Performing physician / sonographer  Referring physician  Requesting physician  
\*Last Name or First Name is required  
\*Abbreviation of the performing physician / sonographer will be displayed during the exam and on the report

Name	Abbreviation
JANE DOE	JD
JOHN SMITH	JS
BERNIE BOODIE	BS
JOHN DUFF	JD
MIKE SINGER	MS
BO BERTON	BB
COBY COBE	CC
EARL GRAY	EG
ANNE ROE	AR

This section allows you to manage the list of physicians and sonographers that you can choose from in the Patient Data Entry.

In the list at the bottom of the screen, click on a name to display the related information in the appropriate fields above the list.

To add a name:

1. Click on **New** on the right side of the list
2. Enter the appropriate data

The new name is automatically saved. They can be selected from the Patient Data form.

# Presets

A Preset is a group of settings that optimizes the system for a specific type of exam. Presets establish many initial settings, such as gain value, color map, filter, TissueTuner™, Flow Optimizations, etc... When the system is turned on, the default Preset is active. Before beginning an exam, be sure that the appropriate Preset is active. You can choose from several default Presets. These default Presets cannot be deleted. Several Presets per transducer/application combination can be created and stored, depending on the number of buttons available on the individual transducer touch screen.

## Description of the Presets Tab

The Presets tab is divided in 3 tabs:

- Annotations
- Bodymarkers
- Presets

It allows you to customize annotations and bodymarker packages, as well as imaging presets.



want to remove from its group. The annotation button becomes “transparent” (no color) and will not be replaced by another one

8. To move an annotation from one group to another, click on the new group color you want to apply, and click on the annotation. The annotation will change color
9. To change a rotary knob label or create a new one, click on the **Edit Title** button located next to the knob you want to edit, and change it in the pop-up window
10. To delete a rotary knob value, click on the value and then click on the **-** button next to it
11. To add a rotary knob value, type the new value in the box and click on the **+ Add to the list** button next to it
12. To move a rotary knob value within the list, click on it and then click on the arrows next to it

# Bodymarker

This section allows you to edit the body marker libraries and to customize some options related to body markers.



## Options

You can choose to remove the body marker every time you unfreeze the image by checking the “Remove body marker on unfreeze” option.

You can choose to remove the probe marker from the body marker every time you unfreeze the image by checking the “Remove probe marker on unfreeze” option.

You can set up a time out for the body marker touch screen. At the end of this time out, the body marker touch screen will be automatically closed.

## Body Marker Library

In this section, you can customize the body marker library for each preset.

## TO VIEW THE BODY MARKER LIBRARY AVAILABLE FOR A GIVEN PRESET

1. Select the package you want to modify on the right part

You can navigate through the different pages of the library by using the following buttons:

- **First** displays the first page of the library
- **Previous** displays the previous page of the library
- **Next** displays the next page of the library
- **Last** displays the last page of the library

You can add and remove pages for the selected library by using the **Add** and **Remove** buttons.

## TO REMOVE A BODY MARKER FROM THE PACKAGE

1. Click on the body marker you want to remove
2. Click on the **Remove** button below the arrow

## TO MOVE A BODY MARKER ON THE PACKAGE PAGE

1. Click on the body marker you want to move
2. Click on the appropriate **arrow**

## TO SET A GIVEN BODY MARKER AS DEFAULT FOR THE PACKAGE

1. Click on the body marker you want to set as the default body marker for the library
2. Click on **Set as default** below the arrows

The selected body marker will be displayed by default every time you press Body Marker on the control panel for the selected preset.

## TO ADD A BODY MARKER TO A PACKAGE

All the available libraries on the system are displayed on the left part.

1. Select the appropriate package

The available body markers are displayed below.

2. Click on the body marker you want to add to your library
3. Click on the **Add** button

The selected body marker will be added at the first available space in your library.

Note: all changes are automatically saved.

You can reset a body marker library for a given preset as it was by default by clicking on **Reset to default**.

## TO CREATE A NEW BODY MARKER PACKAGE

1. Click on **New** and enter the name of the package in the pop-up window.
2. Choose bodymarkers in the library and add them to your package. Refer to [the section called “To add a body marker to a package” \[364\]](#)

## TO DUPLICATE A PACKAGE

1. Click on **Duplicate** and enter a new name in the pop-up window.

A new package will be created with all the bodymarkers from the initial package without modifying it.

To add a bodymarker from another package, select the appropriate package and proceed as for adding a bodymarker.



# Imaging Presets

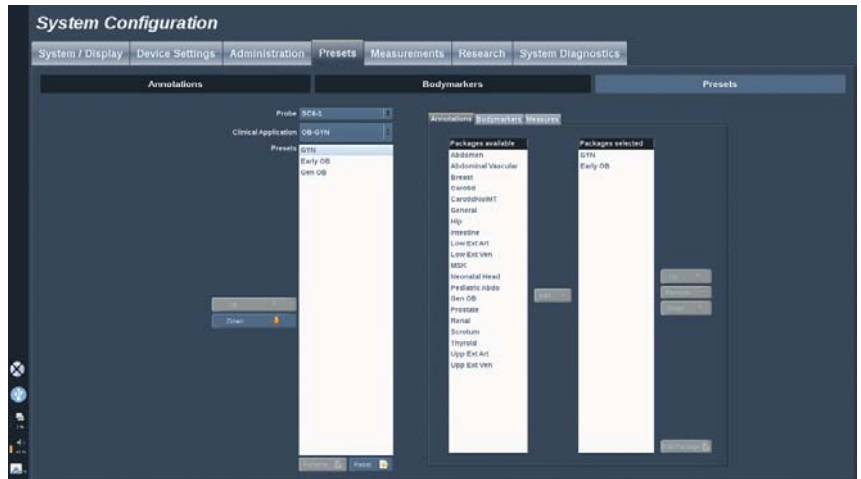

## Creating a Preset

Once you have set the system to a desired configuration, you may want to make a Preset.



1. Press **Probe** on the control panel
2. Touch **New Preset**

A dialog box will appear on the main display.

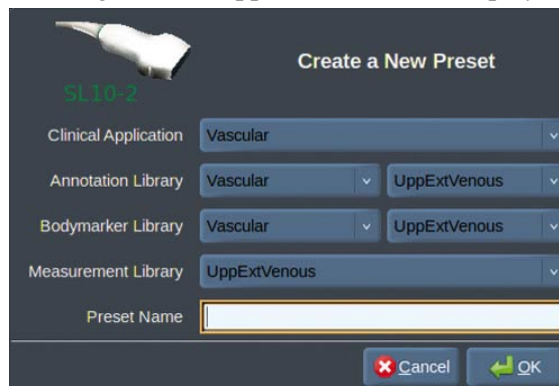

3. Select the application in which you want to save the preset
4. Select an annotation library for your new preset
5. Select a body marker library for your new preset
6. Select a measurement library for your new preset
7. Using the keyboard, enter a name for your new Preset.
8. Select **OK**.
9. Press **Probe** on the control panel to verify your Preset.

The user-created presets appear in light blue on the touch screen.  
The factory presets appear in dark blue on the touch screen.

## Managing Presets

In the Presets sub-tab, you can manage imaging presets.

1. Select the appropriate probe and application on the left side of the screen.

The available presets for this probe and this application will appear.

2. Select the preset that you want to modify.
3. You can move a preset within the list with the **Up** and **Down** buttons.

They will be displayed in the same order on the touch screen preset page.

4. To reset a factory preset to the default configuration, click on **Reset**.

## CHANGING THE DISPLAY ORDER OF THE PRESETS ON THE TOUCH SCREEN

1. Select the appropriate probe and application on the left side of the screen.

The available presets for this probe and this application will appear.

2. Select the preset that you want to modify.
3. You can move a preset within the list with the **Up** and **Down** buttons.

They will be displayed in the same order on the touch screen preset page.

4. To reset a factory preset to the default configuration, click on **Reset**.

## MODIFYING THE ANNOTATION PACKAGE(S) OF A PRESET

1. Select the small **annotation** tab on the right side of the screen.

You will see the available packages box on the left of the Add button and the selected packages box on the right.

The selected packages are those already available in the preset.

2. To add an annotation package, select the appropriate package in the available packages box and click on **Add**.

It will appear in the selected packages box.

3. In the selected packages box you can remove a package by clicking on **Remove**.
4. You can also move a package within the list using the **Up** and **Down** buttons.
5. To edit the annotation package, select a package in the selected packages box and click on **Edit Package**.

## MODIFYING THE BODY MARKER PACKAGE(S) OF A PRESET

1. Select the small **bodymarker** tab on the right side of the screen.

You will see the available packages box on the left of the Add button and the selected packages box on the right.

The selected packages are those already available in the preset.

2. To add a bodymarker package, select the appropriate package in the available packages box and click on **Add**.

It will appear in the selected packages box.

3. In the selected packages box you can remove a package by clicking on **Remove**.
4. You can also move a package within the list using the **Up** and **Down** buttons.

- To edit the bodymarker package, select a package in the selected packages box and click on **Edit Package**.

## MODIFYING THE MEASUREMENT PACKAGE(S) OF A PRESET

- Select the small **measurement** tab on the right side of the screen.

You will see the available packages box on the left of the Add button and the selected packages box on the right.

The selected packages are those already available in the preset.

- To add a measurement package, select the appropriate package in the available packages box and click on **Add**.

It will appear in the selected packages box.

- In the selected packages box you can remove a package by clicking on **Remove**.
- You can also move a package within the list using the **Up** and **Down** buttons.
- To edit the measurement package, select a package in the selected packages box and click on **Edit Package**.

## Changing a Preset Name



- Do one of the following:
  - Press **Probe** on the control panel, then touch **Manage Presets** on the touch screen
  - Touch **Syst. Config.** on the touch screen, then click on **Presets** and **Presets**
- Choose the probe and the application  
The list of user-defined Presets appears.
- Click on the Preset you want to rename and click on **Rename**  
A popup menu appears
- Enter a new name
- Click on **OK** to validate

## Deleting a Preset

You can delete the Presets you created. The factory presets cannot be deleted.

1. Do one of the following:
  - Press **Probe** on the control panel, then touch **Manage Presets** on the touch screen
  - Touch **Syst. Config.** on the touch screen, then click on **Presets** and **Presets**
2. Choose the probe and the application  
  
The list of user-defined Presets appears.
3. Click on the Preset you want to delete and click on **Remove**.  
  
A popup menu appears.
4. Click on **OK** to validate

# Measurements

## Description of the Measurements Tab

The Measures tab is divided in 4 tabs:

- Measures
- Labels and Calculations
- Packages
- Obstetrics

## Measures

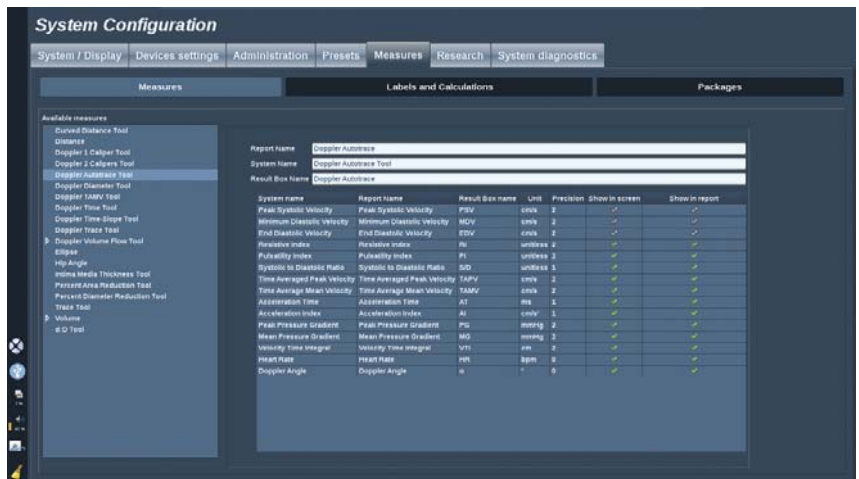

This section allows you to customize the measurement tools.

1. Select a measurement in the left list
2. You can modify the unit and the precision. Click on the unit or the precision you want to modify and select the appropriate unit in the drop down list.
3. Check the measurements that you want to be displayed on screen and/or included in the report.

# Labels and Calculations

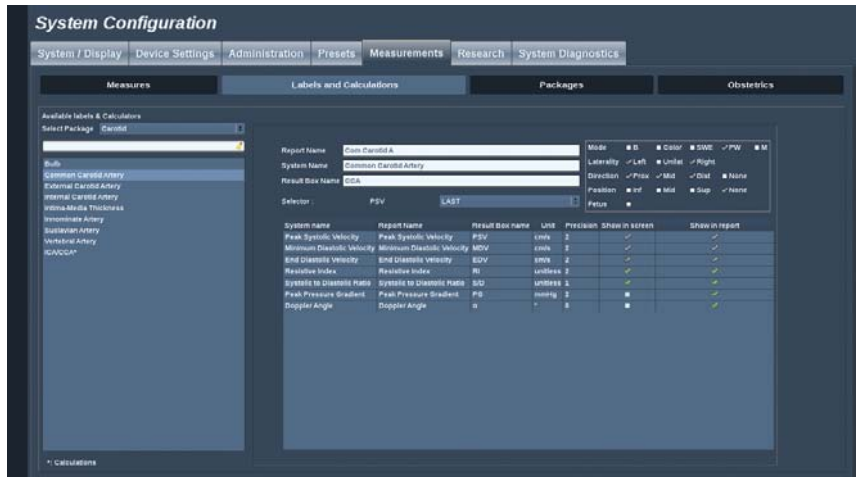

This section allows you to configure each labeled measurement individually.

1. Select the appropriate package
2. Select the labeled measurement you want to customize



## NOTE

You may use the white area as a search box to easily find a labeled measurement in the list.

Click on the broom icon to erase the text in the search box.

The information and options related to this labeled measurement appear on the right.

3. You can modify the unit and the precision. Click on the unit or the precision you want to modify and select the appropriate unit in the drop down list.
4. Check the measurements that you want to be displayed on screen and/or included in the report.

# Packages

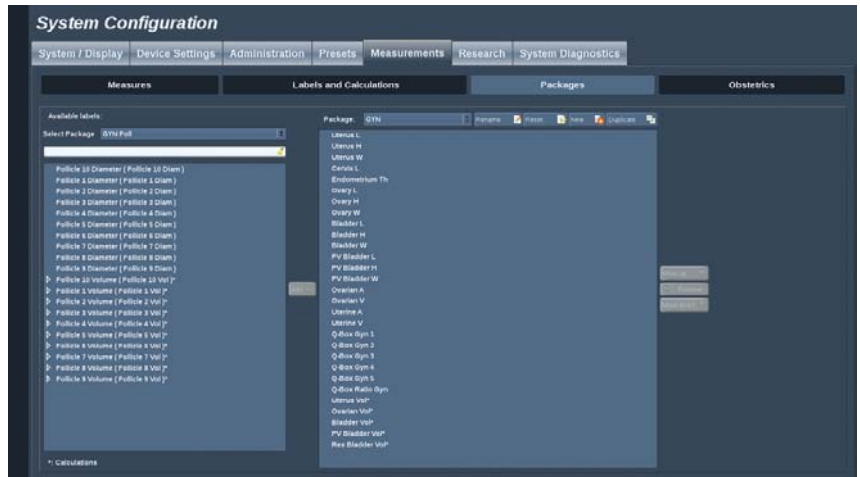

This section allows you to configure your own labeled measurements packages.

The left side box contains all the labels available on the system.

The right side box contains the labels available for the selected application, as it appears on the main display when you press **Meas.** on the control panel.

You can edit the labels that are available for a given application.

## To add a labeled measurement to a package:

1. Select the package you want to modify on the right side of the screen
2. Select the package that contains your labeled measurement on the left side of the screen. You can select All to see the labeled measurements available on the system.
3. Select the labeled measurement you want to add from the left side list
4. Click on **Add**

## To remove a labeled measurement from a package:

1. Select the package on the right side of the screen



2. Select the labeled measurement you want to delete from the right side list
3. Click on **Remove**

**To move a labeled measurement within the list in a package:**

1. Select the package
2. Select the labeled measurement you want to move from the right side list
3. Click on **Move up** or **Move down** until it reaches the desired place

**To rename a package:**

1. Select the package on the right side of the screen
2. Click on **Rename**
3. Enter a new name in the pop-up window

**To reset a package to its default configuration:**

1. Select the package on the right side of the screen
2. Click on **Reset**

**To create a new package:**

1. Click on **New**
2. Enter a name in the pop-up window and click on OK
3. You can then add labeled measurements to the new package. It will be available in the presets.

**To duplicate a package:**

1. Click on **Duplicate**
2. Enter a name in the pop-up window and click on OK

A new package will be created with all the labeled measurements.

# Obstetrics

The Obstetrics section is divided in 2 parts:

- GA - EFW (Gestational Age - Estimated Fetal Weight)
- Tables and Equations

## GA - EFW

(Gestational Age - Estimated Fetal Weight)

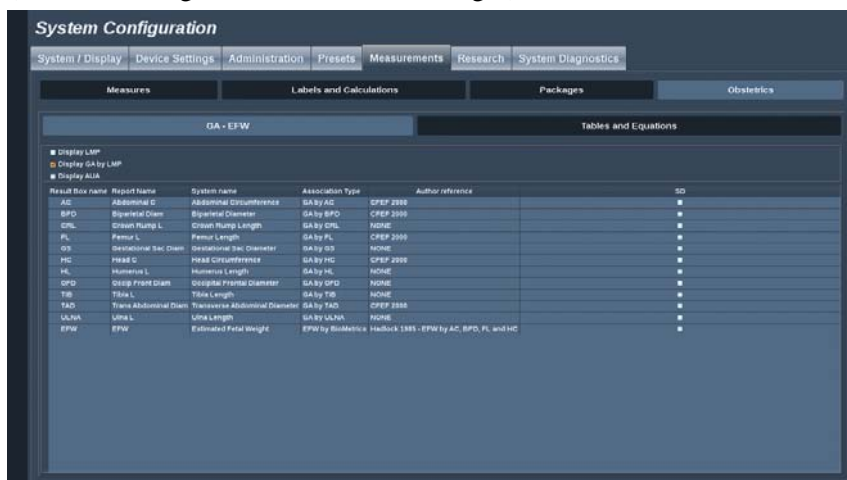

This section allows you to customize the information you want to display on screen:

- LMP
- GA by LMP
- AUA

In this section, you can also specify the table you want to use for each OB calculation.

For each OB calculation (whose name is displayed in the **Result Box name column**), the type of calculation is described in the **Association Type** column.

1. Click on the **Author reference** name to select another author.

# Tables and Equations

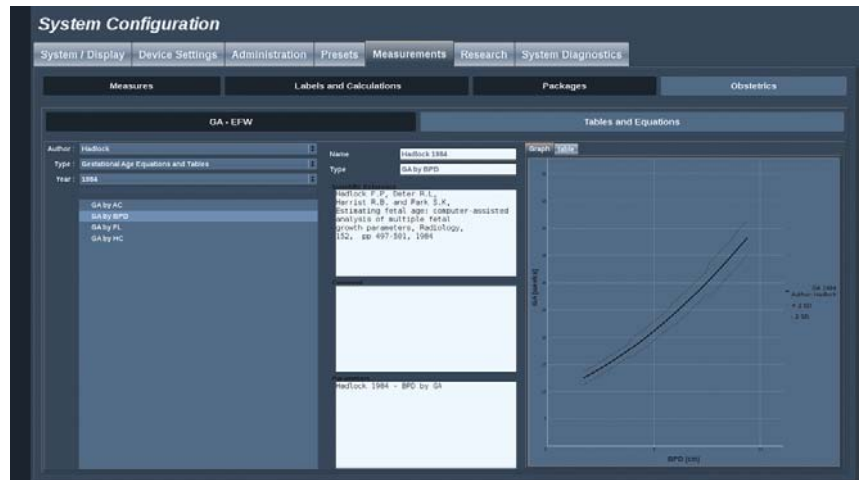

In this section, you can visualize the reference tables for OB as tables or graphs.

1. Select the Author, Type and Year of publication
2. In the right part, click on Graph to visualize the graph or Table to visualize the table.

# System Diagnostics

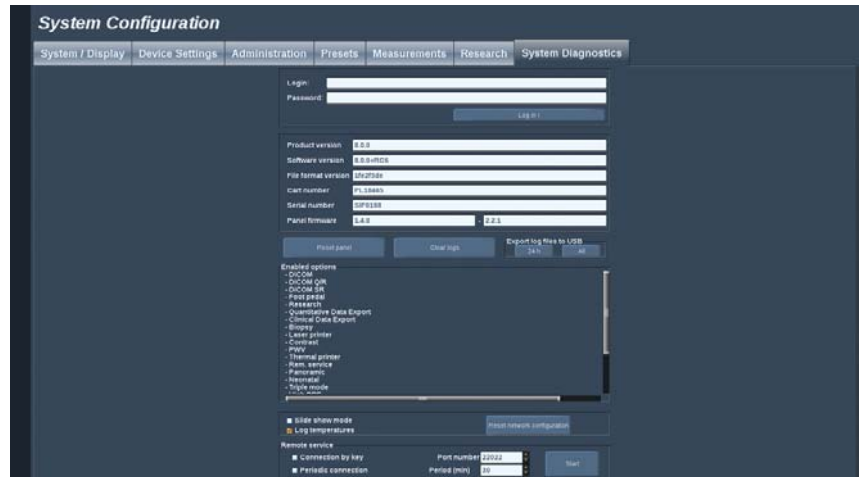

The Diagnostic tab is intended to be accessed by service personnel only.

Password access to the some of the contents is required to perform system diagnostic tests.

This section is only for field service engineers.

A password is not required to access some basic system information, as follows:

- Product version
- Software version
- File format version
- Cart number
- Serial number
- Panel firmware
- List of enabled options

In addition, 3 buttons are available:

- Reset Panel
- Clear logs
- Export logs to USB

In this tab you also have access to the remote service.

# 9 System Care & Maintenance



# Changing Printer Paper and Toner







Refer to the user's manual of your specific printer for guidance on how to properly change printer paper and toner.

## Cleaning the System

### Cleaning Frequency

You can perform the maintenance operations as described in this chapter. Cleaning of the Aixplorer® ultrasound system should occur at regular intervals, or more frequently as needed.

SuperSonic Imagine provides the following recommended cleaning intervals as guidelines:

	<b>Part</b>	<b>Recommended Cleaning Frequency</b>
	System Display Monitor	Weekly, or as needed
	System Control Panel	Daily, or between patients
	Touchscreen Display	Daily, or between patients
	System Exterior: chassis and Handles	Weekly, or as needed
	Air Filters	Inspect weekly; clean monthly; replace annually
	Transducers: cleaning and disinfection	Between patients

It is prudent to continually survey the system for maintenance needs. Contact your SuperSonic Imagine Sales or Service authorized representative for further details.



## **CAUTION**

If you have any questions regarding basic maintenance, or prefer to have maintenance service performed, contact your authorized SuperSonic Imagine Service representative.

Always press the On/Off switch, turn off the power switch at the back of the machine, and disconnect the system from the wall outlet before performing maintenance or cleaning the system.

It is recommended that gloves and protective eyewear are used when cleaning the system.

Do not spray any cleaning agents directly onto the system. They may leak into the system, damaging the system and voiding the warranty.

Do not allow standing liquid to collect around the control panel keys.

Do not allow liquid to drip inside the system chassis.



## Cleaning the Exterior of the Machine

The exterior of the system should be periodically cleaned with a soft cloth, lightly moistened with water and a gentle soap. This includes the system chassis, control panel and handles. Be sure to clean any unused gel from the surface of the control panel after system use.

The products below have been tested and found to be compatible with SuperSonic Imagine Aixplorer®.

Solution	Manufacturer	Cleaner/ Disinfectant	Active ingredient
Sani-Cloth Active	PDI	<b>Disinfectant</b>	Quat. Ammonia

## Cleaning the Monitor

A clean, soft cotton cloth dampened with an ammonia-based window cleaner should be used to clean the Monitor display. Do not use paper towels, as these may scratch the display monitor. The cleaning agent should be sprayed onto the cloth, not directly onto the display surface. Take care not to get any cleaning agent into the housing of the system. This may lead to system damage.

## Cleaning the Touch Screen Display

A clean, soft cotton cloth dampened with an ammonia-based window cleaner should be used to clean the Touch Screen display. Do not use paper towels, as these may scratch the display monitor. The cleaning agent should be sprayed onto the cloth, not directly onto the display surface. Take care not to get any cleaning agent into the housing of the system. This may lead to system damage.

## Cleaning Air Filters

The Aixplorer® ultrasound system is equipped with air filters. These should be inspected every week and cleaned as needed. At first switch on of the system after the first day of the month, the system displays an icon as a reminder to check the air filters. Please refer to the following air filter cleaning procedure, and click **OK** on the pop-up window.

The air filters are located:

- in a slot at the rear side of the system
- in a slot at the bottom side of the system.

To remove the rear air filter, open the cover on the back. To remove the side air filter, open the left side cover with a pen. It is recommended that air filters be cleaned monthly or more frequently if a significant accumulation of dust or debris is noted.

Air filters may be removed, washed with mild soap and rinsed thoroughly with water. Allow the filters to air dry before re-installing in the system. Spare air filters are provided for immediate use. Additional air filters can be ordered from SuperSonic Imagine Customer Service.





## To Maintain Air Filters

1. Remove the air filter cover by pulling the bottom of the cover towards you.
2. Inspect the filter, and if it is dirty, replace it with a spare
3. Depending on the condition of the air filter, use either a vacuum cleaner or soap and water to clean the dirty filter
4. Thoroughly dry the cleaned filters before re-installing



### **WARNING**

Before performing maintenance or cleaning, always press the On/Off switch, turn off the power switch at the back of the machine, and then disconnect the system from the wall outlet.

Increased internal temperature can be caused by dirty air filters.

Failure to keep the air filters clean can result in the system becoming unavailable during critical use.

Never install an air filter that is not completely dry.



### **CAUTION**

Turn off power before you remove the air filters.

Do not turn power on without air filters installed.

# Cleaning and Disinfecting Transducers

## Transducer Cleaning Safety



### **WARNING**

Use care when handling and cleaning ultrasound transducers.

Do not use a damaged or defective transducer.

Do not immerse or allow liquid to penetrate a transducer which has had its face or cable sheath compromised.

Failure to follow these precautions can result in serious injury and equipment damage.

Follow these precautions to avoid injury and equipment damage:

Inspect the transducer prior to cleaning for damage or degeneration to the lens, housing, cable and connector.

Do not use or apply liquid cleaning agents to a damaged or defective transducer.

Do not immerse the transducer into any liquid beyond the level specified for that transducer.

Never immerse the transducer connector or transducer adapters into any liquid.

Transducer damage can result from contact with inappropriate coupling or cleaning agents.

Use only cleaning agents which have been approved for the specified transducer.

Do not soak, immerse, or maintain prolonged contact with solutions containing alcohol, bleach, ammonium chloride compounds or hydrogen peroxide.

The level of disinfection required for a device is dictated by the type of tissue it will contact during use. ensure the solution strength and duration of contact are appropriate for the intended clinical use of the transducer

Always use protective eyewear and gloves when cleaning, disinfecting or sterilizing any equipment

Be sure to observe the expiration date of the sterilization solution Avoid disinfectant contact with the connector label



## **CAUTION**

Biological hazards may exist if ultrasound transducers are not properly cleaned or disinfected.

This is especially true if the transducer comes in contact with mucous membranes or bodily fluids.

Proper cleaning and disinfection are necessary to prevent disease transmission and infection control.

It is the responsibility of the equipment user to verify and maintain the effectiveness of the infection control procedures in use.

For any procedures where the transducer may come in contact with bodily fluids or mucous membranes, the use of a legally marketed, sterile, pyrogen free transducer sheath is recommended.

Only use disposable sheaths. Sheaths are never to be reused.

Use caution when using disinfectant products.

Wear rubber gloves and protective eyewear.

Always follow the disinfectant manufacturer's instructions.

In order for liquid chemical disinfectants to be effective, all visible residues must be removed during the cleaning process.

For effective cleaning, follow the instructions accompanying the cleaner/disinfectant product.

Care should be taken to avoid applying disinfectant agents to the cable-housing junction.

Do not allow any fluids to enter the cable-housing junction.

Do not use any alcohol or alcohol-based products on the transducer cable.

If the transducer shows signs of damage such as cracks, splitting, delamination of the face or cable damage, discontinue use of the transducer and contact your authorized SuperSonic Imagine Service representative for assistance.

## Transducer Cleaning and Disinfection Guidance

Cleaning and disinfection is a two step process: a cleaning step followed by a disinfection step.

### Cleaning

Cleaning is intended to remove all foreign matter (blood, tissue, protein, scanning gel, etc.) from the device.

### Disinfection

The level of disinfection required for a device is dictated by the type of tissue it will contact during use. There are three classifications: non-critical, semi-critical, and critical. These are based on the degree of risk of infection involved in the use of the device.

Non-critical applications are those where the device contacts only intact skin; semi-critical applications are those where the device contacts mucus membranes or minor skin breach; critical applications are those where the device enters a normally sterile environment, sterile tissue or vasculature.

Ultrasound transducers used for non-critical applications generally need only be cleaned and low-level disinfected between patient uses.

Transducer used in semi-critical application should be cleaned and high level disinfected after use even if a sheath was used.

Transducers used in critical applications should be sterilized and the use of a sterile sheath is recommended. Transducer used in critical application should be cleaned and sterilized after use even if a sheath was used.

## **General Cleaning and Disinfection Procedures for the Aixplorer® Transducers**

The SuperSonic Imagine Aixplorer® transducers are intended for use in non-critical and semi-critical imaging applications. The transducer must be thoroughly cleaned and disinfected after each use. In general, only low-level disinfection is required for non-critical applications of the SuperSonic Imagine Aixplorer® transducer.

For semi-critical applications, high-level disinfection is required and only one of the high level disinfectants chosen from the list below should be used.

High-level disinfection for semi-critical applications is recommended, carefully following the manufacturer's instructions with regard to application and contact time as indicated on the product label.

### **Procedure to Prepare Transducer for Disinfection**

1. After every patient exam, carefully wipe the face and housing of the ultrasound transducer to remove any traces of ultrasound coupling gel.
2. Inspect the transducer for any signs of damage such as cracks, splitting, delamination of the face or cable damage. If any damage is noted, do not proceed with the cleaning or disinfecting procedures and call your authorized SuperSonic Imagine Service representative for assistance.
3. Wipe the transducer face, housing and cable with a water-moistened soft cloth. The use of a mild soap, low-level cleaner or enzymatic cleaner (from the table below) is acceptable.
4. If stubborn material has dried on the face or housing of the transducer, carefully scrub the transducer using water moistened gauze, sponge

or surgeon's soft bristle brush. Wipe away any material with a water-moistened soft cloth.

5. Rinse the transducer thoroughly with water. Do not allow water to access the cable-housing junction.
6. Air dry or dry using a soft dry cloth.

## Disinfection Procedure

1. Always clean the transducer prior to disinfection. (See steps above.)
2. When using an FDA or CE -cleared (as appropriate) disinfecting agent, carefully follow the instructions provided by the manufacturer of the product.
3. For low-level disinfection, the lens and housing of the transducer may be wiped with any of the **cleaners/low level disinfectants** listed in the associated transducer table.
4. For high-level disinfection, the transducer may be wiped or soaked using one of the **disinfectants** listed in the associated transducer table.
5. Air dry or dry using a soft dry cloth.
6. Re-inspect the transducer for any signs of damage such as cracks, splitting, delamination of the face or cable damage before putting the transducer back into use.

## Cleaning and Disinfection Products

### For the SL15-4, SL10-2, SMC12-3 and SC6-1 probes

Solution/system	Manufacturer	Cleaner/Disinfectant	Active ingredient
Alkaspray GSA (Cidalkan)	Alkapharm	<b>Cleaner Disinfectant</b>	Isopropyl alcohol Alkylamine



Solution/system	Manufacturer	Cleaner/ Disinfectant	Active ingredient
Alkazyme	Alkapharm	Cleaner Disinfectant	Quat. Ammonia
Anioxyde 1000	Anios	Disinfectant	Peracetic acid
Cidex OPA*	Advanced Sterilization Products	Disinfectant	Orthophtalaldehyde
Cidezyme	Johnson and Johnson	Cleaner	Proteolytic enzymes
Gigasept FF	Schuller&Mayr	Disinfectant	Succindialdehyde, dimethoxytetrahydrofuran
Linget' Anios	Anios	Cleaner Disinfectant	Ethanol Digluconate de chlorhexidine Alkylaminoalkylglycine
Mikrobac Tissues	Bode	Disinfectant	Benzyl-C12-18-alkyldimethyl-ammonium chlorides didecyldimethylammonium chloride
Sani-Cloth Active	PDI	Disinfectant	Quat. Ammonia
Steranios	Anios	Disinfectant	Glutaraldehyde
T-Spray	Pharmaceutical Innovations Inc.	Disinfectant	Quat. Ammonia
Tristel Duo	Tristel Solutions Limited	Disinfectant	Chlorine dioxide
Tristel Solo	Tristel Solutions Limited	Disinfectant	Hexamethylenebiguanide

\*: DISOPA in Japan

## For the SE12-3 probe

Solution/system	Manufacturer	Cleaner/ Disinfectant	Active ingredient
Anioxyde 1000	Anios	Disinfectant	Peracetic acid

Solution/system	Manufacturer	Cleaner/ Disinfectant	Active ingredient
Cidex OPA*	Advanced Sterilization Products	Disinfectant	Orthophtalaldehyde
Gigasept FF	Schuller&Mayr	Disinfectant	Succindialdehyde, dimethoxytetrahydrofuran
Steranios	Anios	Disinfectant	Glutaraldehyde
Tristel Duo	Tristel Solutions Limited	Disinfectant	Chlorine dioxide

\*: DISOPA in Japan

## For the SLV16-5 probe

Solution/system	Manufacturer	Cleaner/ Disinfectant	Active ingredient
Cidex OPA*	Advanced Sterilization Products	Disinfectant	Orthophtalaldehyde
Cidezyme	Johnson and Johnson	Cleaner	Proteolytic enzymes
Linget' Anios	Anios	Cleaner Disinfectant	Ethanol Diguconate de chlorhexidine Alkylaminoalkylglycine
Mikrobac Tissues	Bode	Disinfectant	Benzyl-C12-18-alkyldimethyl-ammonium chlorides didecyldimethylammonium chloride

\*: DISOPA in Japan

## General Recommendations for all Probes

The above low level and high-level products have been tested and found to be compatible with SuperSonic Imagine Aixplorer® transducers.

Please check whether the recommended products are approved for use in your country. The use of a non-approved cleaner which results in damage to the probe will void the warranty. The use of low-level and high-level disinfectants outside of those on this list is to be done at the user's and patient's own risk.

## Soaking Limits

If soaking a transducer is required, the transducer may only be immersed in liquid to a level of 3cm (1.18in) above the cable-strain relief junction.

Never immerse the cable-housing junction. Do not leave the transducer immersed longer than required for disinfection. See figure below.

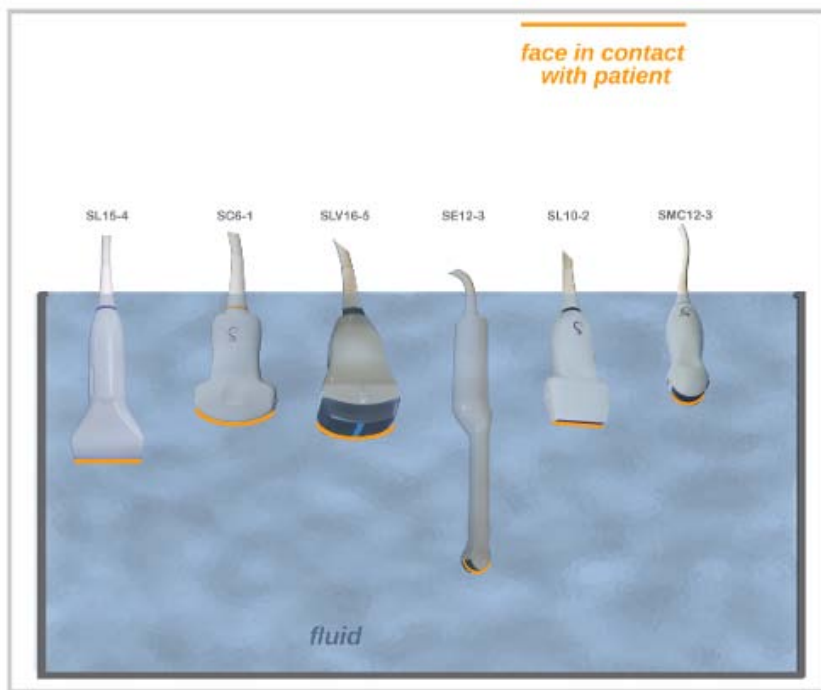

## **Additional Information Regarding Cleaning and Disinfection of Ultrasound Transducers**

Additional information regarding cleaning and disinfection of ultrasound transducers can be found in the following references:

Chemical Sterilization and high-level disinfection in health care facilities. ANSI/AAMI ST58:2005 Sterilization and Disinfection of Medical Devices: General Principles. Centers for Disease Control, Division of Healthcare Quality Promotion.

<http://www.cdc.gov/ncidod/hip/sterile/sterilgp.htm> (5-2003) [[http://www.cdc.gov/ncidod/hip/sterile/sterilgp.htm%20\(5-2003\)](http://www.cdc.gov/ncidod/hip/sterile/sterilgp.htm%20(5-2003))]

ODE Device Evaluation Information—FDA Cleared Sterilants and High Level Disinfectants with General Claims for Processing Reusable Medical and Dental Devices.

<http://www.fda.gov/cdrh/ode/germlab.html>

# 10 Troubleshooting





In all imaging modes and in many data screens, a **Help** button appears on the touch screen.

Press **Help** to open this user's guide directly on the system.

If you encounter difficulty in the operation of the system, use the information in this section to help correct the problem.

If the problem is not covered here, contact your Customer Support Representative.

You may add a description of the problem by clicking on the top left corner of the screen.

The troubleshooting table below contains a list of symptoms and the action to take to correct the problem.

Symptom	Corrective action
System does not power on	Ensure that the system is plugged in to a functioning outlet, and that the circuit breaker on the rear power is set. Turn on power.
Image quality is poor	Take care of ambient light Adjust brightness Adjust contrast Adjust gain, TGC and Auto TGC Adjust position of LCD screen to improve viewing angle
Error message appears on screen	Note the error and contact your customer service representative.
System does not recognize the transducer	Disconnect, reconnect and reselect the transducer. If there is no change, contact your customer service representative.
DVD does not work	Find another DVD disk to store data. If there is no change, contact your customer service representative.
The system does not start, the fans do not spin	Ensure that the system is plugged in to a functioning outlet, and that the circuit breaker on the rear power is set. Turn on power.

Symptom	Corrective action
	If there is no change, contact your customer service representative.
The main monitor does not turn on (fans run and control panel is on)	Check the on/off button on the monitor Check the DVI cable at the back Reboot If there is no change, contact your customer service representative.
The touch screen display is off when the system is ready	Reboot. If no change, contact your customer service representative.
The control panel is off	Reboot. If no change, contact your customer service representative.
The system displays a banner indicating a HW problem	Reboot. If banner stay on, contact your customer service representative.
“GRUB error” is displayed at boot time.	Internal hard drive failure. Service is needed. Contact your customer service representatives
Splash screen is up but the progress bar has not moved for more than 5 minutes	Operating system is damaged. Service is needed. Contact your customer service representative.
A broom icon appears in the icon area of the screen	This icon appears once a month, it is to remind you to check the air filters. Stop the system and verify the filters Click on the icon A pop-up window appears Click yes on the pop-up window The icon disappears
Artefact, white cone(s) in the B-mode, and/or colored cone(s) on the color flow image, starting from the skin line	Reboot the system. If there is no change, contact you customer service representative.



# **11 Acoustic Output Detailed Reporting**



# Table of Symbols used in Acoustic Output Reporting

The following symbols are used in the acoustic reporting tables below:

Symbol	Term
$A_{aprt}$	-12dB output beam area
$d_{eq}$	equivalent beam diameter
$f_{awf}$	acoustic working frequency
$I_{pa,\alpha}$	attenuated pulse-average intensity
$I_{pi}$	pulse-intensity integral
$I_{pi\ \alpha}$	attenuated pulse-intensity integral
$I_{zpta}$	spatial-peak temporal-average intensity
$I_{ta,\alpha}$	attenuated temporal-average intensity
MI	mechanical index
P	output power
$P_{\alpha}$	attenuated output power
$p_{r,\alpha}$	attenuated peak-rarefactional acoustic pressure
$p_r$	peak-rarefactional acoustic pressure
prf	pulse repetition frequency
TI	thermal index
TIB	bone thermal index
TIC	cranial-bone thermal index
TIS	soft-tissue thermal index
$t_d$	pulse duration
$z_b$	depth for bone thermal index
$z_{bp}$	break-point depth
$z_s$	depth for soft-tissue thermal index

# Detailed Acoustic Output Tables

## Acoustic Output Transducer/ Mode Summary Table

The SuperSonic Imagine Aixplorer® system complies with IEC 60601-2-37 standard.

The following table summarizes the transducer/mode combinations for which the global maximum displayed MI or TI is greater than 1.0.

Table 11.1. Transducer/mode combinations for which the global maximum displayed MI or TI is greater than 1.0

Operating Mode	Transducers					
	SL15-4	SC6-1	SE12-3	SLV16-5	SL10-2	SMC12-3
B-mode	☒	☒	☒	☒	☒	☒
Pulsed Doppler	☒	☒	☒	☒	☒	☒
Color Doppler	☒	☒	☒	☒	☒	☒
Amplitude Doppler	☒	☒	☒	☒	☒	☒
Directional Color Doppler	☒	☒	☒	☒	☒	☒
SWE™ Mode	☒	☒	☒	☒	☒	☒
B-Mode + Pulsed Doppler	☒	☒	☒	☒	☒	☒
Harmonic Imaging	☒	☒	☒	☒	☒	☒
CEUS		☒				
B-mode + 3D				☒		
SWE™ + 3D				☒		
M-mode		☒	☒			

## Measurement Uncertainties

Acoustic Quantity	Measurement Uncertainty
Power (P)	+/- 40.2 %
Pressure ( $p_{r,\alpha}$ )	+/- 19.3 %
Intensity ( $I_{pi\alpha}$ at max MI)	+/- 40.2 %
Center frequency ( $f_{awf}$ )	+/- 1 %

These uncertainties are detailed in each acoustic output table below.

## Acoustic Output Detailed Tables

For each transducer/mode combination in the table above which is checked, a detailed acoustic output table has been provided on the following pages.

# SL15-4 Transducer

Operating Mode: 2D echo mode

Index Label			MI	TIS		TIB	TIC	
				Scan	Non-scan			Non-scan
					A<1cm <sup>2</sup>	A>1cm <sup>2</sup>		
Maximum index value			1.6	0.9	-	-	0.75	
Associated acoustic parameters	$p_{r,\alpha}$	(MPa)	3.46					
	P	(mW)		31.46	-		26.63	
	Min. [ $P_{\alpha}(z_s), I_{ta,\alpha}(z_s)$ ]	(mW)				-		
	$z_s$	(cm)				-		
	$z_{bp}$	(cm)				-		
	$z_b$	(cm)					-	
	z at max $I_{pi \alpha}$	(cm)	1.14					
	$d_{eq}(z_b)$	(cm)					-	
	$f_{awf}$	(MHz)	4.875	6	-	-	-	6.63
	Dim of $A_{aprt}$	X(cm)		2	-	-	-	1.24
Y(cm)			0.5	-	-	-	0.5	
Other information	$t_d$	$\mu s$	0.27					
	prr	(Hz)	43					
	$p_r$ at max $I_{pi}$	(MPa)	4.19					
	$d_{eq}$ at max $I_{pi}$	(cm)					-	
	$I_{pi \alpha}$ at max $I_{pi}$	(W/cm <sup>2</sup> )	460					
	Focal length	FL <sub>X</sub> (cm)		1.26	-	-		0.9
FL <sub>Y</sub> (cm)			0.14	-	-		0.12	
Operating control conditions	Focal zone	(mm)	7	68	-	-	-	52
	TX Freq	(MHz)	4.5	6.42	-	-	-	7.5
	Frame rate	(Hz)	40	37	-	-	-	46
	Operating voltage	(V)	55	62	-	-	-	72
	Presets		SupMSK	D.Breast Intestine				

## Operating Mode: Color Doppler

Index Label			MI	TIS		TIB	TIC	
				Scan	Non-scan			Non-scan
					A<1cm <sup>2</sup>	A>1cm <sup>2</sup>		
Maximum index value			1.3	2.36	-	-	-	1.48
Associated acoustic parameters	$p_{r,\alpha}$	(MPa)	3.52					
	P	(mW)		66.54	-		-	61.71
	Min. [ $P_{\alpha}(z_s), I_{ta,\alpha}(z_s)$ ]	(mW)				-		
	$z_s$	(cm)				-		
	$z_{bp}$	(cm)				-		
	$z_b$	(cm)					-	
	z at max $I_{pi} \alpha$	(cm)	1.6					
	$d_{eq}(z_b)$	(cm)						-
	$f_{awf}$	(MHz)	7.38	8.75	-	-	-	8.75
	Dim of $A_{aprt}$	X(cm)		2.26	-	-	-	2.26
Y(cm)			0.5	-	-	-	0.5	
Other information	$t_d$	$\mu s$	0.48					
	prr	(Hz)	259					
	$p_r$ at max $I_{pi}$	(MPa)	5.12					
	$d_{eq}$ at max $I_{pi}$	(cm)						-
	$I_{pi} \alpha$ at max $I_{pi}$	(W/cm <sup>2</sup> )	26					
	Focal length	FL <sub>X</sub> (cm)		0.88	-	-		0.88
FL <sub>Y</sub> (cm)			0.12	-	-		0.12	
Operating control conditions	Focal zone	(mm)	22	68	-	-	-	68
	TX Freq	(MHz)	7.5	9	-	-	-	9
	Frame rate	(Hz)	259	211	-	-	-	211
	Operating voltage	(V)	50	50	-	-	-	50
	Presets		General Breast, SupBreast,	General, Breast, D.Breast, Carotid,				

TIS: 1.46 from CD - 0.9 from 2Decho



TIC: 0.73 from CD - 0.75 from 2Decho

W0(mW) for TIS: 35.08 mW from CD - 31.46 mW from 2Decho

W0(mW) for TIC: 35.08 mW from CD - 26.63 mW from 2Decho

## Operating Mode: SWE

Index Label		MI	TIS			TIB	TIC	
			Scan	Non-scan		Non-scan		
				A<1cm <sup>2</sup>	A>1cm <sup>2</sup>			
Maximum index value		1.7	-	5.6*		5.6*	5.6*	
Associated acoustic parameters	$p_{r,\alpha}$	(MPa)	4.05					
	P	(mW)		-	405.5		405.5	400.7
	Min.[ $P_{\alpha}(z_s), I_{ta,\alpha}(z_s)$ ]	(mW)						
	$z_s$	(cm)						
	$z_{bp}$	(cm)						
	$z_b$	(cm)					1.43	
	z at max $I_{pi}$ $\alpha$	(cm)	1.92					
	$d_{eq}(z_b)$	(cm)					0.82	
	$f_{awf}$	(MHz)	6	-	5		5	5
	Dim of $A_{aprt}$	X(cm)		-	0.48		0.48	0.48
Y(cm)			-	0.5		0.5	0.5	
Other information	$t_d$	$\mu s$	401.18					
	prr	(Hz)	2					
	$p_r$ at max $I_{pi}$	(MPa)	5.42					
	$d_{eq}$ at max $I_{pi}$	(cm)					16.51	
	$I_{pi}$ $\alpha$ at max $I_{pi}$	(W/cm <sup>2</sup> )	452					
	Focal length	FL <sub>X</sub> (cm)		-	6.25		6.25	6.25
		FL <sub>Y</sub> (cm)		-	0.31		0.31	0.31
Operating control conditions	Focal zone	(mm)	16	-	18		18	18
	TX Freq	(MHz)	6	-	5		5	5
	Frame rate	(Hz)	2	-	2		2	2
	Operating voltage	(V)	50	-	50		50	50
	Presets			-	MSK			

TIS: 2.21 from Push - 0.9 from 2Decho - 2.51 from Flat

TIB: 2.55 from Push - 0.9 from 2Decho - 2.51 from Flat

TIC: 4.54 from Push - 0.75 from 2Decho - 1.12 from Flat

W0(mW) for TIS: 303.74 mW from Push - 31.46 mW from 2Decho - 70.34 mW from Flat

W0(mW) for TIB: 303.74 mW from Push - 31.46 mW from 2Decho - 70.34 mW from Flat

W0(mW) for TIC: 303.74 mW from Push - 26.63 mW from 2Decho - 70.34 mW from Flat

\* Sum of TI from worst case of each composing mode is higher than 5.6, however, the system controls the voltage in order to limit the TI to 5.6

## Operating Mode: PW Doppler

Index Label		MI	TIS			TIB	TIC	
			Scan	Non-scan		Non-scan		
				A<1cm <sup>2</sup>	A>1cm <sup>2</sup>			
Maximum index value		1.1	-	0.87		2.44	1.53	
Associated acoustic parameters	$p_{r,\alpha}$	(MPa)	2.54					
	P	(mW)		-	34.15		32.69	16.97
	Min. [ $P_{\alpha}(z_s), I_{ta,\alpha}(z_s)$ ]	(mW)						
	$z_s$	(cm)						
	$z_{bp}$	(cm)						
	$z_b$	(cm)					1.35	
	z at max $I_{pi}$ $\alpha$	(cm)	1.47					
	$d_{eq}(z_b)$	(cm)					0.18	
	$f_{awf}$	(MHz)	5.25	-	5.38		5.25	5
	Dim of $A_{aprt}$	X(cm)		-	0.84		0.84	0.12
Y(cm)			-	0.5		0.5	0.5	
Other information	$t_d$	$\mu s$	0.27					
	prf	(Hz)	10390					
	$p_r$ at max $I_{pi}$	(MPa)	3.19					
	$d_{eq}$ at max $I_{pi}$	(cm)					0.25	
	$I_{pi}$ $\alpha$ at max $I_{pi}$	(W/cm <sup>2</sup> )274						
	Focal length	FL <sub>X</sub> (cm)		-	0.4		0.3	0.81
FL <sub>Y</sub> (cm)			-	0.16		0.16	0.18	
Operating control conditions	Focal zone	(mm)	52	-	68		52	7
	TX Freq	(MHz)	5	-	5		5	5
	Frame rate	(Hz)	10390	-	14286		17568	17568
	Operating voltage	(V)	42	-	50		50	48
	Presets		General Breast,					

# SC6-1 Transducer

Operating Mode: 2D echo mode

Index Label			MI	TIS		TIB	TIC	
				Scan	Non-scan			Non-scan
					$\Delta < 1\text{cm}^2$	$\Delta > 1\text{cm}^2$		
Maximum index value			1.5	0.78	-	-	(b)	
Associated acoustic parameters	$p_{r,\alpha}$	(MPa)	2.79					
	P	(mW)		62.03	-	-	#	
	Min. $[P_{\alpha}(z_s), I_{ta,\alpha}(z_s)]$	(mW)			-	-		
	$z_s$	(cm)			-	-		
	$z_{bp}$	(cm)			-	-		
	$z_b$	(cm)				-		
	z at max $I_{pi \alpha}$	(cm)	1.57					
	$d_{eq}(z_b)$	(cm)					-	
	$f_{awf}$	(MHz)	3.5	2.63	-	-	-	#
	Dim of $A_{aprt}$	X(cm)		3.63	-	-	-	#
Y(cm)			1.3	-	-	-	#	
Other information	$t_d$	$\mu\text{s}$	0.39					
	prr	(Hz)	43					
	$p_r$ at max $I_{pi}$	(MPa)	3.17					
	$d_{eq}$ at max $I_{pi}$	(cm)					-	
	$I_{pi \alpha}$ at max $I_{pi}$	(W/cm <sup>2</sup> )	415					
	Focal length	FL <sub>X</sub> (cm)		1.52	-	-		#
FL <sub>Y</sub> (cm)			0.56	-	-		#	
Operating control conditions	Focal zone	(mm)	18	180	-	-	-	#
	TX Freq	(MHz)	3.33	2.81	-	-	-	#
	Frame rate	(Hz)	43	36	-	-	-	#
	Operating voltage	(V)	70	72	-	-	-	#
	Presets		Prostate, Thyroid,			-	-	-

(b) This probe is not intended for transcranial or neonatal cephalic uses

## Operating Mode: Color Doppler

Index Label		MI	TIS				TIB	TIC
			Scan	Non-scan		Non-scan		
				A<1cm <sup>2</sup>	A>1cm <sup>2</sup>			
Maximum index value		1.3	2.86	-	-	-	(b)	
Associated acoustic parameters	$p_{r,\alpha}$	(MPa)	2.37					
	P	(mW)		244.3	-	-	-	#
	Min. [ $P_{\alpha}(z_s), I_{ta,\alpha}(z_s)$ ]	(mW)				-		
	$z_s$	(cm)				-		
	$z_{bp}$	(cm)				-		
	$z_b$	(cm)					-	
	z at max $I_{pi \alpha}$	(cm)	1.23					
	$d_{eq}(z_b)$	(cm)					-	
	$f_{awf}$	(MHz)	3.06	2.44	-	-	-	#
	Dim of $A_{aprt}$	X(cm)		5.97	-	-	-	#
Y(cm)			1.3	-	-	-	#	
Other information	$t_d$	$\mu s$	0.64					
	prf	(Hz)	43					
	$p_r$ at max $I_{pi}$	(MPa)	2.62					
	$d_{eq}$ at max $I_{pi}$	(cm)					-	
	$I_{pi \alpha}$ at max $I_{pi}$	(W/cm <sup>2</sup> )	153					
	Focal length	FL <sub>X</sub> (cm)		2.44	-	-	-	#
FL <sub>Y</sub> (cm)			0.56	-	-	-	#	
Operating control conditions	Focal zone	(mm)	18	180	-	-	-	#
	TX Freq	(MHz)	3	2.5	-	-	-	#
	Frame rate	(Hz)	74	77	-	-	-	#
	Operating voltage	(V)	63	63	-	-	-	#
	Presets	Abdominal Muscular Vascular				-	-	#

(b) This probe is not intended for transcranial or neonatal cephalic uses

## Operating Mode: SWE Doppler

Index Label		MI	TIS			TIB	TIC	
			Scan	Non-scan		Non-scan		
				A<1cm <sup>2</sup>	A>1cm <sup>2</sup>			
Maximum index value		1.5	-		3.29	4.07	(b)	
Associated acoustic parameters	$p_{r,\alpha}$	(MPa)	2.43					
	P	(mW)		-		259.97	223.04	#
	Min. [ $P_{\alpha}(z_s), I_{ta,\alpha}(z_s)$ ]	(mW)				48.55		
	$z_s$	(cm)				2.64		
	$z_{bp}$	(cm)				2.43		
	$z_b$	(cm)					2.6	
	z at max $I_{pi}$ $\alpha$	(cm)	2.47					
	$d_{eq}(z_b)$	(cm)					0.44	
	$f_{awf}$	(MHz)	2.5	-		2.5	2.5	#
	Dim of $A_{aprt}$	X(cm)		-		1.58	0.99	#
Y(cm)			-		1.3	1.3	#	
Other information	$t_d$	$\mu s$	1485.45					
	prf	(Hz)	43					
	$p_r$ at max $I_{pi}$	(MPa)	2.11					
	$d_{eq}$ at max $I_{pi}$	(cm)					0.98	
	$I_{pi}$ $\alpha$ at max $I_{pi}$	(W/cm <sup>2</sup> )	57					
	Focal length	FL <sub>X</sub> (cm)		-		0.4	0.28	#
FL <sub>Y</sub> (cm)			-		0.5	1.02	#	
Operating control conditions	Focal zone	(mm)	20	-		75	20	#
	TX Freq	(MHz)	2.5	-		2.5	2.5	#
	Frame rate	(Hz)	2	-		2	2	#
	Operating voltage	(V)	50	-		50	50	#
	Presets				-			#

(b) This probe is not intended for transcranial or neonatal cephalic uses

## Operating Mode: PW Doppler

Index Label		MI	TIS			TIB	TIC	
			Scan	Non-scan		Non-scan		
				A<1cm <sup>2</sup>	A>1cm <sup>2</sup>			
Maximum index value		0.9	-		2.84	4.69	(b)	
Associated acoustic parameters	$p_{r,\alpha}$	(MPa)	1.32					
	P	(mW)		-		316.7	313	#
	Min. [ $P_{\alpha}(z_s), I_{ta,\alpha}(z_s)$ ]	(mW)				172		
	$z_s$	(cm)				4.04		
	$z_{bp}$	(cm)				2.57		
	$z_b$	(cm)					5.95	
	z at max $I_{pi}$ $\alpha$	(cm)	6.04					
	$d_{eq}(z_b)$	(cm)					0.59	
	$f_{awf}$	(MHz)	2.25	-		2.25	2.25	#
	Dim of $A_{aprt}$	X(cm)		-		1.78	1.78	#
Y(cm)			-		1.3	1.3	#	
Other information	$t_d$	$\mu s$	0.84					
	prf	(Hz)	43					
	$p_r$ at max $I_{pi}$	(MPa)	2.03					
	$d_{eq}$ at max $I_{pi}$	(cm)					0.51	
	$I_{pi}$ $\alpha$ at max $I_{pi}$	(W/cm <sup>2</sup> )	112					
	Focal length	FL <sub>X</sub> (cm)		-		0.92	0.52	#
FL <sub>Y</sub> (cm)			-		0.55	0.55	#	
Operating control conditions	Focal zone	(mm)	86	-		180	110	#
	TX Freq	(MHz)	2.25	-		2.25	2.25	#
	Frame rate	(Hz)	3787	-		3787	3787	#
	Operating voltage	(V)	50	-		48	39	#
	Presets		General	-		General	General	#

(b) This probe is not intended for transcranial or neonatal cephalic uses



## Operating Mode: M Mode

Index Label		MI	TIS			TIB	TIC	
			Scan	Non-scan		Non-scan		
				A<1cm <sup>2</sup>	A>1cm <sup>2</sup>			
Maximum index value		1.5	-		0.89	4.54	(b)	
Associated acoustic parameters	$p_{r,\alpha}$	(MPa)	2.79					
	P	(mW)		-		61.2	47.3	#
	Min. [ $P_{\alpha}(z_s), I_{ta,\alpha}(z_s)$ ]	(mW)				13.85		
	$z_s$	(cm)				5.94		
	$z_{bp}$	(cm)				5.59		
	$z_b$	(cm)					5.62	
	z at max $I_{pi}$ $\alpha$	(cm)	1.57					
	$d_{eq}(z_b)$	(cm)					0.03	
	$f_{awf}$	(MHz)	3.5	-		3	2.25	#
	Dim of $A_{aprt}$	X(cm)		-		10.94	4.68	#
Y(cm)			-		1.3	1.3	#	
Other information	$t_d$	$\mu s$	0.39					
	prf	(Hz)	1000					
	$p_r$ at max $I_{pi}$	(MPa)	3.17					
	$d_{eq}$ at max $I_{pi}$	(cm)					0.87	
	$I_{pi}$ $\alpha$ at max $I_{pi}$	(W/cm <sup>2</sup> )	415					
	Focal length	FL <sub>X</sub> (cm)		-		3.2	1.72	#
FL <sub>Y</sub> (cm)			-		0.64	0.52	#	
Operating control conditions	Focal zone	(mm)	18	-		180	180	#
	TX Freq	(MHz)	3.33	-		3.33	2.25	#
	Frame rate	(Hz)	1000	-		1000	1000	#
	Operating voltage	(V)	70	-		42	60	#
	Presets		Prostate	-		Difficult	Ably mid, General	#

(b) This probe is not intended for transcranial or neonatal cephalic uses

# SE12-3 Transducer

Operating Mode: 2D echo mode

Index Label			MI	TIS			TIB	TIC
				Scan	Non-scan		Non-scan	
					A<1cm <sup>2</sup>	A>1cm <sup>2</sup>		
Maximum index value			1.6	0.61	-	-	-	(b)
Associated acoustic parameters	$p_{r,\alpha}$	(MPa)	3.76					
	P	(mW)		30.75	-	-	-	#
	Min. [ $P_{\alpha}(z_s), I_{ta,\alpha}(z_s)$ ]	(mW)				-		
	$z_s$	(cm)				-		
	$z_{bp}$	(cm)				-		
	$z_b$	(cm)					-	
	z at max $I_{pi \alpha}$	(cm)	0.65					
	$d_{eq}(z_b)$	(cm)					-	
	$f_{awf}$	(MHz)	5.63	4.38	-	-	-	#
	Dim of $A_{aprt}$	X(cm)		3.86	-	-	-	#
Y(cm)			0.6	-	-	-	#	
Other information	$t_d$	$\mu s$	0.23					
	prr	(Hz)	40					
	$p_r$ at max $I_{pi}$	(MPa)	4.08					
	$d_{eq}$ at max $I_{pi}$	(cm)					-	
	$I_{pi \alpha}$ at max $I_{pi}$	(W/cm <sup>2</sup> )	395					
	Focal length	FL <sub>X</sub> (cm)		1.2	-	-		
FL <sub>Y</sub> (cm)			0.21	-	-			
Operating control conditions	Focal zone	(mm)	7	80	-	-	-	
	TX Freq	(MHz)	5	4.5	-	-	-	
	Frame rate	(Hz)	40	40	-	-	-	
	Operating voltage	(V)	62	70	-	-	-	
	Presets			Gyne Prostate, General,	Early Ob	-	-	-

(b) This probe is not intended for transcranial or neonatal cephalic uses

## Operating Mode: Color Doppler

Index Label		MI	TIS			TIB	TIC	
			Scan	Non-scan		Non-scan		
				A<1cm <sup>2</sup>	A>1cm <sup>2</sup>			
Maximum index value		1.3	0.72	-	-	-	(b)	
Associated acoustic parameters	$p_{r,\alpha}$	(MPa)	3.19					
	P	(mW)		34.22	-		-	#
	Min. [ $P_{\alpha}(z_s), I_{ta,\alpha}(z_s)$ ]	(mW)				-		
	$z_s$	(cm)				-		
	$z_{bp}$	(cm)				-		
	$z_b$	(cm)					-	
	z at max $I_{pi \alpha}$	(cm)	0.5					
	$d_{eq}(z_b)$	(cm)					-	
	$f_{awf}$	(MHz)	6.5	6.5	-	-	-	#
	Dim of $A_{aprt}$	X(cm)		0.5	-	-	-	#
Y(cm)			0.6	-	-	-	#	
Other information	$t_d$	$\mu s$	0.41					
	prf	(Hz)	199					
	$p_r$ at max $I_{pi}$	(MPa)	3.58					
	$d_{eq}$ at max $I_{pi}$	(cm)					-	
	$I_{pi \alpha}$ at max $I_{pi}$	(W/cm <sup>2</sup> )	270					
	Focal length	FL <sub>X</sub> (cm)		0.28	-	-		
FL <sub>Y</sub> (cm)			0.2	-	-			
Operating control conditions	Focal zone	(mm)	14	40	-	-	-	
	TX Freq	(MHz)	6.43	5	-	-	-	
	Frame rate	(Hz)	199	247	-	-	-	
	Operating voltage	(V)	50	50	-	-	-	
	Presets			General	-	-	-	

TIS: 0.11 from CD - 0.61 from 2Decho

W0(mW) for TIS: 3.75 mW from CD – 30.75 mW from 2Decho

(b) This probe is not intended for transcranial or neonatal cephalic uses

### Operating Mode: SWE mode

Index Label		MI	TIS			TIB	TIC	
			Scan	Non-scan		Non-scan		
				A<1cm <sup>2</sup>	A>1cm <sup>2</sup>			
Maximum index value		1.6	-	0.81		1.25	(b)	
Associated acoustic parameters	$p_{r,\alpha}$	(MPa)	3.32					
	P	(mW)		-	44.14		44.14	#
	Min. [ $P_{\alpha}(z_s), I_{ta,\alpha}(z_s)$ ]	(mW)						
	$z_s$	(cm)						
	$z_{bp}$	(cm)						
	$z_b$	(cm)					2.04	
	z at max $I_{pi} \alpha$	(cm)	2.04					
	$d_{eq}(z_b)$	(cm)					0.23	
	$f_{awf}$	(MHz)	4.06	-	4.06		4.06	#
	Dim of $A_{aprt}$	X(cm)		-	0.6		0.6	#
Y(cm)			-	0.6		0.6	#	
Other information	$t_d$	$\mu s$	541					
	prr	(Hz)	1					
	$p_r$ at max $I_{pi}$	(MPa)	3.96					
	$d_{eq}$ at max $I_{pi}$	(cm)					0.24	
	$I_{pi} \alpha$ at max $I_{pi}$	(W/cm <sup>2</sup> )	290					
	Focal length	FL <sub>X</sub> (cm)		-	0.36		0.36	
FL <sub>Y</sub> (cm)			-	0.2		0.2		
Operating control conditions	Focal zone	(mm)	35	-	35		35	
	TX Freq	(MHz)	4	-	4		4	
	Frame rate	(Hz)	1	-	1		1	
	Operating voltage	(V)	63	-	63		63	
	Presets							

TIS: 0.25 from Push - 0.61 from 2Decho - 0.51 from Flat

TIB: 0.69 from Push - 0.61 from 2Decho - 0.51 from Flat

W0(mW) for TIS and TIB: 12.92 mW from Push - 30.76 mW from  
2Decho - 28.55 mW from Flat

(b) This probe is not intended for transcranial or neonatal cephalic uses

## Operating Mode: PW mode

Index Label		MI	TIS			TIB	TIC	
			Scan	Non-scan		Non-scan		
				A<1cm <sup>2</sup>	A>1cm <sup>2</sup>			
Maximum index value		1.2	-	1.4		2.59	(b)	
Associated acoustic parameters	$p_{r,\alpha}$	(MPa)	2.62					
	P	(mW)		-	62.45		48.47	#
	Min. [ $P_{\alpha}(z_s), I_{ta,\alpha}(z_s)$ ]	(mW)						
	$z_s$	(cm)						
	$z_{bp}$	(cm)						
	$z_b$	(cm)					0.6	
	z at max $I_{pi}$ $\alpha$	(cm)	2.1					
	$d_{eq}(z_b)$	(cm)					0.35	
	$f_{awf}$	(MHz)	4.63	-	4.75		4.5	#
	Dim of $A_{aprt}$	X(cm)		-	0.79		0.13	#
Y(cm)			-	0.6		0.6	#	
Other information	$t_d$	$\mu s$	0.43					
	prf	(Hz)	2396					
	$p_r$ at max $I_{pi}$	(MPa)	3.62					
	$d_{eq}$ at max $I_{pi}$	(cm)					0.53	
	$I_{pi}$ $\alpha$ at max $I_{pi}$	(W/cm <sup>2</sup> )	272					
	Focal length	FL <sub>X</sub> (cm)		-	0.44		0.8	
FL <sub>Y</sub> (cm)			-	0.22		0.24		
Operating control conditions	Focal zone	(mm)	40	-	60		7	
	TX Freq	(MHz)	4.5	-	4.5		4.5	
	Frame rate	(Hz)	2396	-	15195		15195	
	Operating voltage	(V)	50	-	30		50	
	Presets			General				

(b) This probe is not intended for transcranial or neonatal cephalic uses



## Operating Mode: M Mode

Index Label		MI	TIS			TIB	TIC	
			Scan	Non-scan		Non-scan		
				A<1cm <sup>2</sup>	A>1cm <sup>2</sup>			
Maximum index value		1.6	-	-	1.0	1.99	0.89	
Associated acoustic parameters	$p_{r,\alpha}$	(MPa)	3.59					
	P	(mW)		-	-	62.7	17.33	62.7
	Min. [ $P_{\alpha}(z_s), I_{ta,\alpha}(z_s)$ ]	(mW)				28.24		
	$z_s$	(cm)				2.63		
	$z_{bp}$	(cm)				2.63		
	$z_b$	(cm)					2.2	
	z at max $I_{pi}$ $\alpha$	(cm)	1.7					
	$d_{eq}(z_b)$	(cm)					0.01	
	$f_{awf}$	(MHz)	4.57			4.38	4.5	4.38
	Dim of $A_{aprt}$	X(cm)		-		3.86	0.85	3.86
Y(cm)			-		0.6	0.6	0.6	
Other information	$t_d$	$\mu s$	0.41					
	prf	(Hz)	1000					
	$p_r$ at max $I_{pi}$	(MPa)	4.53					
	$d_{eq}$ at max $I_{pi}$	(cm)					0.3	
	$I_{pi}$ $\alpha$ at max $I_{pi}$	(W/cm <sup>2</sup> )	451					
	Focal length	FL <sub>X</sub> (cm)		-		1.2	0.48	1.2
FL <sub>Y</sub> (cm)			-		0.21	0.18	0.21	
Operating control conditions	Focal zone	(mm)	14	-		80	60	80
	TX Freq	(MHz)	4.5	-		4.5	4.5	4.5
	Frame rate	(Hz)	1000	-		1000	1000	1000
	Operating voltage	(V)	70	-		70	70	70
	Presets		Early OB	-		Early OB	Gyne	Early OB

# SLV16-5 Transducer

Operating Mode: 2D echo mode

Index Label			MI	TIS		TIB	TIC	
				Scan	Non-scan			Non-scan
					A<1cm <sup>2</sup>	A>1cm <sup>2</sup>		
Maximum index value			1.6	0.16	-	-	(b)	
Associated acoustic parameters	$p_{r,\alpha}$	(MPa)	3.76					
	P	(mW)		8.33	-		-	#
	Min. [ $P_{\alpha}(z_s), I_{ta,\alpha}(z_s)$ ]	(mW)				-		
	$z_s$	(cm)				-		
	$z_{bp}$	(cm)				-		
	$z_b$	(cm)					-	
	z at max $I_{pi \alpha}$	(cm)	0.95					
	$d_{eq}(z_b)$	(cm)					-	
	$f_{awf}$	(MHz)	5.5	5.375	-	-	-	#
	Dim of $A_{aprt}$	X(cm)		2.02	-	-	-	#
Y(cm)			0.5	-	-	-	#	
Other information	$t_d$	$\mu s$	0.25					
	prr	(Hz)	64					
	$p_r$ at max $I_{pi}$	(MPa)	4.15					
	$d_{eq}$ at max $I_{pi}$	(cm)					-	
	$I_{pi \alpha}$ at max $I_{pi}$	(W/cm <sup>2</sup> )	444					
	Focal length	FL <sub>X</sub> (cm)		1.10	-	-		
FL <sub>Y</sub> (cm)			0.16	-	-			
Operating control conditions	Focal zone	(mm)	7	68	-	-	-	
	TX Freq	(MHz)	4.5	9	-	-	-	
	Frame rate	(Hz)	64	22	-	-	-	
	Operating voltage	(V)	67	57	-	-	-	
	Presets			Breast, General, Phantom				

(b) This probe is not intended for transcranial or neonatal cephalic uses

## Operating Mode: Color Doppler

Index Label		MI	TIS				TIB	TIC
			Scan	Non-scan		Non-scan		
				A<1cm <sup>2</sup>	A>1cm <sup>2</sup>			
Maximum index value		1.4	0.93	-	-	-	(b)	
Associated acoustic parameters	$p_{r,\alpha}$	(MPa)	3.84					
	P	(mW)		24	-		-	#
	Min. [ $P_{\alpha}(z_s), I_{ta,\alpha}(z_s)$ ]	(mW)				-		
	$z_s$	(cm)				-		
	$z_{bp}$	(cm)				-		
	$z_b$	(cm)					-	
	z at max $I_{pi} \alpha$	(cm)	1.43					
	$d_{eq}(z_b)$	(cm)					-	
	$f_{awf}$	(MHz)	7.5	9	-	-	-	#
	Dim of $A_{aprt}$	X(cm)		2.26	-	-	-	#
Y(cm)			0.5	-	-	-	#	
Other information	$t_d$	$\mu s$	0.46					
	prf	(Hz)	97					
	$p_r$ at max $I_{pi}$	(MPa)	5.39					
	$d_{eq}$ at max $I_{pi}$	(cm)					-	
	$I_{pi} \alpha$ at max $I_{pi}$	(W/cm <sup>2</sup> )	556					
	Focal length	FL <sub>X</sub> (cm)		0.99	-	-		
FL <sub>Y</sub> (cm)			0.1	-	-			
Operating control conditions	Focal zone	(mm)	22	68	-	-	-	
	TX Freq	(MHz)	7.5	9	-	-	-	
	Frame rate	(Hz)	97	100	-	-	-	
	Operating voltage	(V)	47	47	-	-	-	
	Presets		General		-	-	-	

TIS: 0.73 from CD - 0.2 from 2Decho

TIC: 0.47 from CD - 0.16 from 2Decho

W0(mW) for TIS: 17.08 mW from CD - 6.91 mW from 2Decho

W0(mW) for TIC: 22.57 mW from CD - 6.91 mW from 2Decho

(b) This probe is not intended for transcranial and neonatal cephalic uses

## Operating Mode: SWE mode

Index Label		MI	TIS		TIB	TIC		
			Scan	Non-scan			Non-scan	
				A<1cm <sup>2</sup>	A>1cm <sup>2</sup>			
Maximum index value		1.5	-		2.54	3.01	(b)	
Associated acoustic parameters	$p_{r,\alpha}$	(MPa)	3.65					
	P	(mW)		-		78.55	75.31	#
	Min. [ $P_{\alpha}(z_s), I_{ta,\alpha}(z_s)$ ]	(mW)				2.52		
	$z_s$	(cm)				1.79		
	$z_{bp}$	(cm)				1.79		
	$z_b$	(cm)					1.28	
	z at max $I_{pi}$ $\alpha$	(cm)	1.16					
	$d_{eq}(z_b)$	(cm)					0.13	
	$f_{awf}$	(MHz)	5.63	-		5.63	5.63	#
	Dim of $A_{aprt}$	X(cm)		-		0.74	1	#
Y(cm)			-		0.5	0.5	#	
Other information	$t_d$	$\mu s$	595					
	prf	(Hz)	1					
	$p_r$ at max $I_{pi}$	(MPa)	4.02					
	$d_{eq}$ at max $I_{pi}$	(cm)					0.14	
	$I_{pi}$ $\alpha$ at max $I_{pi}$	(W/cm <sup>2</sup> )	371					
	Focal length	FL <sub>X</sub> (cm)		-		0.24	0.28	
FL <sub>Y</sub> (cm)			-		0.16	0.12		
Operating control conditions	Focal zone	(mm)	10	-		15	20	
	TX Freq	(MHz)	5.63	-		5.63	5.63	
	Frame rate	(Hz)	1	-		1	1	
	Operating voltage	(V)	42	-		45	50	
	Presets							

TIS: 0.12 from Push - 0.16 from 2Decho - 2.26 from Flat

TIB: 0.55 from Push - 0.2 from 2Decho - 2.26 from Flat

TIC: 0.17 from Push - 0.16 from 2Decho - 1.1 from Flat

W0(mW) for TIS: 6.95 mW from Push – 8.33 mW from 2Decho - 63.27 mW from Flat

W0(mW) for TIB: 5.13 mW from Push - 6.91 mW from 2Decho - 63.27 mW from Flat

W0(mW) for TIC: 8.28 mW from Push - 6.91 mW from 2Decho - 63.27 mW from Flat

(b) This probe is not intended for transcranial and neonatal cephalic uses

### Operating Mode: PW mode

Index Label		MI	TIS			TIB	TIC	
			Scan	Non-scan		Non-scan		
				A<1cm <sup>2</sup>	A>1cm <sup>2</sup>			
Maximum index value		1.2	-	0.65		2.23	(b)	
Associated acoustic parameters	$p_{r,\alpha}$	(MPa)	2.74					
	P	(mW)		-	27.39		30.88	#
	Min. [ $P_{\alpha}(z_s), I_{ta,\alpha}(z_s)$ ]	(mW)						
	$z_s$	(cm)						
	$z_{bp}$	(cm)						
	$z_b$	(cm)					1.1	
	z at max $I_{pi}$ $\alpha$	(cm)	1.24					
	$d_{eq}(z_b)$	(cm)					0.21	
	$f_{awf}$	(MHz)	5.25	-	5.13		5	#
	Dim of $A_{aprt}$	X(cm)		-	0.84		0.84	#
Y(cm)			-	0.5		0.5	#	
Other information	$t_d$	$\mu s$	0.64					
	prf	(Hz)	2081					
	$p_r$ at max $I_{pi}$	(MPa)	3.18					
	$d_{eq}$ at max $I_{pi}$	(cm)					0.21	
	$I_{pi}$ $\alpha$ at max $I_{pi}$	(W/cm <sup>2</sup> )	338					
	Focal length	FL <sub>X</sub> (cm)		-	0.36		0.28	
FL <sub>Y</sub> (cm)			-	0.18		0.20		
Operating control conditions	Focal zone	(mm)	68	-	68		52	
	TX Freq	(MHz)	5	-	5		5	
	Frame rate	(Hz)	2081	-	2081		12568	
	Operating voltage	(V)	50	-	48		18	
	Presets		General					

(b) This probe is not intended for transcranial or neonatal cephalic uses



# SL10-2 Transducer

Operating Mode: 2D echo mode

Index Label			MI	TIS			TIB	TIC
				Scan	Non-scan		Non-scan	
					A<1cm <sup>2</sup>	A>1cm <sup>2</sup>		
Maximum index value			1.6	0.81	-	-	-	0.94
Associated acoustic parameters	$p_{r,\alpha}$	(MPa)	3.23					
	P	(mW)		48.59	-	-	-	48.59
	Min. [ $P_{\alpha}(z_s), I_{ta,\alpha}(z_s)$ ]	(mW)				-		
	$z_s$	(cm)				-		
	$z_{bp}$	(cm)				-		
	$z_b$	(cm)					-	
	z at max $I_{pi \alpha}$	(cm)	2.28					
	$d_{eq}(z_b)$	(cm)					-	
	$f_{awf}$	(MHz)	3.75	4	-	-	-	4
	Dim of $A_{aprt}$	X(cm)		2.6	-	-	-	2.6
Y(cm)			0.5	-	-	-	0.5	
Other information	$t_d$	$\mu s$	0.33					
	prr	(Hz)	43					
	$p_r$ at max $I_{pi}$	(MPa)	4.32					
	$d_{eq}$ at max $I_{pi}$	(cm)					-	
	$I_{pi \alpha}$ at max $I_{pi}$	(W/cm <sup>2</sup> )	440					
	Focal length	FL <sub>X</sub> (cm)		1.54	-	-		1.54
FL <sub>Y</sub> (cm)			0.22	-	-		0.22	
Operating control conditions	Focal zone	(mm)	40	90	-	-	-	90
	TX Freq	(MHz)	4.5	5	-	-	-	5
	Frame rate	(Hz)	58	36	-	-	-	36
	Operating voltage	(V)	62.39	72	-	-	-	72
	Presets			Carotid, General, Intestine, Breast,	General, Intestine, Breast,	-	-	-



## Operating Mode: Color Doppler

Index Label		MI	TIS			TIB	TIC	
			Scan	Non-scan		Non-scan		
				A<1cm <sup>2</sup>	A>1cm <sup>2</sup>			
Maximum index value		1.6	2.28	-	-	-	2.78	
Associated acoustic parameters	$p_{r,\alpha}$	(MPa)	3.5					
	P	(mW)		130.69	-	-	125.6	
	Min. [ $P_{\alpha}(z_s), I_{ta,\alpha}(z_s)$ ]	(mW)				-		
	$z_s$	(cm)				-		
	$z_{bp}$	(cm)				-		
	$z_b$	(cm)				-		
	z at max $I_{pi} \alpha$	(cm)	0.97					
	$d_{eq}(z_b)$	(cm)					-	
	$f_{awf}$	(MHz)	4.5	3.75	-	-	-	3.75
	Dim of $A_{aprt}$	X(cm)		1.72	-	-	-	1.72
Y(cm)			0.5	-	-	-	0.5	
Other information	$t_d$	$\mu s$	0.63					
	prr	(Hz)	43					
	$p_r$ at max $I_{pi}$	(MPa)	3.42					
	$d_{eq}$ at max $I_{pi}$	(cm)					-	
	$I_{pi} \alpha$ at max $I_{pi}$	(W/cm <sup>2</sup> )	581					
	Focal length	FL <sub>X</sub> (cm)		0.76	-	-	-	0.76
FL <sub>Y</sub> (cm)			0.18	-	-	-	0.18	
Operating control conditions	Focal zone	(mm)	14	88	-	-	-	88
	TX Freq	(MHz)	4.5	3.75	-	-	-	3.75
	Frame rate	(Hz)	91	88	-	-	-	88
	Operating voltage	(V)	64.26	65	-	-	-	65
	Presets		LowExtVenous	LowExtVenous	-	-	-	LowExtVenous

TIS: 1.47 from CD - 0.81 from 2Decho

TIC: 1.84 from CD - 0.94 from 2Decho

W0(mW) for TIS: 82.1 mW from CD - 48.59 mW from 2Decho

W0(mW) for TIC: 77.0 mW from CD - 48.59 mW from 2Decho

## Operating Mode: SWE Doppler

Index Label		MI	TIS		TIB	TIC		
			Scan	Non-scan			Non-scan	
				A<1cm <sup>2</sup>	A>1cm <sup>2</sup>			
Maximum index value		1.6	-		4.18	4.84	3.62	
Associated acoustic parameters	$p_{r,\alpha}$	(MPa)	3.18					
	P	(mW)		-		198.8	208.6	198.8
	Min. [ $P_{\alpha}(z_s) \cdot I_{ta,\alpha}(z_s)$ ]	(mW)				12.25		
	$z_s$	(cm)				1.98		
	$z_{bp}$	(cm)				1.98		
	$z_b$	(cm)					2.07	
	z at max $I_{pi} \alpha$	(cm)	1.95					
	$d_{eq}(z_b)$	(cm)					0.31	
	$f_{awf}$	(MHz)	4.1	-		4.1	4.1	4.1
	Dim of $A_{aprt}$	X(cm)		-		2.74	2	2.74
Y(cm)			-		0.5	0.5	0.5	
Other information	$t_d$	$\mu s$	541					
	prf	(Hz)	1					
	$p_r$ at max $I_{pi}$	(MPa)	3.55					
	$d_{eq}$ at max $I_{pi}$	(cm)					0.35	
	$I_{pi} \alpha$ at max $I_{pi}$	(W/cm <sup>2</sup> )	292					
	Focal length	FL <sub>X</sub> (cm)		-		0.88	0.88	0.88
		FL <sub>Y</sub> (cm)		-		0.18	0.18	0.18
Operating control conditions	Focal zone	(mm)	20	-		55	40	55
	TX Freq	(MHz)	4	-		4	4	4
	Frame rate	(Hz)	1	-		1	1	1
	Operating voltage	(V)	40	-		50	50	50
	Presets			-		General	General	General

TIS: 0.61 from Push - 0.81 from 2Decho - 2.76 from Flat

TIB: 1.27 from Push - 0.81 from 2Decho - 2.76 from Flat

TIC: 0.62 from Push - 0.94 from 2Decho - 2.06 from Flat

W0(mW) for TIS: 21.47 mW from Push - 48.59 mW from 2Decho - 128.76 mW from Flat

W0(mW) for TIB: 31.23 mW from Push - 48.59 mW from 2Decho - 128.76 mW from Flat

W0(mW) for TIC: 21.47 mW from Push - 48.59 mW from 2Decho - 128.76 mW from Flat

## Operating Mode: PW Doppler

Index Label		MI	TIS			TIB	TIC	
			Scan	Non-scan		Non-scan		
				A<1cm <sup>2</sup>	A>1cm <sup>2</sup>			
Maximum index value		0.9	-	1.50		3.45	2.71	
Associated acoustic parameters	$p_{r,\alpha}$	(MPa)	1.79					
	P	(mW)		-	82.44		81.68	29.94
	Min. [ $P_{\alpha}(z_s), I_{ta,\alpha}(z_s)$ ]	(mW)						
	$z_s$	(cm)						
	$z_{bp}$	(cm)						
	$z_b$	(cm)					2	
	z at max $I_{pi}$ $\alpha$	(cm)	1.96					
	$d_{eq}(z_b)$	(cm)					0.31	
	$f_{awf}$	(MHz)	4.13	-	3.75		3.75	3.75
	Dim of $A_{aprt}$	X(cm)		-	1.2		1.2	0.12
Y(cm)			-	0.5		0.5	0.5	
Other information	$t_d$	$\mu s$	0.43					
	prf	(Hz)	7792					
	$p_r$ at max $I_{pi}$	(MPa)	2.16					
	$d_{eq}$ at max $I_{pi}$	(cm)					0.30	
	$I_{pi}$ $\alpha$ at max $I_{pi}$	(W/cm <sup>2</sup> )	162					
	Focal length	FL <sub>X</sub> (cm)		-	0.38		0.44	0.22
FL <sub>Y</sub> (cm)			-	0.27		0.26	0.5	
Operating control conditions	Focal zone	(mm)	30	-	68		88	7
	TX Freq	(MHz)	3.75	-	3.75		3.75	3.75
	Frame rate	(Hz)	7792	-	7792		10714	7792
	Operating voltage	(V)	42	-	27		18	50
	Presets		General	-	General		General	General

# SMC12-3 Transducer

Operating Mode: 2D echo mode

Index Label			MI	TIS			TIB	TIC
				Scan	Non-scan		Non-scan	
					A<1cm <sup>2</sup>	A>1cm <sup>2</sup>		
Maximum index value			1.7	0.35	-	-	-	0.38
Associated acoustic parameters	$p_{r,\alpha}$	(MPa)	4.31					
	P	(mW)		17.1	-		-	16.18
	Min. [ $P_{\alpha}(z_s), I_{ta,\alpha}(z_s)$ ]	(mW)				-		
	$z_s$	(cm)				-		
	$z_{bp}$	(cm)				-		
	$z_b$	(cm)					-	
	z at max $I_{pi \alpha}$	(cm)	0.51					
	$d_{eq}(z_b)$	(cm)					-	
	$f_{awf}$	(MHz)	6.63	4.25	-	-	-	4.25
	Dim of $A_{aprt}$	X(cm)		1.53	-	-	-	1.53
Y(cm)			0.6	-	-	-	0.6	
Other information	$t_d$	$\mu s$	0.18					
	prr	(Hz)	43					
	$p_r$ at max $I_{pi}$	(MPa)	3.74					
	$d_{eq}$ at max $I_{pi}$	(cm)					-	
	$I_{pi \alpha}$ at max $I_{pi}$	(W/cm <sup>2</sup> )	504					
	Focal length	FL <sub>X</sub> (cm)		0.88	-	-	-	0.88
FL <sub>Y</sub> (cm)			0.24	-	-	-	0.24	
Operating control conditions	Focal zone	(mm)	7	88	-	-	-	88
	TX Freq	(MHz)	7.5	7.5	-	-	-	7.5
	Frame rate	(Hz)	60	54	-	-	-	54
	Operating voltage	(V)	52.16	60.58	-	-	-	60.58
	Presets		General	LowExtVen	Carotid, General,	-	-	- LowExtVen



## Operating Mode: Color Doppler

Index Label		MI	TIS			TIB	TIC	
			Scan	Non-scan		Non-scan		
				A<1cm <sup>2</sup>	A>1cm <sup>2</sup>			
Maximum index value		1.6	0.72	-	-	-	1	
Associated acoustic parameters	$p_{r,\alpha}$	(MPa)	3.45					
	P	(mW)		29.28	-	-	32.13	
	Min. [ $P_{\alpha}(z_s), I_{ta,\alpha}(z_s)$ ]	(mW)				-		
	$z_s$	(cm)				-		
	$z_{bp}$	(cm)				-		
	$z_b$	(cm)					-	
	z at max $I_{pi \alpha}$	(cm)	0.91					
	$d_{eq}(z_b)$	(cm)					-	
	$f_{awf}$	(MHz)	4.25	6.38	-	-	-	4.25
	Dim of $A_{aprt}$	X(cm)		0.52	-	-	-	0.48
Y(cm)			0.6	-	-	-	0.6	
Other information	$t_d$	$\mu s$	0.66					
	prf	(Hz)	43					
	$p_r$ at max $I_{pi}$	(MPa)	3.5					
	$d_{eq}$ at max $I_{pi}$	(cm)					-	
	$I_{pi \alpha}$ at max $I_{pi}$	(W/cm <sup>2</sup> )	413					
	Focal length	FL <sub>X</sub> (cm)		0.24	-	-	-	0.36
FL <sub>Y</sub> (cm)			0.36	-	-	-	0.35	
Operating control conditions	Focal zone	(mm)	68	40	-	-	-	68
	TX Freq	(MHz)	4.5	6.43	-	-	-	4.5
	Frame rate	(Hz)	90	203	-	-	-	181
	Operating voltage	(V)	66.84	50	-	-	-	66.84
	Presets		General	Carotid General, Phantom, LowExtArterial,	-	-	-	General

## Operating Mode: SWE Doppler

Index Label		MI	TIS			TIB	TIC	
			Scan	Non-scan		Non-scan		
				A<1cm <sup>2</sup>	A>1cm <sup>2</sup>			
Maximum index value		1.6	-	2.42		2.79	2.43	
Associated acoustic parameters	$p_{r,\alpha}$	(MPa)	3.39					
	P	(mW)		-	127.08		127.08	125.61
	Min. [ $P_{\alpha}(z_s), I_{ta,\alpha}(z_s)$ ]	(mW)						
	$z_s$	(cm)						
	$z_{bp}$	(cm)						
	$z_b$	(cm)					1.8	
	z at max $I_{pi} \alpha$	(cm)	1.65					
	$d_{eq}(z_b)$	(cm)					0.19	
	$f_{awf}$	(MHz)	4.1	-	4.1		4.1	4.1
	Dim of $A_{aprt}$	X(cm)		-	0.45		0.45	0.45
Y(cm)			-	0.6		0.6	0.6	
Other information	$t_d$	$\mu s$	500.57					
	prf	(Hz)	43					
	$p_r$ at max $I_{pi}$	(MPa)	3.38					
	$d_{eq}$ at max $I_{pi}$	(cm)					0.22	
	$I_{pi} \alpha$ at max $I_{pi}$	(W/cm <sup>2</sup> )	56					
	Focal length	FL <sub>X</sub> (cm)		-	0.28		0.28	0.32
		FL <sub>Y</sub> (cm)		-	0.22		0.22	0.32
Operating control conditions	Focal zone	(mm)	25	-	30		30	45
	TX Freq	(MHz)	4	-	4		4	4
	Frame rate	(Hz)	1	-	1		1	1
	Operating voltage	(V)	56	-	60		60	60
	Presets		General	-	General		General	General

## Operating Mode: PW Doppler

Index Label		MI	TIS			TIB	TIC	
			Scan	Non-scan		Non-scan		
				A<1cm <sup>2</sup>	A>1cm <sup>2</sup>			
Maximum index value		1.2	-	1.43		3.29	1.94	
Associated acoustic parameters	$p_{r,\alpha}$	(MPa)	2.52					
	P	(mW)		-	60.03		71.95	71.95
	Min. [ $P_{\alpha}(z_s), I_{ta,\alpha}(z_s)$ ]	(mW)						
	$z_s$	(cm)						
	$z_{bp}$	(cm)						
	$z_b$	(cm)					2.15	
	z at max $I_{pi \alpha}$	(cm)	1.4					
	$d_{eq}(z_b)$	(cm)					0.25	
	$f_{awf}$	(MHz)	4.5	-	4.88		4.5	4.5
	Dim of $A_{aprt}$	X(cm)		-	0.76		0.76	0.76
Y(cm)			-	0.6		0.6	0.6	
Other information	$t_d$	$\mu s$	0.61					
	prf	(Hz)	43					
	$p_r$ at max $I_{pi}$	(MPa)	3.17					
	$d_{eq}$ at max $I_{pi}$	(cm)					0.52	
	$I_{pi \alpha}$ at max $I_{pi}$	(W/cm <sup>2</sup> )	276					
	Focal length	FL <sub>X</sub> (cm)		-	0.32		0.32	0.32
FL <sub>Y</sub> (cm)			-	0.22		0.2	0.2	
Operating control conditions	Focal zone	(mm)	60	-	60		60	60
	TX Freq	(MHz)	4.5	-	4.5		4.5	4.5
	Frame rate	(Hz)	2396	-	15195		15195	15195
	Operating voltage	(V)	50	-	48.3		33.03	33.03
	Presets		General	-	General		General	General



# 12 References



## General References

Abbott, JG. Rationale and derivation of MI and TI - a review. *Ultrasound in Med. and Biol.* 25:431-441; 1999.

American Institute of Ultrasound in Medicine (AIUM). Bioeffects and safety of diagnostic ultrasound. Laurel, MD: AIUM Publications; 1993.

American Institute of Ultrasound in Medicine/National Electrical Manufacturers Association (AIUM/NEMA). Standard for real-time display of thermal and mechanical acoustic output indices on diagnostic ultrasound equipment, Revision 1. Laurel, MD: AIUM Publications; 1998a.

American Institute of Ultrasound in Medicine/National Electrical Manufacturers Association (AIUM/NEMA). Acoustic output measurement standard for diagnostic ultrasound equipment. Laurel, MD: AIUM Publications; 1998b.

American Institute of Ultrasound in Medicine (AIUM). Medical ultrasound safety. Rockville, MD: AIUM Publications; 2002.

American Institute of Ultrasound in Medicine (AIUM). Standard Methods for Measuring Performance of Pulse Echo Ultrasound Imaging Equipment. Rockville, MD: AIUM Publications; 1991.

American Institute of Ultrasound in Medicine (AIUM). Methods for Measuring Performance of Pulse-Echo Ultrasound Equipment, Part II: Digital Methods. Rockville, MD: AIUM Publications; 1995a.

American Institute of Ultrasound in Medicine (AIUM). AIUM Quality Assurance Manual for Gray-Scale Ultrasound Scanners. Rockville, MD: AIUM Publications; 1995b.

American Institute Of Ultrasound In Medicine. Standard For Real-Time Display Of Thermal And Mechanical Acoustic Output Indices On Diagnostic Ultrasound Equipment. Laurel, Maryland: AIUM, 1992.

American Institute of Ultrasound in Medicine (AIUM). Mechanical Bioeffects from Diagnostic Ultrasound: AIUM Consensus Statements. *J. Ultrasound in Medicine* 19: number 2; (February 2000). (Also available from AIUM Publications.).

Apfel, R.E. and Holland, C.K. Gauging the likelihood of cavitation from short-pulse, low duty cycle diagnostic ultrasound. *Ultrasound in Med. and Biol.* 17:179-185;1991.

Baggs, R., Penney, D.P., Cox, C., Child, S.Z., Raeman, C.H., Dalecki, D. and Carstensen, E.L. Thresholds for ultrasonically induced lung hemorrhage in neonatal swine. *Ultrasound in Med. and Biol.* 22:119-128; 1996.

Barnett, S.B., ter Haar, G.R., Ziskin, M.C., Rott, H.D., Duck, F.A. and Maeda, K. International recommendations and guidelines for the safe use of diagnostic ultrasound in medicine. *Ultrasound in Med. and Biol.* 26:355-366; 2000.

Bly, S.H.P., Vlahovich, S., Mabee, P.R. and Hussey, R.G. Computed estimates of maximum temperature elevations in fetal tissues during transabdominal pulsed Doppler examinations. *Ultrasound in Med. and Biol.* 18:389-397; 1992.

Bosward, K.L., Barnett, S.B., Wood, A.K.W., Edwards, M.J. and Kossoff, G. Heating of guinea-pig fetal brain during exposure to pulsed ultrasound. *Ultrasound in Med. and Biol.* 19:415-424; 1993.

Carstensen, E.L., Duck, F.A., Meltzer, R.S., Schwarz, K.Q., Keller, B. Bioeffects in echocardiography. *Echocardiography* 6:605-623; 1992.

Child, S.Z., Hartman, C.L., McHale, L.A and E.L. Carstensen. Lung damage from exposure to pulsed ultrasound. *Ultrasound in Med. and Biol.* 16:817-825; 1990.

Dalecki, D., Raeman CH, Child SZ, et al, . The influence of contrast agents on hemorrhage produced by lithotripter fields. *Ultrasound in Med. and Biol.* 23:1435-1439; 1997.

Dalecki, D., Child, S.Z., Raeman, C.H., Cox, C. and Carstensen, E.L. Ultrasonically induced lung hemorrhage in young swine. *Ultrasound in Med. and Biol.* 23:777-781; 1997.

Dalecki, D., Child, S.Z., Raeman, C.H. and Cox, C. Hemorrhage in murine fetuses exposed to pulsed ultrasound. *Ultrasound in Med. and Biol.* 25:1139-1144; 1999.

Doody, C. Porter, H., Duck, F.A. and Humphrey, V.F. In vitro heating of human fetal vertebra by pulsed diagnostic ultrasound. *Ultrasound in Med. and Biol.* 25:1289-1294; 1999.



Duck, F.A., Starritt, H.C., ter Haar, G.R. and Lunt, M.J. Surface heating of diagnostic ultrasound transducers. *Br. J. Radiology* 67:1005-1013; 1989.

Duggan, P.M., Liggins, G.C. and Barnett, S.B. Ultrasonic heating of the brain of the fetal sheep in utero. *Ultrasound in Med. and Biol.* 21:553-560; 1995.

Duggan, P.M. and McCowan, L.M.E. Reference Ranges and Ultrasonographic Exposure Conditions for Pulsed Doppler Sonographic Studies of the Fetal Internal Carotid Artery. *J Ultrasound in Medicine* 12:719 - 722; 1993.

Frizzell, L.A., Chen, E. and Lee, C. Effects of pulsed ultrasound on the mouse neonate: hind limb paralysis and lung hemorrhage. *Ultrasound in Med. and Biol.* 20:53-63; 1994.

Henderson, J., Willson, K., Jago, J.R. and Whittingham, T. A survey of the acoustic outputs of diagnostic ultrasound equipment in current clinical use. *Ultrasound in Med. and Biol.* 21:699-705; 1995.

Holland, C.K., Deng, C.X., Apfel, R.E., Alderman, J.L., Fernandez, L.A., and Taylor, K.J.W. Direct evidence of cavitation in vivo from diagnostic ultrasound. *Ultrasound in Med. and Biol.* 22:917-925; 1996.

Lele, P.P. Local hyperthermia by ultrasound for cancer therapy. In: Nyborg, W.L.; Ziskin, M.C., eds. *Biological effects of ultrasound. Clinics in diagnostic ultrasound, Vol.16.* New York: Churchill Livingstone:135-155; 1985.

Lopez, H. How to Interpret the Ultrasound Output Display Standard for Higher Acoustic Output Diagnostic Ultrasound Devices. *J. Ultrasound in Medicine, Vol 17,* pg 535 (1998).

Miller, D.L. and Gies, R.A. Gas-body-based contrast agent enhances vascular bioeffects of 1.09 Mhz ultrasound on mouse intestine. *Ultrasound in Med. and Biol.* 24:1201-1208; 1998.

Meltzer, R.S., Adsumelli, R., Risher, W.H., et al., Lack of lung hemorrhage in humans after intraoperative transesophageal echocardiography with ultrasound exposure conditions similar to those causing lung hemorrhage in laboratory animals. *J. Am. Soc. Echocardiography* 11:57-60; 1998.

National Council on Radiation Protection and Measurements (NCRP). Exposure criteria for medical diagnostic ultrasound: I. Criteria based on thermal mechanisms. Bethesda, MD: NCRP; June 1, 1992.

National Council on Radiation Protection and Measurements (NCRP). Exposure criteria for medical diagnostic ultrasound: II. Criteria based on mechanical mechanisms. Bethesda, MD: NCRP; in preparation

O'Brien, W.D. and Zachary, J.F. Lung damage assessment from exposure to pulsed-wave ultrasound in the rabbit, mouse and pig. *IEEE Trans Ultras Ferro, Freq Cont* 44: 473-485; 1997.

O'Neill, T.P., Winkler, A.J. and Wu, J. Ultrasound heating in a tissue-bone phantom. *Ultrasound in Med. and Biol.* 20:579-588; 1994.

Patton, C.A., Harris, G.R. and Phillips, R.A. Output Levels and Bioeffects Indices from Diagnostic Ultrasound Exposure Data Reported to the FDA. *IEEE Trans Ultras Ferro, Freq Cont* 41:353-359; 1994.

Ramnarine, K.V., Nassiri, D.K., Pearce, J.M., Joseph, A.E.A., Patel, R.H. and Varma, T.R. Estimation of in situ ultrasound exposure during obstetric examinations. *Ultrasound in Med. and Biol.* 19:319-329; 1993.

Shaw, A., Preston, R.C. and Bond, A.D. Assessment of the likely thermal index values for pulsed Doppler ultrasonic equipment - Stage I: calculation based on manufacturers' data. NPL Report CIRA(EXT) 018; 1997.

Shaw, A., Pay, N.M. and Preston, R.C. Assessment of the likely thermal index values for pulsed Doppler ultrasonic equipment - Stages II and III: experimental assessment of scanner/transducer combinations. NPL Report CMAM 12; 1998.

Siddiqi, T.A., O'Brien, W.D., Meyer, R.A., Sullivan, J.M. and Miodovnik, M. In situ human obstetrical ultrasound exposimetry: estimates of derating factors for each of three different tissue models. *Ultrasound in Med. and Biol.* 21:379-391; 1995.

Tarantal, A.F. and Canfield, D.R. Ultrasound-induced lung hemorrhage in the monkey. *Ultrasound in Med. and Biol.* 20:65-72; 1994.

U.S. Food and Drug Administration (FDA). Information for manufacturers seeking marketing clearance of diagnostic ultrasound systems and transducers. Rockville, MD: FDA; Sept 30, 1997.

World Federation for Ultrasound in Medicine and Biology (WFUMB)  
WFUMB Symposium on Safety and Standardisation in Medical  
Ultrasound, Chapter 1, ed., Barnett, S.B. and Kossoff, G. Ultrasound in  
Med. and Biol. 18:739-750; 1992.

World Federation for Ultrasound in Medicine and Biology (WFUMB)  
WFUMB Symposium on Safety of Ultrasound in Medicine. Conclusions  
and recommendations on thermal and non-thermal mechanisms for  
biological effects of ultrasound. ed., Barnett, S.B. Ultrasound in Med.  
and Biol. 24: Supplement 1, 1998.

Zachary, J.F. and O'Brien, W.D., Jr. Lung lesions induced by continuous-  
and pulsed-wave (diagnostic) ultrasound in mice, rabbits and pigs. Vet  
Pathol 32:43-54; 1995.

# Obstetrical References

## Fetal Growth Equations and Tables

### ABDOMINAL CIRCUMFERENCE (AC BY GA)

#### ASUM2000

**Name:** ASUM 2000

**Author:** ASUM

**Year:** 2000

**Reference:** ASUM and Campbell Westerway S , Ultrasonic fetal Measurement Standards for an Australian Population, ASUM, 2003

**Comments:** Fetal growth table generated from ASUM equations with polynomial interpretation of standard deviations

GA (week)	AC (mm)	+/- 2SD
11 weeks	49.3231 mm	8.9715 mm
12 weeks	61.4484 mm	9.50361 mm
13 weeks	73.4799 mm	10.1216 mm
14 weeks	85.4176 mm	10.8189 mm
15 weeks	97.2615 mm	11.5889 mm
16 weeks	109.012 mm	12.4251 mm
17 weeks	120.668 mm	13.321 mm
18 weeks	132.23 mm	14.2699 mm
19 weeks	143.699 mm	15.2653 mm
20 weeks	155.074 mm	16.3007 mm
21 weeks	166.355 mm	17.3694 mm

GA (week)	AC (mm)	+/- 2SD
22 weeks	177.542 mm	18.465 mm
23 weeks	188.636 mm	19.5808 mm
24 weeks	199.636 mm	20.7104 mm
25 weeks	210.542 mm	21.847 mm
26 weeks	221.354 mm	22.9843 mm
27 weeks	232.072 mm	24.1155 mm
28 weeks	242.696 mm	25.2342 mm
29 weeks	253.227 mm	26.3338 mm
30 weeks	263.664 mm	27.4078 mm
31 weeks	274.007 mm	28.4495 mm
32 weeks	284.256 mm	29.4524 mm
33 weeks	294.412 mm	30.41 mm
34 weeks	304.474 mm	31.3156 mm
35 weeks	314.442 mm	32.1628 mm
36 weeks	324.316 mm	32.945 mm
37 weeks	334.096 mm	33.6555 mm
38 weeks	343.782 mm	34.2879 mm
39 weeks	353.375 mm	34.8356 mm
40 weeks	362.874 mm	35.292 mm
41 weeks	372.279 mm	35.6506 mm

## CFEF2000

**Name:** CFEF 2000

**Author:** CFEF

**Year:** 2000

**Reference:** Crequat J, Duyme M and Brodaty G, Fetal growth charts by the French College of fetal ultrasonography and the Inserm U 155 , Biometry 2000, 28, pp 435-455, 2000

**Comments:** <http://cfef.org/>

GA (week)	AC (mm)	3%	10%	90%	97%
15 weeks	95 mm	80.7 mm	85.3 mm	104.4 mm	108.8 mm
16 weeks	106.4 mm	91.3 mm	96.1 mm	116.8 mm	121.6 mm
17 weeks	118 mm	101.7 mm	106.8 mm	129 mm	134 mm
18 weeks	129.2 mm	111.8 mm	117.4 mm	141 mm	146.6 mm
19 weeks	140.4 mm	122 mm	128 mm	153 mm	158.8 mm
20 weeks	151.4 mm	132 mm	138 mm	164.7 mm	171 mm
21 weeks	162.3 mm	141.6 mm	148.2 mm	176.3 mm	183 mm
22 weeks	173 mm	151.4 mm	158.2 mm	187.8 mm	194.7 mm
23 weeks	183.6 mm	160.9 mm	168.2 mm	199 mm	206.3 mm
24 weeks	194 mm	170.2 mm	177.8 mm	210.3 mm	218 mm
25 weeks	204.4 mm	179.3 mm	187.3 mm	221.3 mm	229.3 mm
26 weeks	214.5 mm	188.4 mm	196.7 mm	232.3 mm	240.6 mm
27 weeks	224.5 mm	197.3 mm	206 mm	243 mm	251.6 mm
28 weeks	234.4 mm	206.2 mm	215.1 mm	253.6 mm	262.6 mm
29 weeks	244 mm	214.7 mm	224 mm	264 mm	273.3 mm
30 weeks	253.6 mm	223.2 mm	232.8 mm	274.2 mm	283.7 mm
31 weeks	263 mm	231.6 mm	241.6 mm	284.2 mm	294.4 mm
32 weeks	272.2 mm	239.7 mm	250 mm	294.3 mm	304.6 mm
33 weeks	281.2 mm	247.8 mm	258.4 mm	304 mm	314.8 mm
34 weeks	290.2 mm	255.6 mm	266.7 mm	313.8 mm	324.8 mm
35 weeks	298.8 mm	263.2 mm	274.7 mm	323.3 mm	334.5 mm
36 weeks	307.4 mm	271 mm	282.6 mm	332.5 mm	344.3 mm
37 weeks	316 mm	278.3 mm	290.3 mm	341.7 mm	353.8 mm
38 weeks	324.7 mm	285.6 mm	298 mm	350.7 mm	363 mm
39 weeks	332.4 mm	292.7 mm	305.3 mm	359.6 mm	372.2 mm
40 weeks	339 mm	298 mm	311 mm	367 mm	380 mm

## Hadlock 1984

**Name:** Hadlock 1984

**Author:** Hadlock

**Year:** 1984

**Reference:** Hadlock F.P, Deter R.L, Harrist R.B. and Park S.K, Estimating fetal age: computer-assisted analysis of multiple fetal growth parameters, Radiology, 152, pp 497-501, 1984

GA (week)	AC (cm)	+/- 1SD
12 weeks	4.58288 cm	1.34 cm
12.5 weeks	5.26562 cm	1.34 cm
13 weeks	5.94338 cm	1.34 cm
13.5 weeks	6.61615 cm	1.34 cm
14 weeks	7.28392 cm	1.34 cm
14.5 weeks	7.9467 cm	1.34 cm
15 weeks	8.6045 cm	1.34 cm
15.5 weeks	9.25731 cm	1.34 cm
16 weeks	9.90512 cm	1.34 cm
16.5 weeks	10.5479 cm	1.34 cm
17 weeks	11.1858 cm	1.34 cm
17.5 weeks	11.8186 cm	1.34 cm
18 weeks	12.4465 cm	1.34 cm
18.5 weeks	13.0693 cm	1.34 cm
19 weeks	13.6872 cm	1.34 cm
19.5 weeks	14.3001 cm	1.34 cm
20 weeks	14.908 cm	1.34 cm
20.5 weeks	15.5109 cm	1.34 cm
21 weeks	16.1088 cm	1.34 cm
21.5 weeks	16.7017 cm	1.34 cm
22 weeks	17.2897 cm	1.34 cm
22.5 weeks	17.8726 cm	1.34 cm
23 weeks	18.4506 cm	1.34 cm
23.5 weeks	19.0235 cm	1.34 cm
24 weeks	19.5915 cm	1.34 cm
24.5 weeks	20.1545 cm	1.34 cm
25 weeks	20.7125 cm	1.34 cm

<b>GA (week)</b>	<b>AC (cm)</b>	<b>+/- 1SD</b>
25.5 weeks	21.2655 cm	1.34 cm
26 weeks	21.8135 cm	1.34 cm
26.5 weeks	22.3565 cm	1.34 cm
27 weeks	22.8946 cm	1.34 cm
27.5 weeks	23.4276 cm	1.34 cm
28 weeks	23.9557 cm	1.34 cm
28.5 weeks	24.4787 cm	1.34 cm
29 weeks	24.9968 cm	1.34 cm
29.5 weeks	25.5099 cm	1.34 cm
30 weeks	26.018 cm	1.34 cm
30.5 weeks	26.5211 cm	1.34 cm
31 weeks	27.0192 cm	1.34 cm
31.5 weeks	27.5123 cm	1.34 cm
32 weeks	28.0005 cm	1.34 cm
32.5 weeks	28.4836 cm	1.34 cm
33 weeks	28.9618 cm	1.34 cm
33.5 weeks	29.4349 cm	1.34 cm
34 weeks	29.9031 cm	1.34 cm
34.5 weeks	30.3663 cm	1.34 cm
35 weeks	30.8245 cm	1.34 cm
35.5 weeks	31.2777 cm	1.34 cm
36 weeks	31.7259 cm	1.34 cm
36.5 weeks	32.1691 cm	1.34 cm
37 weeks	32.6074 cm	1.34 cm
37.5 weeks	33.0406 cm	1.34 cm
38 weeks	33.4689 cm	1.34 cm
38.5 weeks	33.8921 cm	1.34 cm
39 weeks	34.3104 cm	1.34 cm
39.5 weeks	34.7237 cm	1.34 cm
40 weeks	35.132 cm	1.34 cm



## Merz1988

**Name:** Merz 1988

**Author:** Merz

**Year:** 1988

**Reference:** Merz E, Goldhofer W and Timor-Tritsch E , Ultrasound in Gynecology and Obstetrics, Textbook and Atlas, Georg Thieme Verlag , 1991

**Comments:** From Merz E, Habilitationsschrift, Mainz University Woman's Hospital, 1988

GA (week)	AC (mm)	5%	95%
12 weeks	58 mm	40 mm	76 mm
13 weeks	68 mm	50 mm	87 mm
14 weeks	79 mm	60 mm	98 mm
15 weeks	89 mm	69 mm	109 mm
16 weeks	99 mm	79 mm	119 mm
17 weeks	110 mm	89 mm	130 mm
18 weeks	120 mm	99 mm	141 mm
19 weeks	130 mm	108 mm	152 mm
20 weeks	140 mm	118 mm	162 mm
21 weeks	151 mm	128 mm	173 mm
22 weeks	161 mm	138 mm	184 mm
23 weeks	171 mm	148 mm	195 mm
24 weeks	182 mm	158 mm	205 mm
25 weeks	192 mm	167 mm	216 mm
26 weeks	202 mm	177 mm	227 mm
27 weeks	212 mm	187 mm	238 mm
28 weeks	223 mm	197 mm	248 mm
29 weeks	233 mm	207 mm	259 mm
30 weeks	243 mm	217 mm	270 mm
31 weeks	253 mm	227 mm	280 mm

GA (week)	AC (mm)	5%	95%
32 weeks	264 mm	237 mm	291 mm
33 weeks	274 mm	246 mm	302 mm
34 weeks	284 mm	256 mm	312 mm
35 weeks	295 mm	266 mm	323 mm
36 weeks	305 mm	276 mm	334 mm
37 weeks	315 mm	286 mm	344 mm
38 weeks	325 mm	296 mm	355 mm
39 weeks	336 mm	306 mm	365 mm
40 weeks	346 mm	316 mm	376 mm

## BIPARIETAL DIAMETER (BPD BY GA)

### ASUM2003

**Name:** ASUM 2003

**Author:** ASUM

**Year:** 2003

**Reference:** ASUM and Campbell Westerway S , Ultrasonic fetal Measurement Standards for an Australian Population, ASUM, 2003

**Comments:** Fetal growth table generated from ASUM equations with polynomial interpretation of standard deviations

GA (week)	BPD (mm)	+/- 2SD
11 weeks	15.5549 mm	2.92038 mm
12 weeks	19.3916 mm	3.32946 mm
13 weeks	23.1541 mm	3.67624 mm
14 weeks	26.8424 mm	3.96575 mm
15 weeks	30.4565 mm	4.20303 mm
16 weeks	33.9964 mm	4.39311 mm
17 weeks	37.4621 mm	4.54103 mm

GA (week)	BPD (mm)	+/- 2SD
18 weeks	40.8536 mm	4.65182 mm
19 weeks	44.1709 mm	4.73052 mm
20 weeks	47.414 mm	4.78216 mm
21 weeks	50.5829 mm	4.81176 mm
22 weeks	53.6776 mm	4.82438 mm
23 weeks	56.6981 mm	4.82504 mm
24 weeks	59.6444 mm	4.81877 mm
25 weeks	62.5165 mm	4.81061 mm
26 weeks	65.3144 mm	4.80559 mm
27 weeks	68.0381 mm	4.80875 mm
28 weeks	70.6876 mm	4.82512 mm
29 weeks	73.2629 mm	4.85974
30 weeks	75.764 mm	4.91763 mm
31 weeks	78.1909 mm	5.00384 mm
32 weeks	80.5436 mm	5.1234 mm
33 weeks	82.8221 mm	5.28134 mm
34 weeks	85.0264 mm	5.48269 mm
35 weeks	87.1565 mm	5.73249 mm
36 weeks	89.2124 mm	6.03577 mm
37 weeks	91.1941 mm	6.39757 mm
38 weeks	93.1016 mm	6.82292 mm
39 weeks	94.9349 mm	7.31686 mm
40 weeks	96.694 mm	7.88441 mm
41 weeks	98.3789 mm	8.53062 mm

CFEF2000

**Name:** CFEF 2000

**Author:** CFEF

**Year:** 2000

**Reference:** Crequat J, Duyme M and Brodaty G, Fetal growth charts by the French College of fetal ultrasonography and the Inserm U 155 , Biometry 2000, 28, pp 435-455, 2000

**Comments:** <http://cfef.org/>

GA (week)	FL (mm)	3%	10%	90%	97%
11 weeks	15.36 mm	12.08 mm	13.12 mm	17.6 mm	18.63 mm
12 weeks	19.4 mm	15.81 mm	16.96 mm	21.81 mm	22.92 mm
13 weeks	23.3 mm	19.47 mm	20.71 mm	25.92 mm	27.12 mm
14 weeks	27.14 mm	23.05 mm	24.36 mm	29.92 mm	31.23 mm
15 weeks	30.89 mm	26.56 mm	27.93 mm	33.82 mm	35.23 mm
16 weeks	34.53 mm	29.97 mm	31.41 mm	37.62 mm	39.08 mm
17 weeks	38.12 mm	33.32 mm	34.85 mm	41.35 mm	42.87 mm
18 weeks	41.58 mm	36.55 mm	38.15 mm	44.97 mm	46.56 mm
19 weeks	45 mm	39.76 mm	41.46 mm	48.52 mm	50.18 mm
20 weeks	48.22 mm	42.85 mm	44.56 mm	51.9 mm	53.64 mm
21 weeks	51.43 mm	45.86 mm	47.66 mm	55.23 mm	57 mm
22 weeks	54.53 mm	48.79 mm	50.61 mm	58.44 mm	60.3 mm
23 weeks	57.51 mm	51.63 mm	53.48 mm	61.54 mm	63.45 mm
24 weeks	60.42 mm	54.38 mm	56.31 mm	64.57 mm	66.5 mm
25 weeks	63.25 mm	57.04 mm	59 mm	67.48 mm	69.42 mm
26 weeks	65.94 mm	59.62 mm	61.64 mm	70.24 mm	72.27 mm
27 weeks	68.55 mm	62.12 mm	64.15 mm	72.92 mm	75 mm
28 weeks	71.03 mm	64.5 mm	66.61 mm	75.52 mm	77.6 mm
29 weeks	73.5 mm	66.84 mm	68.98 mm	77.97 mm	80.09 mm
30 weeks	75.8 mm	69.07 mm	71.21 mm	80.37 mm	82.52 mm
31 weeks	78 mm	71.22 mm	73.39 mm	82.63 mm	84.8 mm
32 weeks	80.16 mm	73.3 mm	75.49 mm	84.8 mm	87 mm
33 weeks	82.14 mm	75.24 mm	77.46 mm	86.84 mm	89.04 mm
34 weeks	84.07 mm	77.14 mm	79.36 mm	88.8 mm	91 mm
35 weeks	85.9 mm	78.94 mm	81.14 mm	90.61 mm	92.83 mm
36 weeks	87.61 mm	80.64 mm	82.88 mm	92.35 mm	94.56 mm
37 weeks	89.24 mm	82.27 mm	84.5 mm	93.97 mm	96.19 mm

GA (week)	FL (mm)	3%	10%	90%	97%
38 weeks	90.7 mm	83.78 mm	86 mm	95.42 mm	97.66 mm
39 weeks	92.1 mm	85.22 mm	87.43 mm	96.86 mm	99.05 mm
40 weeks	93.45 mm	86.57 mm	88.78 mm	98.13 mm	100.31 mm
41 weeks	94 mm	87 mm	89 mm	99 mm	101 mm

## Hadlock 1984

**Name:** Hadlock 1984

**Author:** Hadlock

**Year:** 1984

**Reference:** Hadlock F.P, Deter R.L, Harrist R.B. and Park S.K, Estimating fetal age: computer-assisted analysis of multiple fetal growth parameters, Radiology, 152, pp 497-501, 1984

GA (week)	BPD (cm)	+/- 1SD
12 weeks	1.73459 cm	0.3 cm
12.5 weeks	1.92586 cm	0.3 cm
13 weeks	2.11598 cm	0.3 cm
13.5 weeks	2.30492 cm	0.3 cm
14 weeks	2.49262 cm	0.3 cm
14.5 weeks	2.67903 cm	0.3 cm
15 weeks	2.86413 cm	0.3 cm
15.5 weeks	3.04784 cm	0.3 cm
16 weeks	3.23014 cm	0.3 cm
16.5 weeks	3.41098 cm	0.3 cm
17 weeks	3.59031 cm	0.3 cm
17.5 weeks	3.76808 cm	0.3 cm
18 weeks	3.94425 cm	0.3 cm
18.5 weeks	4.11877 cm	0.3 cm
19 weeks	4.2916 cm	0.3 cm
19.5 weeks	4.46269 cm	0.3 cm

<b>GA (week)</b>	<b>BPD (cm)</b>	<b>+/- 1SD</b>
20 weeks	4.632 cm	0.3 cm
20.5 weeks	4.79948 cm	0.3 cm
21 weeks	4.96508 cm	0.3 cm
21.5 weeks	5.12876 cm	0.3 cm
22 weeks	5.29047 cm	0.3 cm
22.5 weeks	5.45017 cm	0.3 cm
23 weeks	5.60781 cm	0.3 cm
23.5 weeks	5.76335 cm	0.3 cm
24 weeks	5.91674 cm	0.3 cm
24.5 weeks	6.06793 cm	0.3 cm
25 weeks	6.21687 cm	0.3 cm
25.5 weeks	6.36354 cm	0.3 cm
26 weeks	6.50786 cm	0.3 cm
26.5 weeks	6.64981 cm	0.3 cm
27 weeks	6.78934 cm	0.3 cm
27.5 weeks	6.92639 cm	0.3 cm
28 weeks	7.06093 cm	0.3 cm
28.5 weeks	7.1929 cm	0.3 cm
29 weeks	7.32227 cm	0.3 cm
29.5 weeks	7.44899 cm	0.3 cm
30 weeks	7.573 cm	0.3 cm
30.5 weeks	7.69427 cm	0.3 cm
31 weeks	7.81275 cm	0.3 cm
31.5 weeks	7.92839 cm	0.3 cm
32 weeks	8.04115 cm	0.3 cm
32.5 weeks	8.15098 cm	0.3 cm
33 weeks	8.25784 cm	0.3 cm
33.5 weeks	8.36168 cm	0.3 cm
34 weeks	8.46246 cm	0.3 cm
34.5 weeks	8.56012 cm	0.3 cm
35 weeks	8.65462 cm	0.3 cm
35.5 weeks	8.74593 cm	0.3 cm

GA (week)	BPD (cm)	+/- 1SD
36 weeks	8.83398 cm	0.3 cm
36.5 weeks	8.91875 cm	0.3 cm
37 weeks	9.00017 cm	0.3 cm
37.5 weeks	9.0782 cm	0.3 cm
38 weeks	9.15281 cm	0.3 cm
38.5 weeks	9.22394 cm	0.3 cm
39 weeks	9.29154 cm	0.3 cm
39.5 weeks	9.35558 cm	0.3 cm
40 weeks	9.416 cm	0.3 cm

## Jeanty1984

**Name:** Jeanty 1984

**Author:** Jeanty

**Year:** 1984

**Reference:** Jeanty P and Romero R, Obstetrical Ultrasound, McGraw-Hill, 1984

GA (week)	BPD (mm)	5%	95%
10 weeks	14 mm	9 mm	18 mm
11 weeks	17 mm	13 mm	22 mm
12 weeks	21 mm	16 mm	25 mm
13 weeks	24 mm	20 mm	29 mm
14 weeks	28 mm	23 mm	32 mm
15 weeks	31 mm	27 mm	36 mm
16 weeks	35 mm	30 mm	39 mm
17 weeks	38 mm	34 mm	43 mm
18 weeks	42 mm	37 mm	46 mm
19 weeks	45 mm	40 mm	49 mm

GA (week)	BPD (mm)	5%	95%
20 weeks	48 mm	44 mm	53 mm
21 weeks	51 mm	47 mm	56 mm
22 weeks	55 mm	50 mm	59 mm
23 weeks	58 mm	53 mm	62 mm
24 weeks	61 mm	56 mm	65 mm
25 weeks	64 mm	59 mm	68 mm
26 weeks	67 mm	62 mm	71 mm
27 weeks	70 mm	65 mm	74 mm
28 weeks	72 mm	68 mm	77 mm
29 weeks	75 mm	70 mm	79 mm
30 weeks	77 mm	73 mm	82 mm
31 weeks	79 mm	75 mm	84 mm
32 weeks	82 mm	77 mm	86 mm
33 weeks	84 mm	79 mm	88 mm
34 weeks	86 mm	81 mm	90 mm
35 weeks	87 mm	83 mm	92 mm
36 weeks	89 mm	84 mm	93 mm
37 weeks	90 mm	86 mm	95 mm
38 weeks	91 mm	87 mm	96 mm
39 weeks	93 mm	88 mm	97 mm
40 weeks	93 mm	89 mm	98 mm

## Merz1988

**Name:** Merz 1988

**Author:** Merz

**Year:** 1988

**Reference:** Merz E, Goldhofer W and Timor-Tritsch E , Ultrasound in Gynecology and Obstetrics, Textbook and Atlas, Georg Thieme Verlag , 1991



**Comments:** From Merz E, Habilitationsschrift, Mainz University Woman's Hospital, 1988

GA (week)	BPD (mm)	5%	95%
12 weeks	20 mm	15 mm	24 mm
13 weeks	24 mm	19 mm	28 mm
14 weeks	28 mm	23 mm	32 mm
15 weeks	31 mm	27 mm	36 mm
16 weeks	35 mm	30 mm	40 mm
17 weeks	39 mm	34 mm	44 mm
18 weeks	43 mm	38 mm	48 mm
19 weeks	46 mm	41 mm	51 mm
20 weeks	50 mm	45 mm	55 mm
21 weeks	53 mm	48 mm	58 mm
22 weeks	56 mm	51 mm	62 mm
23 weeks	60 mm	54 mm	65 mm
24 weeks	63 mm	57 mm	68 mm
25 weeks	66 mm	60 mm	71 mm
26 weeks	69 mm	63 mm	74 mm
27 weeks	72 mm	66 mm	77 mm
28 weeks	74 mm	69 mm	80 mm
29 weeks	77 mm	71 mm	83 mm
30 weeks	79 mm	74 mm	85 mm
31 weeks	82 mm	76 mm	88 mm
32 weeks	84 mm	78 mm	90 mm
33 weeks	86 mm	80 mm	92 mm
34 weeks	89 mm	82 mm	95 mm
35 weeks	91 mm	84 mm	97 mm
36 weeks	93 mm	86 mm	99 mm
37 weeks	94 mm	88 mm	101 mm
38 weeks	96 mm	90 mm	103 mm
39 weeks	98 mm	91 mm	104 mm
40 weeks	99 mm	93 mm	106 mm

## CROWN-RUMP LENGTH (CRL BY GA)

Jeanty1984

**Name:** Jeanty 1984

**Author:** Jeanty

**Year:** 1984

**Reference:** Jeanty P and Romero R, Obstetrical Ultrasound, McGraw-Hill, 1984

GA (wd)	CRL (mm)
6w0d	4 mm
6w1d	5 mm
6w2d	6 mm
6w3d	6 mm
6w4d	7 mm
6w5d	8 mm
6w6d	8 mm
7w0d	9 mm
7w1d	10 mm
7w2d	10 mm
7w3d	11 mm
7w4d	12 mm
7w5d	13 mm
7w6d	14 mm
8w0d	15 mm
8w1d	16 mm
8w2d	17 mm
8w3d	18 mm
8w4d	19 mm
8w5d	20 mm

GA (wd)	CRL (mm)
8w6d	21 mm
9w0d	22 mm
9w1d	23 mm
9w2d	24 mm
9w3d	26 mm
9w4d	27 mm
9w5d	28 mm
9w6d	29 mm
10w0d	31 mm
10w1d	32 mm
10w2d	33 mm
10w3d	35 mm
10w4d	36 mm
10w5d	38 mm
10w6d	39 mm
11w0d	40 mm
11w1d	41 mm
11w2d	43 mm
11w3d	44 mm
11w4d	46 mm
11w5d	47 mm
11w6d	49 mm

## Hansmann 1986

**Name:** Hansmann 1986

**Author:** Hansmann

**Year:** 1986

**Reference:** Hansmann, Hackeloer, Staudach and Wittman, Ultrasound Diagnosis in Obstetrics and Gynecology, Springer-Verlag, New York, 1986

<b>GA (wd)</b>	<b>Gest Age (mm)</b>	<b>+/- 2SD</b>
7w1d	6.9 mm	4.6 mm
7w2d	7.6 mm	4.85 mm
7w3d	8.3 mm	5.1 mm
7w4d	9 mm	5.35 mm
7w5d	9.6 mm	5.65 mm
7w6d	10.2 mm	5.9 mm
8w0d	10.8 mm	6.1 mm
8w1d	11.4 mm	6.4 mm
8w2d	12.1 mm	6.65 mm
8w3d	12.7 mm	6.9 mm
8w4d	13.3 mm	7.15 mm
8w5d	14 mm	7.4 mm
8w6d	14.7 mm	7.7 mm
9w0d	15.4 mm	7.95 mm
9w1d	16.2 mm	8.2 mm
9w3d	17.8 mm	8.7 mm
9w5d	19.6 mm	9.25 mm
10w0d	21.5 mm	9.75 mm
10w2d	23.6 mm	10.3 mm
10w4d	25.9 mm	10.75 mm
10w6d	28.3 mm	11.3 mm
11w2d	32.4 mm	12.05 mm
11w4d	35.3 mm	12.6 mm
11w6d	38.3 mm	13.1 mm
12w2d	43.2 mm	13.9 mm
12w4d	46.6 mm	14.55 mm
12w6d	50.2 mm	14.9 mm
13w2d	55.6 mm	15.65 mm
13w4d	59.4 mm	16.15 mm
13w6d	63.1 mm	16.7 mm
14w2d	68.8 mm	17.5 mm

GA (wd)	Gest Age (mm)	+/- 2SD
14w4d	72.6 mm	17.5 mm
14w6d	76.3 mm	18.5 mm
15w2d	81.8 mm	19.3 mm
15w4d	85.4 mm	19.8 mm
15w6d	88.9 mm	20.3 mm
16w2d	93.9 mm	21.1 mm
16w4d	97.1 mm	21.6 mm
16w6d	100.1 mm	22.1 mm
17w2d	104.4 mm	22.9 mm
17w4d	107 mm	23.4 mm
17w6d	109.5 mm	23.9 mm
18w2d	113 mm	24.7 mm
18w4d	115.1 mm	25.25 mm
18w6d	117.2 mm	25.7 mm
19w2d	120 mm	26.5 mm
19w4d	121.9 mm	27.05 mm
19w6d	123.7 mm	27.5 mm
20w1d	125.5 mm	28.05 mm
20w3d	127.4 mm	28.55 mm
20w5d	129.4 mm	29.1 mm
21w0d	131.6 mm	29.6 mm
21w1d	132.8 mm	29.85 mm
21w2d	134 mm	30.05 mm

## FEMUR LENGTH (FL BY GA)

ASUM2003

**Name:** ASUM 2003

**Author:** ASUM

**Year:** 2003

**Reference:** ASUM and Campbell Westerway S , Ultrasonic fetal Measurement Standards for an Australian Population, ASUM, 2003

**Comments:** Fetal growth table generated from ASUM equations with polynomial interpretation of standard deviations

GA (week)	FL (mm)	+/- 2SD
11 weeks	5.7551 mm	1.90788 mm
12 weeks	8.7962 mm	2.42423 mm
13 weeks	11.8149 mm	2.88716 mm
14 weeks	14.8088 mm	3.2994 mm
15 weeks	17.7755 mm	3.66367 mm
16 weeks	20.7126 mm	3.98271 mm
17 weeks	23.6177 mm	4.25924 mm
18 weeks	26.4884 mm	4.49599 mm
19 weeks	29.3223 mm	4.6957 mm
20 weeks	32.117 mm	4.8611 mm
21 weeks	34.8701 mm	4.99491 mm
22 weeks	37.5792 mm	5.09986 mm
23 weeks	40.2419 mm	5.17869 mm
24 weeks	42.8558 mm	5.23413 mm
25 weeks	45.4185 mm	5.2689 mm
26 weeks	47.9276 mm	5.28574 mm
27 weeks	50.3807 mm	5.28737 mm
28 weeks	52.7754 mm	5.27652 mm
29 weeks	55.1093 mm	5.25593 mm
30 weeks	57.38 mm	5.22833 mm
31 weeks	59.5851 mm	5.19644 mm
32 weeks	61.7222 mm	5.16299 mm
33 weeks	63.7889 mm	5.13072 mm
34 weeks	65.7828 mm	5.10236 mm
35 weeks	67.7015 mm	5.08063 mm
36 weeks	69.5426 mm	5.06827 mm
37 weeks	71.3037 mm	5.068 mm

GA (week)	FL (mm)	+/- 2SD
38 weeks	72.9824 mm	5.08255 mm
39 weeks	74.5763 mm	5.11466 mm
40 weeks	76.083 mm	5.16706 mm
41 weeks	77.5001 mm	5.24247 mm

## CFEF2000

**Name:** CFEF 2000

**Author:** CFEF

**Year:** 2000

**Reference:** Crequat J, Duyme M and Brodaty G, Fetal growth charts by the French College of fetal ultrasonography and the Inserm U 155 , Biometry 2000, 28, pp 435-455, 2000

**Comments:** <http://cfef.org/>

GA (week)	FL (mm)	3%	10%	90%	97%
12 weeks	6.33 mm	2.76 mm	3.89 mm	8.79 mm	10 mm
13 weeks	9.88 mm	2.76 mm	7.29 mm	12.42 mm	13.65 mm
14 weeks	13.33 mm	9.4 mm	10.65 mm	16 mm	17.27 mm
15 weeks	16.66 mm	12.56 mm	13.87 mm	19.44 mm	20.77 mm
16 weeks	19.95 mm	15.7 mm	17 mm	22.8 mm	24.18 mm
17 weeks	23.12 mm	18.74 mm	20.12 mm	26.13 mm	27.53 mm
18 weeks	26.23 mm	21.69 mm	23.14 mm	29.3 mm	30.8 mm
19 weeks	29.25 mm	24.59 mm	26.06 mm	32.44 mm	33.91 mm
20 weeks	32.23 mm	27.42 mm	28.94 mm	35.48 mm	37.03 mm
21 weeks	35.05 mm	30.12 mm	31.72 mm	38.41 mm	40 mm
22 weeks	37.87 mm	32.83 mm	34.39 mm	41.3 mm	42.91 mm
23 weeks	40.5 mm	35.34 mm	37 mm	44.03 mm	45.71 mm
24 weeks	43.16 mm	37.89 mm	39.58 mm	46.75 mm	48.42 mm
25 weeks	45.69 mm	40.33 mm	42.04 mm	49.36 mm	51.08 mm
26 weeks	48.17 mm	42.66 mm	44.4 mm	51.88 mm	53.62 mm

GA (week)	FL (mm)	3%	10%	90%	97%
27 weeks	50.53 mm	44.95 mm	46.72 mm	54.32 mm	56.09 mm
28 weeks	52.8 mm	47.13 mm	48.94 mm	56.64 mm	58.45 mm
29 weeks	54.94 mm	49.22 mm	51.06 mm	58.91 mm	60.72 mm
30 weeks	57.13 mm	51.3 mm	53.14 mm	61.08 mm	62.92 mm
31 weeks	59.15 mm	53.26 mm	55.13 mm	63.14 mm	65.04 mm
32 weeks	61.11 mm	55.12 mm	57.04 mm	65.19 mm	67.07 mm
33 weeks	63 mm	56.96 mm	58.87 mm	67.1 mm	69.03 mm
34 weeks	64.76 mm	58.69 mm	60.62 mm	68.88 mm	70.84 mm
35 weeks	66.47 mm	60.33 mm	62.29 mm	70.65 mm	72.63 mm
36 weeks	68.13 mm	61.9 mm	63.89 mm	72.34 mm	74.3 mm
37 weeks	69.63 mm	63.4 mm	65.36 mm	73.91 mm	75.89 mm
38 weeks	71.11 mm	64.81 mm	66.79 mm	75.38 mm	77.41 mm
39 weeks	72.48 mm	66.16 mm	68.19 mm	76.81 mm	78.84 mm
40 weeks	73.79 mm	67.42 mm	69.47 mm	78.14 mm	80.17 mm
41 weeks	74 mm	68 mm	70 mm	79 mm	81 mm

## Hadlock1984

**Name:** Hadlock 1984

**Author:** Hadlock

**Year:** 1984

**Reference:** Hadlock F.P, Deter R.L, Harrist R.B. and Park S.K, Estimating fetal age: computer-assisted analysis of multiple fetal growth parameters, Radiology, 152, pp 497-501, 1984

GA (week)	FL (cm)	+/- 1SD
12 weeks	0.7244 cm	0.3 cm
12.5 weeks	0.89625 cm	0.3 cm
13 weeks	1.0664 cm	0.3 cm
13.5 weeks	1.23485 cm	0.3 cm
14 weeks	1.4016 cm	0.3 cm



<b>GA (week)</b>	<b>FL (cm)</b>	<b>+/- 1SD</b>
14.5 weeks	1.56665 cm	0.3 cm
15 weeks	1.73 cm	0.3 cm
15.5 weeks	1.89165 cm	0.3 cm
16 weeks	2.0516 cm	0.3 cm
16.5 weeks	2.20985 cm	0.3 cm
17 weeks	2.3664 cm	0.3 cm
17.5 weeks	2.52125 cm	0.3 cm
18 weeks	2.6744 cm	0.3 cm
18.5 weeks	2.82585 cm	0.3 cm
19 weeks	2.9756 cm	0.3 cm
19.5 weeks	3.12365 cm	0.3 cm
20 weeks	3.27 cm	0.3 cm
20.5 weeks	3.41465 cm	0.3 cm
21 weeks	3.5576 cm	0.3 cm
21.5 weeks	3.69885 cm	0.3 cm
22 weeks	3.8384 cm	0.3 cm
22.5 weeks	3.97625 cm	0.3 cm
23 weeks	4.1124 cm	0.3 cm
23.5 weeks	4.24685 cm	0.3 cm
24 weeks	4.3796 cm	0.3 cm
24.5 weeks	4.51065 cm	0.3 cm
25 weeks	4.64 cm	0.3 cm
25.5 weeks	4.76765 cm	0.3 cm
26 weeks	4.8936 cm	0.3 cm
26.5 weeks	5.01785 cm	0.3 cm
27 weeks	5.1404 cm	0.3 cm
27.5 weeks	5.26125 cm	0.3 cm
28 weeks	5.3804 cm	0.3 cm
28.5 weeks	5.49785 cm	0.3 cm
29 weeks	5.6136 cm	0.3 cm
29.5 weeks	5.72765 cm	0.3 cm
30 weeks	5.84 cm	0.3 cm

GA (week)	FL (cm)	+/- 1SD
30.5 weeks	5.95065 cm	0.3 cm
31 weeks	6.0596 cm	0.3 cm
31.5 weeks	6.16685 cm	0.3 cm
32 weeks	6.2724 cm	0.3 cm
32.5 weeks	6.37625 cm	0.3 cm
33 weeks	6.4784 cm	0.3 cm
33.5 weeks	6.57885 cm	0.3 cm
34 weeks	6.6776 cm	0.3 cm
34.5 weeks	6.77465 cm	0.3 cm
35 weeks	6.87 cm	0.3 cm
35.5 weeks	6.96365 cm	0.3 cm
36 weeks	7.0556 cm	0.3 cm
36.5 weeks	7.14585 cm	0.3 cm
37 weeks	7.2344 cm	0.3 cm
37.5 weeks	7.32125 cm	0.3 cm
38 weeks	7.4064 cm	0.3 cm
38.5 weeks	7.48985 cm	0.3 cm
39 weeks	7.5716 cm	0.3 cm
39.5 weeks	7.65165 cm	0.3 cm
40 weeks	7.73 cm	0.3 cm

## Jeanty1984

**Name:** Jeanty 1984

**Author:** Jeanty

**Year:** 1984

**Reference:** Jeanty P and Romero R, Obstetrical Ultrasound, McGraw-Hill, 1984

GA (week)	FL (mm)	5%	95%
12 weeks	8 mm	4 mm	13 mm

<b>GA (week)</b>	<b>FL (mm)</b>	<b>5%</b>	<b>95%</b>
13 weeks	11 mm	6 mm	16 mm
14 weeks	14 mm	9 mm	18 mm
15 weeks	17 mm	12 mm	21 mm
16 weeks	20 mm	15 mm	24 mm
17 weeks	23 mm	18 mm	27 mm
18 weeks	25 mm	21 mm	30 mm
19 weeks	28 mm	24 mm	33 mm
20 weeks	31 mm	26 mm	36 mm
21 weeks	34 mm	29 mm	38 mm
22 weeks	36 mm	32 mm	41 mm
23 weeks	39 mm	35 mm	44 mm
24 weeks	42 mm	37 mm	46 mm
25 weeks	44 mm	40 mm	49 mm
26 weeks	47 mm	42 mm	51 mm
27 weeks	49 mm	45 mm	54 mm
28 weeks	52 mm	47 mm	56 mm
29 weeks	54 mm	50 mm	59 mm
30 weeks	56 mm	52 mm	61 mm
31 weeks	59 mm	54 mm	63 mm
32 weeks	61 mm	56 mm	65 mm
33 weeks	63 mm	58 mm	67 mm
34 weeks	65 mm	60 mm	69 mm
35 weeks	67 mm	62 mm	71 mm
36 weeks	68 mm	64 mm	73 mm
37 weeks	70 mm	65 mm	74 mm
38 weeks	71 mm	67 mm	76 mm
39 weeks	73 mm	68 mm	77 mm
40 weeks	74 mm	70 mm	79 mm

## Merz1988

**Name:** Merz 1988

**Author:** Merz

**Year:** 1988

**Reference:** Merz E, Goldhofer W and Timor-Tritsch E , Ultrasound in Gynecology and Obstetrics, Textbook and Atlas, Georg Thieme Verlag , 1991

**Comments:** From Merz E, Habilitationsschrift, Mainz University Woman's Hospital, 1988

GA (week)	FL (mm)	5%	95%
12 weeks	9 mm	5 mm	13 mm
13 weeks	12 mm	8 mm	16 mm
14 weeks	15 mm	11 mm	19 mm
15 weeks	18 mm	14 mm	22 mm
16 weeks	21 mm	17 mm	25 mm
17 weeks	24 mm	20 mm	28 mm
18 weeks	27 mm	22 mm	31 mm
19 weeks	30 mm	25 mm	34 mm
20 weeks	32 mm	28 mm	37 mm
21 weeks	35 mm	31 mm	40 mm
22 weeks	38 mm	34 mm	42 mm
23 weeks	41 mm	36 mm	45 mm
24 weeks	43 mm	39 mm	48 mm
25 weeks	46 mm	41 mm	51 mm
26 weeks	49 mm	44 mm	53 mm
27 weeks	51 mm	46 mm	56 mm
28 weeks	53 mm	49 mm	58 mm
29 weeks	56 mm	51 mm	61 mm
30 weeks	58 mm	53 mm	63 mm
31 weeks	60 mm	56 mm	65 mm

GA (week)	FL (mm)	5%	95%
32 weeks	63 mm	58 mm	68 mm
33 weeks	65 mm	60 mm	70 mm
34 weeks	67 mm	62 mm	72 mm
35 weeks	69 mm	64 mm	74 mm
36 weeks	71 mm	66 mm	76 mm
37 weeks	73 mm	68 mm	78 mm
38 weeks	75 mm	69 mm	80 mm
39 weeks	76 mm	71 mm	82 mm
40 weeks	78 mm	73 mm	84 mm

## HEAD CIRCUMFERENCE (HC BY GA)

### ASUM2003

**Name:** ASUM 2003

**Author:** ASUM

**Year:** 2003

**Reference:** ASUM and Campbell Westerway S , Ultrasonic fetal Measurement Standards for an Australian Population, ASUM, 2003

**Comments:** Fetal growth table generated from ASUM equations with polynomial interpretation of standard deviations

GA (week)	HC (mm)	+/- 2SD
11 weeks	54.9661 mm	14.4875 mm
12 weeks	69.5524 mm	14.7958 mm
13 weeks	83.7989 mm	15.1475 mm
14 weeks	97.7056 mm	15.5381 mm
15 weeks	111.272 mm	15.9634 mm

GA (week)	HC (mm)	+/- 2SD
16 weeks	124.5 mm	16.4189 mm
17 weeks	137.387 mm	16.9003 mm
18 weeks	149.934 mm	17.4032 mm
19 weeks	162.142 mm	17.9232 mm
20 weeks	174.01 mm	18.4561 mm
21 weeks	185.538 mm	18.9973 mm
22 weeks	196.726 mm	19.5426 mm
23 weeks	207.575 mm	20.0877 mm
24 weeks	218.084 mm	20.628 mm
25 weeks	228.252 mm	21.1593 mm
26 weeks	238.082 mm	21.6772 mm
27 weeks	247.571 mm	22.1773 mm
28 weeks	256.72 mm	22.6553 mm
29 weeks	265.53 mm	23.1068 mm
30 weeks	274 mm	23.5274 mm
31 weeks	282.13 mm	23.9128 mm
32 weeks	289.92 mm	24.2586 mm
33 weeks	297.371 mm	24.5604 mm
34 weeks	304.482 mm	24.8139 mm
35 weeks	311.252 mm	25.0148 mm
36 weeks	317.684 mm	25.1585 mm
37 weeks	323.775 mm	25.2409 mm
38 weeks	329.526 mm	25.2574 mm
39 weeks	334.938 mm	25.2039 mm
40 weeks	340.01 mm	25.0758 mm
41 weeks	344.742 mm	24.8688 mm

CFEF2000

**Name:** CFEF

**Author:** CFEF

**Year:** 2000

**Reference:** Crequat J, Duyme M and Brodaty G, Fetal growth charts by the French College of fetal ultrasonography and the Inserm U 155 , Biometry 2000, 28, pp 435-455, 2000

**Comments:** <http://cfef.org/>

GA (week)	HC (mm)	3%	10%	90%	97%
16 weeks	120.86 mm	105.8 mm	110.58 mm	131.25 mm	136.11 mm
17 weeks	134.49 mm	118.67 mm	123.78 mm	145.38 mm	150.39 mm
18 weeks	147.55 mm	131.08 mm	136.36 mm	158.92 mm	164.11 mm
19 weeks	160.29 mm	143 mm	148.53 mm	172.14 mm	177.48mm
20 weeks	172.47 mm	154.53 mm	160.21 mm	184.86 mm	190.54 mm
21 weeks	184.21 mm	165.41 mm	171.49 mm	197.12 mm	203.09 mm
22 weeks	195.74 mm	176.12 mm	182.35 mm	208.91 mm	215.15 mm
23 weeks	206.64 mm	186.32 mm	192.31 mm	220.26 mm	226.76 mm
24 weeks	217.18 mm	196.19 mm	203 mm	231.39 mm	238 mm
25 weeks	227.32 mm	205.5 mm	212.4 mm	241.91 mm	248.81 mm
26 weeks	236.72 mm	214.44 mm	221.57 mm	252 mm	259.23 mm
27 weeks	246 mm	222.87 mm	230.33 mm	261.75 mm	269.13 mm
28 weeks	254.77 mm	231 mm	238.56 mm	271 mm	278.57 mm
29 weeks	263 mm	238.4 mm	246.35 mm	279.71 mm	287.56 mm
30 weeks	270.84 mm	245.86 mm	253.74 mm	288.13 mm	296 mm
31 weeks	278.33 mm	252.54 mm	260.81 mm	296 mm	304.27 mm
32 weeks	285.29 mm	258.86 mm	267.22 mm	303.54 mm	312 mm
33 weeks	292 mm	264.62mm	273.38 mm	310.4 mm	319.1 mm
34 weeks	298.1 mm	270.14 mm	279 mm	317 mm	325.91 mm
35 weeks	303.62 mm	275.33 mm	284.23 mm	323 mm	332.16 mm
36 weeks	308.81 mm	279.79 mm	289 mm	328.75 mm	338 mm
37 weeks	313.52 mm	283.9 mm	293.32 mm	334 mm	343.34 mm
38 weeks	317.88 mm	287.63 mm	297.29 mm	338.64 mm	348.29 mm
39 weeks	321.86 mm	290.88 mm	300.76 mm	343 mm	352.67 mm
40 weeks	324 mm	293 mm	303 mm	346 mm	356 mm

## Hadlock 1984

**Name:** Hadlock 1984

**Author:** Hadlock

**Year:** 1984

**Reference:** Hadlock F.P, Deter R.L, Harrist R.B. and Park S.K, Estimating fetal age: computer-assisted analysis of multiple fetal growth parameters, Radiology, 152, pp 497-501, 1984

GA (week)	HC (cm)	+/- 1SD
12 weeks	6.79971 cm	1 cm
12.5 weeks	7.52234 cm	1 cm
13 weeks	8.2402 cm	1 cm
13.5 weeks	8.9531 cm	1 cm
14 weeks	9.66083 cm	1 cm
14.5 weeks	10.3632 cm	1 cm
15 weeks	11.0601 cm	1 cm
15.5 weeks	11.7512 cm	1 cm
16 weeks	12.4363 cm	1 cm
16.5 weeks	13.1154 cm	1 cm
17 weeks	13.7882 cm	1 cm
17.5 weeks	14.4544 cm	1 cm
18 weeks	15.114 cm	1 cm
18.5 weeks	15.7667 cm	1 cm
19 weeks	16.4123 cm	1 cm
19.5 weeks	17.0507 cm	1 cm
20 weeks	17.6816 cm	1 cm
20.5 weeks	18.3049 cm	1 cm
21 weeks	18.9203 cm	1 cm
21.5 weeks	19.5277 cm	1 cm
22 weeks	20.1269 cm	1 cm
22.5 weeks	20.7177 cm	1 cm
23 weeks	21.2998 cm	1 cm



<b>GA (week)</b>	<b>HC (cm)</b>	<b>+/- 1SD</b>
23.5 weeks	21.8732 cm	1 cm
24 weeks	22.4376 cm	1 cm
24.5 weeks	22.9929 cm	1 cm
25 weeks	23.5388 cm	1 cm
25.5 weeks	24.0751 cm	1 cm
26 weeks	24.6016 cm	1 cm
26.5 weeks	25.1183 cm	1 cm
27 weeks	25.6248 cm	1 cm
27.5 weeks	26.121 cm	1 cm
28 weeks	26.6066 cm	1 cm
28.5 weeks	27.0816 cm	1 cm
29 weeks	27.5457 cm	1 cm
29.5 weeks	27.9987 cm	1 cm
30 weeks	28.4404 cm	1 cm
30.5 weeks	28.8707 cm	1 cm
31 weeks	29.2893 cm	1 cm
31.5 weeks	29.696 cm	1 cm
32 weeks	30.0907 cm	1 cm
32.5 weeks	30.4732 cm	1 cm
33 weeks	30.8433 cm	1 cm
33.5 weeks	31.2007 cm	1 cm
34 weeks	31.5453 cm	1 cm
34.5 weeks	31.877 cm	1 cm
35 weeks	32.1955 cm	1 cm
35.5 weeks	32.5005 cm	1 cm
36 weeks	32.7921 cm	1 cm
36.5 weeks	33.0698 cm	1 cm
37 weeks	33.3336 cm	1 cm
37.5 weeks	33.5833 cm	1 cm
38 weeks	33.8186 cm	1 cm
38.5 weeks	34.0394 cm	1 cm
39 weeks	34.2455 cm	1 cm

GA (week)	HC (cm)	+/- 1SD
39.5 weeks	34.4367 cm	1 cm
40 weeks	34.6128 cm	1 cm

## Jeanty1984

**Name:** Jeanty 1984

**Author:** Jeanty

**Year:** 1984

**Reference:** Jeanty P and Romero R, Obstetrical Ultrasound, McGraw-Hill, 1984

GA (week)	HC (mm)	5%	95%
12 weeks	75 mm	51 mm	100 mm
13 weeks	88 mm	64 mm	112 mm
14 weeks	101 mm	76 mm	125 mm
15 weeks	113 mm	89 mm	138 mm
16 weeks	126 mm	101 mm	150 mm
17 weeks	138 mm	114 mm	163 mm
18 weeks	151 mm	126 mm	175 mm
19 weeks	163 mm	138 mm	187 mm
20 weeks	175 mm	150 mm	199 mm
21 weeks	187 mm	162 mm	211 mm
22 weeks	198 mm	174 mm	223 mm
23 weeks	210 mm	185 mm	234 mm
24 weeks	221 mm	196 mm	245 mm
25 weeks	232 mm	207 mm	256 mm
26 weeks	242 mm	218 mm	266 mm
27 weeks	252 mm	228 mm	277 mm
28 weeks	262 mm	238 mm	286 mm
29 weeks	271 mm	247 mm	296 mm

GA (week)	HC (mm)	5%	95%
30 weeks	281 mm	256 mm	305 mm
31 weeks	289 mm	265 mm	313 mm
32 weeks	297 mm	273 mm	322 mm
33 weeks	305 mm	281 mm	329 mm
34 weeks	312 mm	288 mm	336 mm
35 weeks	319 mm	294 mm	343 mm
36 weeks	325 mm	300 mm	349 mm
37 weeks	330 mm	306 mm	355 mm
38 weeks	335 mm	311 mm	359 mm
39 weeks	339 mm	315 mm	364 mm
40 weeks	343 mm	319 mm	367 mm

## Merz1988

**Name:** Merz 1988

**Author:** Merz

**Year:** 1988

**Reference:** Merz E, Goldhofer W and Timor-Tritsch E , Ultrasound in Gynecology and Obstetrics, Textbook and Atlas, Georg Thieme Verlag , 1991

**Comments:** From Merz E, Habilitationsschrift, Mainz University Woman's Hospital, 1988

GA (week)	HC (mm)	5%	95%
12 weeks	76 mm	63 mm	90 mm
13 weeks	90 mm	77 mm	104 mm
14 weeks	104 mm	90 mm	118 mm
15 weeks	117 mm	104 mm	132 mm
16 weeks	131 mm	117 mm	146 mm
17 weeks	144 mm	130 mm	159 mm
18 weeks	157 mm	142 mm	172 mm

GA (week)	HC (mm)	5%	95%
19 weeks	169 mm	155 mm	185 mm
20 weeks	182 mm	167 mm	197 mm
21 weeks	194 mm	179 mm	210 mm
22 weeks	205 mm	190 mm	222 mm
23 weeks	217 mm	201 mm	233 mm
24 weeks	228 mm	212 mm	245 mm
25 weeks	239 mm	223 mm	256 mm
26 weeks	249 mm	233 mm	266 mm
27 weeks	259 mm	243 mm	277 mm
28 weeks	269 mm	253 mm	287 mm
29 weeks	279 mm	262 mm	296 mm
30 weeks	288 mm	271 mm	306 mm
31 weeks	296 mm	279 mm	315 mm
32 weeks	305 mm	288 mm	323 mm
33 weeks	313 mm	296 mm	332 mm
34 weeks	321 mm	303 mm	340 mm
35 weeks	328 mm	311 mm	347 mm
36 weeks	336 mm	318 mm	355 mm
37 weeks	342 mm	324 mm	362 mm
38 weeks	349 mm	331 mm	368 mm
39 weeks	355 mm	337 mm	375 mm
40 weeks	361 mm	343 mm	381 mm

## HUMERUS LENGTH (HL BY GA)

ASUM2003

**Name:** ASUM 2003

**Author:** ASUM

**Year:** 2003

**Reference:** ASUM and Campbell Westerway S , Ultrasonic fetal Measurement Standards for an Australian Population, ASUM, 2003

**Comments:** Fetal growth table generated from ASUM equations with polynomial interpretation of standard deviations

GA (week)	HL (mm)	+/- 2SD
11 weeks	6.496 mm	2.5658 mm
12 weeks	9.4544 mm	3.03711 mm
13 weeks	12.3586 mm	3.44905 mm
14 weeks	15.208 mm	3.80497 mm
15 weeks	18.002 mm	4.10823 mm
16 weeks	20.74 mm	4.36216 mm
17 weeks	23.4214 mm	4.57012 mm
18 weeks	26.0456 mm	4.73545 mm
19 weeks	28.612 mm	4.8615 mm
20 weeks	31.12 mm	4.95163 mm
21 weeks	33.569 mm	5.00917 mm
22 weeks	35.9584 mm	5.03748 mm
23 weeks	38.2876 mm	5.0399 mm
24 weeks	40.556 mm	5.01978 mm
25 weeks	42.763 mm	4.98048 mm
26 weeks	44.908 mm	4.92533 mm
27 weeks	46.9904 mm	4.85769 mm
28 weeks	49.0096 mm	4.7809 mm
29 weeks	50.965 mm	4.69831 mm
30 weeks	52.856 mm	4.61328 mm
31 weeks	54.682 mm	4.52914 mm
32 weeks	56.4424 mm	4.44925 mm
33 weeks	58.1366 mm	4.37695 mm
34 weeks	59.764 mm	4.31559 mm
35 weeks	61.324 mm	4.26853 mm
36 weeks	62.816 mm	4.2391 mm
37 weeks	64.2394 mm	4.23066 mm

GA (week)	HL (mm)	+/- 2SD
38 weeks	65.5936 mm	4.24655 mm
39 weeks	66.878 mm	4.29012 mm
40 weeks	68.092 mm	4.36473 mm
41 weeks	69.235 mm	4.47371 mm

## Jeanty1984

**Name:** Jeanty 1984

**Author:** Jeanty

**Year:** 1984

**Reference:** Jeanty P and Romero R, Obstetrical Ultrasound, McGraw-Hill, 1984

GA (week)	HL (mm)	5%	95%
12 weeks	9 mm		
13 weeks	11 mm	6 mm	16 mm
14 weeks	14 mm	9 mm	19 mm
15 weeks	17 mm	12 mm	22 mm
16 weeks	20 mm	15 mm	25 mm
17 weeks	22 mm	18 mm	27 mm
18 weeks	25 mm	20 mm	30 mm
19 weeks	28 mm	23 mm	33 mm
20 weeks	30 mm	25 mm	35 mm
21 weeks	33 mm	28 mm	38 mm
22 weeks	35 mm	30 mm	40 mm
23 weeks	38 mm	33 mm	42 mm
24 weeks	40 mm	35 mm	45 mm
25 weeks	42 mm	37 mm	47 mm
26 weeks	44 mm	39 mm	49 mm
27 weeks	46 mm	41 mm	51 mm
28 weeks	48 mm	43 mm	53 mm

GA (week)	HL (mm)	5%	95%
29 weeks	50 mm	45 mm	55 mm
30 weeks	51 mm	47 mm	56 mm
31 weeks	53 mm	48 mm	58 mm
32 weeks	55 mm	50 mm	60 mm
33 weeks	56 mm	51 mm	61 mm
34 weeks	58 mm	53 mm	63 mm
35 weeks	59 mm	54 mm	64 mm
36 weeks	61 mm	56 mm	65 mm
37 weeks	62 mm	57 mm	67 mm
38 weeks	63 mm	59 mm	68 mm
39 weeks	65 mm	60 mm	70 mm
40 weeks	66 mm	61 mm	71 mm

## OCCIPITO-FRONTAL DIAMETER (OFD BY GA)

### ASUM2003

**Name:** ASUM 2003

**Author:** ASUM

**Year:** 2003

**Reference:** ASUM and Campbell Westerway S , Ultrasonic fetal Measurement Standards for an Australian Population, ASUM, 2003

**Comments:** Fetal growth table generated from ASUM equations with polynomial interpretation of standard deviations

GA (week)	OFD (mm)	+/- 2SD
11 weeks	18.6426 mm	2.20666 mm
12 weeks	24.0012 mm	2.36762 mm
13 weeks	29.2268 mm	2.52938 mm
14 weeks	34.3194 mm	2.6916 mm

<b>GA (week)</b>	<b>OFD (mm)</b>	<b>+/- 2SD</b>
15 weeks	39.279 mm	2.85394 mm
16 weeks	44.1056 mm	3.01606 mm
17 weeks	48.7992 mm	3.1776 mm
18 weeks	53.3598 mm	3.33824 mm
19 weeks	57.7874 mm	3.49763 mm
20 weeks	62.082 mm	3.65542 mm
21 weeks	66.2436 mm	3.81128 mm
22 weeks	70.2722 mm	3.96486
23 weeks	74.1678 mm	4.11583 mm
24 weeks	77.9304 mm	4.26383 mm
25 weeks	81.56 mm	4.40853 mm
26 weeks	85.0566 mm	4.54958 mm
27 weeks	88.4202 mm	4.68665 mm
28 weeks	91.6508 mm	4.81939 mm
29 weeks	94.7484 mm	4.94745 mm
30 weeks	97.713 mm	5.07051 mm
31 weeks	100.545 mm	5.18821 mm
32 weeks	103.243 mm	5.30021 mm
33 weeks	105.809 mm	5.40617 mm
34 weeks	108.241 mm	5.50575 mm
35 weeks	110.541 mm	5.59861 mm
36 weeks	112.708 mm	5.68441 mm
37 weeks	114.741 mm	5.76279 mm
38 weeks	116.642 mm	5.83343 mm
39 weeks	118.409 mm	5.89598 mm
40 weeks	120.044 mm	5.95009 mm
41 weeks	121.546 mm	5.99543 mm



## TRANS-ABDOMINAL DIAMETER (TAD BY GA)

CFEF2000

**Name:** CFEF

**Author:** CFEF

**Year:** 2000

**Reference:** Crequat J, Duyme M and Brodaty G, Fetal growth charts by the French College of fetal ultrasonography and the Inserm U 155 , Biometry 2000, 28, pp 435-455, 2000

**Comments:** <http://cfef.org/>

GA (week)	TAD (mm)	3%	10%	90%	97%
11 weeks	13.5 mm	9.68 mm	11 mm	16 mm	17.25 mm
12 weeks	17 mm	12.68 mm	14 mm	20 mm	21.46 mm
13 weeks	20.56 mm	15.6 mm	17.25 mm	24 mm	25.51 mm
14 weeks	24 mm	18.69 mm	20.41 mm	27.84 mm	29.56 mm
15 weeks	27.69 mm	21.76 mm	23.64 mm	31.74 mm	33.61 mm
16 weeks	31.21 mm	25 mm	27 mm	35.53 mm	37.48 mm
17 weeks	34.7 mm	28.23 mm	30.34 mm	39.21 mm	41.39 mm
18 weeks	38.31 mm	31.54 mm	33.64 mm	42.89 mm	45.14 mm
19 weeks	41.69 mm	34.78 mm	37 mm	46.42 mm	48.59 mm
20 weeks	45.21 mm	38.16 mm	40.26 mm	50 mm	52.2 mm
21 weeks	48.34 mm	41.14 mm	43.46 mm	53.22 mm	55.63 mm
22 weeks	51.57 mm	44.21 mm	46.61 mm	56.75 mm	59.08 mm
23 weeks	54.72 mm	47 mm	49.47 mm	60 mm	62.46 mm
24 weeks	57.88 mm	49.77 mm	52.39 mm	63.43 mm	66 mm
25 weeks	61 mm	52.54 mm	55.18 mm	66.74 mm	69.44 mm
26 weeks	64 mm	55.17 mm	58 mm	70.12 mm	72.89 mm
27 weeks	67.11 mm	57.72 mm	60.73 mm	73.42 mm	76.42 mm
28 weeks	70.27 mm	60.43 mm	63.58 mm	76.8 mm	79.87 mm
29 weeks	73.27 mm	63.13 mm	66.36 mm	80.17 mm	83.33 mm

GA (week)	TAD (mm)	3%	10%	90%	97%
30 weeks	76.17 mm	65.8 mm	69.17 mm	83.45 mm	86.75 mm
31 weeks	79.25 mm	68.35 mm	71.88 mm	86.68 mm	90.13 mm
32 weeks	82.1 mm	70.9 mm	74.43 mm	89.76 mm	93.36 mm
33 weeks	84.78 mm	73.08 mm	76.75 mm	92.89 mm	96.64 mm
34 weeks	87.55 mm	75.25 mm	79.08 mm	95.89 mm	99.86 mm
35 weeks	90 mm	77 mm	81.1 mm	99 mm	103 mm
36 weeks	92.36 mm	78.48 mm	82.9 mm	102 mm	106.31 mm
37 weeks	94.81 mm	79.79 mm	84.6 mm	105 mm	109.67 mm
38 weeks	97 mm	80.92 mm	86.1 mm	108.19 mm	113.29 mm
39 weeks	99.33 mm	81.85 mm	87.41 mm	111.34 mm	117 mm
40 weeks	101.64 mm	82.58 mm	88.59 mm	114.52 mm	120.7 mm
41 weeks	103 mm	82.8 mm	89.2 mm	117 mm	123 mm

## TIBIA (TIB BY GA)

### Jeanty1984

**Name:** Jeanty 1984

**Author:** Jeanty

**Year:** 1984

**Reference:** Jeanty P and Romero R, Obstetrical Ultrasound, McGraw-Hill, 1984

GA (week)	TIB (mm)	5%	95%
12 weeks	7 mm		
13 weeks	10 mm		
14 weeks	12 mm	7 mm	17 mm
15 weeks	15 mm	9 mm	20 mm
16 weeks	17 mm	12 mm	22 mm
17 weeks	20 mm	15 mm	25 mm

GA (week)	TIB (mm)	5%	95%
18 weeks	22 mm	17 mm	27 mm
19 weeks	25 mm	20 mm	30 mm
20 weeks	27 mm	22 mm	33 mm
21 weeks	30 mm	25 mm	35 mm
22 weeks	32 mm	27 mm	38 mm
23 weeks	35 mm	30 mm	40 mm
24 weeks	37 mm	32 mm	42 mm
25 weeks	40 mm	34 mm	45 mm
26 weeks	42 mm	37 mm	47 mm
27 weeks	44 mm	39 mm	49 mm
28 weeks	46 mm	41 mm	51 mm
29 weeks	48 mm	43 mm	53 mm
30 weeks	50 mm	45 mm	55 mm
31 weeks	52 mm	47 mm	57 mm
32 weeks	54 mm	48 mm	59 mm
33 weeks	55 mm	50 mm	60 mm
34 weeks	57 mm	52 mm	62 mm
35 weeks	58 mm	53 mm	64 mm
36 weeks	60 mm	55 mm	65 mm
37 weeks	61 mm	56 mm	67 mm
38 weeks	63 mm	58 mm	68 mm
39 weeks	64 mm	59 mm	69 mm
40 weeks	66 mm	61 mm	71 mm

## ULNA (ULNA BY GA)

Jeanty1984

**Name:** Jeanty 1984

**Author:** Jeanty

**Year:** 1984

**Reference:** Jeanty P and Romero R, Obstetrical Ultrasound, McGraw-Hill, 1984

<b>GA (week)</b>	<b>ULNA (mm)</b>	<b>5%</b>	<b>95%</b>
12 weeks	7 mm	3 mm	11 mm
13 weeks	10 mm	5 mm	15 mm
14 weeks	13 mm	8 mm	18 mm
15 weeks	16 mm	11 mm	21 mm
16 weeks	18 mm	13 mm	23 mm
17 weeks	21 mm	16 mm	26 mm
18 weeks	24 mm	19 mm	29 mm
19 weeks	26 mm	21 mm	31 mm
20 weeks	29 mm	24 mm	34 mm
21 weeks	31 mm	26 mm	36 mm
22 weeks	33 mm	28 mm	38 mm
23 weeks	36 mm	31 mm	41 mm
24 weeks	38 mm	33 mm	43 mm
25 weeks	40 mm	35 mm	45 mm
26 weeks	42 mm	37 mm	47 mm
27 weeks	44 mm	39 mm	49 mm
28 weeks	46 mm	41 mm	51 mm
29 weeks	48 mm	43 mm	53 mm
30 weeks	49 mm	44 mm	54 mm
31 weeks	51 mm	46 mm	56 mm
32 weeks	53 mm	48 mm	58 mm
33 weeks	54 mm	49 mm	59 mm
34 weeks	56 mm	51 mm	61 mm
35 weeks	57 mm	52 mm	62 mm
36 weeks	58 mm	53 mm	63 mm
37 weeks	60 mm	55 mm	65 mm
38 weeks	61 mm	56 mm	66 mm
39 weeks	62 mm	57 mm	67 mm

GA (week)	ULNA (mm)	5%	95%
40 weeks	63 mm	58 mm	68 mm

## Gestational Age (GA) Equations and Tables

### ABDOMINAL CIRCUMFERENCE (GA BY AC)

#### ASUM2003

**Name:** ASUM 2003

**Author:** ASUM

**Year:** 2003

**Reference:** ASUM and Campbell Westerway S , Ultrasonic fetal Measurement Standards for an Australian Population, ASUM, 2003

Input parameter: AC (mm)

Min limit: 52

Max limit: 367

Output: GA (week)

Equation:

$$0.0000367 * \_AC * \_AC + 0.07715 * \_AC + 7.192$$

#### CFEF2000

**Name:** CFEF

**Author:** CFEF

**Year:** 2000

**Reference:** Crequat J, Duyme M and Brodaty G, Fetal growth charts by the French College of fetal ultrasonography and the Inserm U 155 , Biometry 2000, 28, pp 435-455, 2000

**Comments:** <http://cfef.org/>

AC (mm)	GA (week)
95 mm	15 weeks
106.4 mm	16 weeks
118 mm	17 weeks
129.2 mm	18 weeks
140.4 mm	19 weeks
151.4 mm	20 weeks
162.3 mm	21 weeks
173 mm	22 weeks
183.6 mm	23 weeks
194 mm	24 weeks
204.4 mm	25 weeks
214.5 mm	26 weeks
224.5 mm	27 weeks
234.4 mm	28 weeks
244 mm	29 weeks
253.6 mm	30 weeks
263 mm	31 weeks
272.2 mm	32 weeks
281.2 mm	33 weeks
290.2 mm	34 weeks
298.8 mm	35 weeks
307.4 mm	36 weeks
316 mm	37 weeks
324.7 mm	38 weeks
332.4 mm	39 weeks
339 mm	40 weeks

## Hadlock 1984

**Name:** Hadlock 1984

**Author:** Hadlock

**Year:** 1984

**Reference:** Hadlock F.P, Deter R.L, Harrist R.B. and Park S.K, Estimating fetal age: computer-assisted analysis of multiple fetal growth parameters, Radiology, 152, pp 497-501, 1984

AC (cm)	GA (week)	+/- 2SD
4.6 cm	11.68 weeks	1.66 weeks
5.3 cm	12.232 weeks	1.66 weeks
6 cm	12.7876 weeks	1.66 weeks
6.7 cm	13.3467 weeks	1.66 weeks
7.3 cm	13.8287 weeks	1.66 weeks
8 cm	14.3944 weeks	1.66 weeks
8.6 cm	14.8821 weeks	1.66 weeks
9.3 cm	15.4543 weeks	1.66 weeks
9.9 cm	15.9475 weeks	1.66 weeks
10.6 cm	16.5263 weeks	1.66 weeks
11.2 cm	17.0252 weeks	1.66 weeks
11.9 cm	17.6105 weeks	1.66 weeks
12.5 cm	18.115 weeks	2.06 weeks
13.1 cm	18.6221 weeks	2.06 weeks
13.7 cm	19.1318 weeks	2.06 weeks
14.4 cm	19.7297 weeks	2.06 weeks
15 cm	20.245 weeks	2.06 weeks
15.6 cm	20.7629 weeks	2.06 weeks
16.2 cm	21.2834 weeks	2.06 weeks
16.8 cm	21.8065 weeks	2.06 weeks
17.4 cm	22.3321 weeks	2.06 weeks
17.9 cm	22.7722 weeks	2.06 weeks
18.5 cm	23.3026 weeks	2.06 weeks

AC (cm)	GA (week)	+/- 2SD
19.1 cm	23.8356 weeks	2.06 weeks
19.7 cm	24.3712 weeks	2.18 weeks
20.2 cm	24.8195 weeks	2.18 weeks
20.8 cm	25.3599 weeks	2.18 weeks
21.3 cm	25.8122 weeks	2.18 weeks
21.9 cm	26.3573 weeks	2.18 weeks
22.4 cm	26.8135 weeks	2.18 weeks
23 cm	27.3634 weeks	2.18 weeks
23.5 cm	27.8236 weeks	2.18 weeks
24 cm	28.2856 weeks	2.18 weeks
24.6 cm	28.8424 weeks	2.18 weeks
25.1 cm	29.3083 weeks	2.18 weeks
25.6 cm	29.7761 weeks	2.18 weeks
26.1 cm	30.2457 weeks	2.96 weeks
26.6 cm	30.717 weeks	2.96 weeks
27.1 cm	31.1902 weeks	2.96 weeks
27.6 cm	31.6651 weeks	2.96 weeks
28.1 cm	32.1419 weeks	2.96 weeks
28.6 cm	32.6205 weeks	2.96 weeks
29.1 cm	33.1008 weeks	2.96 weeks
29.5 cm	33.4864 weeks	2.96 weeks
30 cm	33.97 weeks	2.96 weeks
30.5 cm	34.4554 weeks	2.96 weeks
30.9 cm	34.845 weeks	2.96 weeks
31.4 cm	35.3337 weeks	2.96 weeks
31.8 cm	35.7259 weeks	3.04 weeks
32.3 cm	36.2177 weeks	3.04 weeks
32.7 cm	36.6125 weeks	3.04 weeks
33.2 cm	37.1077 weeks	3.04 weeks
33.6 cm	37.5051 weeks	3.04 weeks
34 cm	37.9036 weeks	3.04 weeks
34.4 cm	38.3033 weeks	3.04 weeks



AC (cm)	GA (week)	+/- 2SD
34.8 cm	38.7041 weeks	3.04 weeks
35.3 cm	39.2068 weeks	3.04 weeks

## Merz1988

**Name:** Merz 1988

**Author:** Merz

**Year:** 1988

**Reference:** Merz E, Goldhofer W and Timor-Tritsch E , Ultrasound in Gynecology and Obstetrics, Textbook and Atlas, Georg Thieme Verlag , 1991

**Comments:** From Merz E, Habilitationsschrift, Mainz University Woman's Hospital, 1988

AC (mm)	GA (wd)	5%	95%
56 mm	12w1d	10w6d	13w2d
58 mm	12w2d	11w1d	13w4d
60 mm	12w4d	11w2d	13w5d
62 mm	12w5d	11w4d	13w6d
64 mm	12w6d	11w5d	14w1d
66 mm	13w1d	11w6d	14w2d
68 mm	13w2d	12w0d	14w4d
70 mm	13w4d	12w1d	14w5d
72 mm	13w4d	12w3d	14w6d
74 mm	13w6d	12w4d	15w1d
76 mm	14w0d	12w6d	15w2d
78 mm	14w1d	12w6d	15w4d
80 mm	14w3d	13w1d	15w5d
82 mm	14w4d	13w2d	15w6d
84 mm	14w6d	13w4d	16w1d
86 mm	15w0d	13w5d	16w2d

AC (mm)	GA (wd)	5%	95%
88 mm	15w1d	13w6d	16w4d
90 mm	15w3d	14w0d	16w5d
92 mm	15w4d	14w1d	16w6d
94 mm	15w5d	14w3d	17w1d
96 mm	15w6d	14w4d	17w2d
98 mm	16w1d	14w6d	17w4d
100 mm	16w2d	14w6d	17w5d
102 mm	16w4d	15w1d	17w6d
104 mm	16w5d	15w2d	18w1d
106 mm	16w6d	15w4d	18w2d
108 mm	17w1d	15w5d	18w3d
110 mm	17w2d	15w6d	18w4d
112 mm	17w3d	16w0d	18w6d
114 mm	17w4d	16w1d	19w0d
116 mm	17w6d	16w3d	19w1d
118 mm	18w0d	16w4d	19w3d
120 mm	18w1d	16w6d	19w4d
122 mm	18w3d	17w0d	19w6d
124 mm	18w4d	17w1d	20w0d
126 mm	18w6d	17w2d	20w1d
128 mm	19w0d	17w4d	20w3d
130 mm	19w1d	17w5d	20w4d
132 mm	19w2d	17w6d	20w6d
134 mm	19w4d	18w0d	21w0d
136 mm	19w5d	18w1d	21w1d
138 mm	19w6d	18w3d	21w3d
140 mm	20w1d	18w4d	21w4d
142 mm	20w2d	18w6d	21w6d
144 mm	20w4d	19w0d	22w0d
146 mm	20w5d	19w1d	22w1d
148 mm	20w6d	19w2d	22w3d
150 mm	21w1d	19w4d	22w4d

AC (mm)	GA (wd)	5%	95%
152 mm	21w1d	19w5d	22w6d
154 mm	21w3d	19w6d	23w0d
156 mm	21w4d	20w1d	23w1d
158 mm	21w6d	20w1d	23w3d
160 mm	22w0d	20w3d	23w4d
162 mm	22w1d	20w4d	23w6d
164 mm	22w3d	20w6d	24w0d
166 mm	22w4d	21w0d	24w1d
168 mm	22w6d	21w1d	24w3d
170 mm	23w0d	21w2d	24w4d
172 mm	23w1d	21w4d	24w6d
174 mm	23w2d	21w5d	25w0d
176 mm	23w4d	21w6d	25w1d
178 mm	23w5d	22w1d	25w3d
180 mm	23w6d	22w1d	25w4d
182 mm	24w1d	22w3d	25w6d
184 mm	24w2d	22w4d	26w0d
186 mm	24w4d	22w6d	26w1d
188 mm	24w5d	23w0d	26w3d
190 mm	24w6d	23w1d	26w4d
192 mm	25w0d	23w2d	26w6d
194 mm	25w1d	23w4d	27w0d
196 mm	25w3d	23w5d	27w1d
198 mm	25w4d	23w6d	27w3d
200 mm	25w6d	24w1d	27w4d
202 mm	26w0d	24w2d	27w6d
204 mm	26w1d	24w3d	27w6d
206 mm	26w3d	24w4d	28w1d
208 mm	26w4d	24w6d	28w2d
210 mm	26w6d	25w0d	28w4d
212 mm	27w0d	25w1d	28w5d
214 mm	27w1d	25w2d	28w6d

AC (mm)	GA (wd)	5%	95%
216 mm	27w2d	25w4d	29w1d
218 mm	27w4d	25w5d	29w2d
220 mm	27w5d	25w6d	29w4d
222 mm	27w6d	26w1d	29w5d
224 mm	28w1d	26w2d	29w6d
226 mm	28w2d	26w3d	30w1d
228 mm	28w4d	26w4d	30w2d
230 mm	28w5d	26w6d	30w4d
232 mm	28w6d	27w0d	30w5d
234 mm	29w0d	27w1d	30w6d
236 mm	29w1d	27w3d	31w1d
238 mm	29w3d	27w4d	31w2d
240 mm	29w4d	27w5d	31w4d
242 mm	29w6d	27w6d	31w5d
244 mm	30w0d	28w1d	31w6d
246 mm	30w1d	28w2d	32w1d
248 mm	30w3d	28w3d	32w2d
250 mm	30w4d	28w4d	32w4d
252 mm	30w6d	28w6d	32w5d
254 mm	30w6d	29w0d	32w6d
256 mm	31w1d	29w1d	33w1d
258 mm	31w2d	29w3d	33w2d
260 mm	31w4d	29w4d	33w4d
262 mm	31w5d	29w5d	33w5d
264 mm	31w6d	29w6d	33w6d
266 mm	32w1d	30w1d	34w1d
268 mm	32w2d	30w2d	34w2d
270 mm	32w4d	30w4d	34w4d
272 mm	32w5d	30w4d	34w5d
274 mm	32w6d	30w6d	34w6d
276 mm	33w0d	31w0d	35w1d
278 mm	33w1d	31w1d	35w2d

AC (mm)	GA (wd)	5%	95%
280 mm	33w3d	31w3d	35w4d
282 mm	33w4d	31w4d	35w5d
284 mm	33w6d	31w5d	35w6d
286 mm	34w0d	31w6d	36w1d
288 mm	34w1d	32w1d	36w2d
290 mm	34w3d	32w2d	36w4d
292 mm	34w4d	32w4d	36w5d
294 mm	34w5d	32w4d	36w6d
296 mm	34w6d	32w6d	37w1d
298 mm	35w1d	33w0d	37w1d
300 mm	35w2d	33w1d	37w3d
302 mm	35w4d	33w3d	37w4d
304 mm	35w5d	33w4d	37w6d
306 mm	35w6d	33w5d	38w0d
308 mm	36w1d	33w6d	38w1d
310 mm	36w2d	34w1d	38w3d
312 mm	36w4d	34w2d	38w4d
314 mm	36w4d	34w4d	38w6d
316 mm	36w6d	34w4d	39w0d
318 mm	37w0d	34w6d	39w1d
320 mm	37w1d	35w0d	39w3d
322 mm	37w3d	35w1d	39w4d
324 mm	37w4d	35w3d	39w6d
326 mm	37w6d	35w4d	40w0d
328 mm	38w0d	35w5d	40w1d
330 mm	38w1d	35w6d	40w3d
332 mm	38w3d	36w1d	40w4d
334 mm	38w4d	36w2d	40w6d
336 mm	38w5d	36w4d	41w0d
338 mm	38w6d	36w5d	41w1d
340 mm	39w1d	36w6d	41w3d
342 mm	39w2d	37w0d	41w4d

AC (mm)	GA (wd)	5%	95%
344 mm	39w4d	37w1d	41w6d
346 mm	39w5d	37w3d	42w0d
348 mm	39w6d	37w4d	42w1d

## Hansmann1986

**Name:** Hansmann 1986

**Author:** Hansmann

**Year:** 1986

**Reference:** Hansmann, Hackeloer, Staudach and Wittman, Ultrasound Diagnosis in Obstetrics and Gynecology, Springer-Verlag, New York, 1986

AC (cm)	GA (week)
5.3 cm	12 weeks
6.3 cm	13 weeks
7.5 cm	14 weeks
8.5 cm	15 weeks
9.7 cm	16 weeks
10.7 cm	17 weeks
11.6 cm	18 weeks
12.6 cm	19 weeks
13.5 cm	20 weeks
14.5 cm	21 weeks
15.5 cm	22 weeks
16.5 cm	23 weeks
17.3 cm	24 weeks
18.3 cm	25 weeks
19.1 cm	26 weeks
20.2 cm	27 weeks
21.1 cm	28 weeks

AC (cm)	GA (week)
22.2 cm	29 weeks
23 cm	30 weeks
24 cm	31 weeks
24.9 cm	32 weeks
25.8 cm	33 weeks
26.8 cm	34 weeks
27.7 cm	35 weeks
28.7 cm	36 weeks
29.6 cm	37 weeks
30.6 cm	38 weeks
31.5 cm	39 weeks
32 cm	40 weeks

## BIPARIETAL DIAMETER (GA BY BPD)

### ASUM2003

**Name:** ASUM 2003

**Author:** ASUM

**Year:** 2003

**Reference:** ASUM and Campbell Westerway S , Ultrasonic fetal Measurement Standards for an Australian Population, ASUM, 2003

Input parameter: BPD (mm)

Min limit: 16

Max limit: 98

Output: GA (week)

Equation:

$$0.397 * \_BPD - 0.00306 * \_BPD^2 + 0.00002788 * \_BPD^3 + 4.933$$

CFEF2000

**Name:** CFEF

**Author:** CFEF

**Year:** 2000

**Reference:** Crequat J, Duyme M and Brodaty G, Fetal growth charts by the French College of fetal ultrasonography and the Inserm U 155 , Biometry 2000, 28, pp 435-455, 2000

**Comments:** <http://cfef.org/>

BPD (mm)	GA (week)
15.36 mm	11 weeks
19.4 mm	12 weeks
23.3 mm	13 weeks
27.14 mm	14 weeks
30.89 mm	15 weeks
34.53 mm	16 weeks
38.12 mm	17 weeks
41.58 mm	18 weeks
45 mm	19 weeks
48.22 mm	20 weeks
51.43 mm	21 weeks
54.53 mm	22 weeks
57.51 mm	23 weeks
60.42 mm	24 weeks
63.25 mm	25 weeks
65.94 mm	26 weeks
68.55 mm	27 weeks
71.03 mm	28 weeks
73.5 mm	29 weeks



BPD (mm)	GA (week)
75.8 mm	30 weeks
78 mm	31 weeks
80.16 mm	32 weeks
82.14 mm	33 weeks
84.07 mm	34 weeks
85.9 mm	35 weeks
87.61 mm	36 weeks
89.24 mm	37 weeks
90.7 mm	38 weeks
92.1 mm	39 weeks
93.45 mm	40 weeks
94 mm	41 weeks

## Hadlock1984

**Name:** Hadlock 1984

**Author:** Hadlock

**Year:** 1984

**Reference:** Hadlock F.P, Deter R.L, Harrist R.B. and Park S.K, Estimating fetal age: computer-assisted analysis of multiple fetal growth parameters, Radiology, 152, pp 497-501, 1984

BPD (cm)	GA (week)	+/- 2SD
1.7 cm	12.5438 weeks	1.19 weeks
1.9 cm	12.9608 weeks	1.19 weeks
2.1 cm	13.3913 weeks	1.19 weeks
2.3 cm	13.8352 weeks	1.19 weeks
2.5 cm	14.2925 weeks	1.19 weeks
2.7 cm	14.7632 weeks	1.19 weeks
2.9 cm	15.2473 weeks	1.19 weeks
3.1 cm	15.7448 weeks	1.19 weeks

<b>BPD (cm)</b>	<b>GA (week)</b>	<b>+/- 2SD</b>
3.2 cm	15.9986 weeks	1.19 weeks
3.4 cm	16.5163 weeks	1.19 weeks
3.6 cm	17.0473 weeks	1.19 weeks
3.8 cm	17.5917 weeks	1.19 weeks
3.9 cm	17.869 weeks	1.73 weeks
4.1 cm	18.4336 weeks	1.73 weeks
4.3 cm	19.0115 weeks	1.73 weeks
4.5 cm	19.6029 weeks	1.73 weeks
4.6 cm	19.9036 weeks	1.73 weeks
4.8 cm	20.5151 weeks	1.73 weeks
5 cm	21.14 weeks	1.73 weeks
5.1 cm	21.4575 weeks	1.73 weeks
5.3 cm	22.1025 weeks	1.73 weeks
5.5 cm	22.7609 weeks	1.73 weeks
5.6 cm	23.0951 weeks	1.73 weeks
5.8 cm	23.7737 weeks	1.73 weeks
5.9 cm	24.118 weeks	2.18 weeks
6.1 cm	24.8166 weeks	2.18 weeks
6.2 cm	25.1709 weeks	2.18 weeks
6.4 cm	25.8897 weeks	2.18 weeks
6.5 cm	26.2541 weeks	2.18 weeks
6.7 cm	26.993 weeks	2.18 weeks
6.8 cm	27.3674 weeks	2.18 weeks
6.9 cm	27.7452 weeks	2.18 weeks
7.1 cm	28.5109 weeks	2.18 weeks
7.2 cm	28.8988 weeks	2.18 weeks
7.3 cm	29.29 weeks	2.18 weeks
7.5 cm	30.0825 weeks	2.18 weeks
7.6 cm	30.4838 weeks	3.08 weeks
7.7 cm	30.8884 weeks	3.08 weeks
7.8 cm	31.2964 weeks	3.08 weeks
7.9 cm	31.7077 weeks	3.08 weeks

BPD (cm)	GA (week)	+/- 2SD
8.1 cm	32.5404 weeks	3.08 weeks
8.2 cm	32.9618 weeks	3.08 weeks
8.3 cm	33.3866 weeks	3.08 weeks
8.4 cm	33.8147 weeks	3.08 weeks
8.5 cm	34.2461 weeks	3.08 weeks
8.6 cm	34.6809 weeks	3.08 weeks
8.7 cm	35.119 weeks	3.08 weeks
8.8 cm	35.5605 weeks	3.08 weeks
8.9 cm	36.0054 weeks	3.2 weeks
9 cm	36.4536 weeks	3.2 weeks
9.1 cm	36.9052 weeks	3.2 weeks
9.2 cm	37.3601 weeks	3.2 weeks
9.3 cm	37.8183 weeks	3.2 weeks
9.4 cm	38.2799 weeks	3.2 weeks

## Jeanty1984

**Name:** Jeanty 1984

**Author:** Jeanty

**Year:** 1984

**Reference:** Jeanty P and Romero R, Obstetrical Ultrasound, McGraw-Hill, 1984

BPD (mm)	GA (wd)	5%	95%
10 mm	9w1d	6w4d	11w6d
11 mm	9w4d	6w6d	12w1d
12 mm	9w5d	7w0d	12w3d
13 mm	10w0d	7w2d	12w5d
14 mm	10w2d	7w4d	12w6d
15 mm	10w4d	7w6d	13w1d
16 mm	10w6d	8w1d	13w3d

BPD (mm)	GA (wd)	5%	95%
17 mm	11w1d	8w3d	13w5d
18 mm	11w2d	8w4d	14w0d
19 mm	11w4d	8w6d	14w1d
20 mm	11w6d	9w1d	14w4d
21 mm	12w1d	9w3d	14w6d
22 mm	12w3d	9w5d	15w0d
23 mm	12w4d	9w6d	15w2d
24 mm	12w6d	10w1d	15w4d
25 mm	13w1d	10w4d	15w6d
26 mm	13w3d	10w5d	16w1d
27 mm	13w5d	11w0d	16w3d
28 mm	14w0d	11w2d	16w4d
29 mm	14w1d	11w4d	16w6d
30 mm	14w4d	11w6d	17w1d
31 mm	14w6d	12w1d	17w3d
32 mm	15w1d	12w2d	17w5d
33 mm	15w2d	12w4d	18w0d
34 mm	15w4d	12w6d	18w2d
35 mm	15w6d	13w1d	18w4d
36 mm	16w1d	13w4d	18w6d
37 mm	16w3d	13w5d	19w1d
38 mm	16w5d	14w0d	19w3d
39 mm	17w0d	14w2d	19w5d
40 mm	17w2d	14w4d	19w6d
41 mm	17w4d	14w6d	20w1d
42 mm	17w6d	15w1d	20w4d
43 mm	18w1d	15w3d	20w6d
44 mm	18w3d	15w5d	21w1d
45 mm	18w5d	16w0d	21w3d
46 mm	19w0d	16w2d	21w5d
47 mm	19w2d	16w4d	22w0d
48 mm	19w4d	16w6d	22w2d

BPD (mm)	GA (wd)	5%	95%
49 mm	19w6d	17w1d	22w4d
50 mm	20w2d	17w4d	22w6d
51 mm	20w4d	17w6d	23w1d
52 mm	20w6d	18w1d	23w4d
53 mm	21w1d	18w4d	23w6d
54 mm	21w4d	18w6d	24w1d
55 mm	21w6d	19w1d	24w4d
56 mm	22w1d	19w4d	24w6d
57 mm	22w4d	19w6d	25w1d
58 mm	22w6d	20w1d	25w4d
59 mm	23w1d	20w4d	25w6d
60 mm	23w4d	20w6d	26w1d
61 mm	23w6d	21w1d	26w4d
62 mm	24w1d	21w4d	26w6d
63 mm	24w4d	21w6d	27w1d
64 mm	24w6d	22w1d	27w4d
65 mm	25w2d	22w4d	27w6d
66 mm	25w4d	22w6d	28w2d
67 mm	26w0d	23w2d	28w4d
68 mm	26w3d	23w5d	29w0d
69 mm	26w5d	24w0d	29w3d
70 mm	27w1d	24w3d	29w6d
71 mm	27w4d	24w6d	30w1d
72 mm	27w6d	25w1d	30w4d
73 mm	28w2d	25w4d	30w6d
74 mm	28w5d	26w0d	31w2d
75 mm	29w1d	26w3d	31w5d
76 mm	29w4d	26w6d	32w1d
77 mm	29w6d	27w1d	32w4d
78 mm	30w2d	27w4d	33w0d
79 mm	30w5d	28w0d	33w3d
80 mm	31w1d	28w4d	33w6d

BPD (mm)	GA (wd)	5%	95%
81 mm	31w4d	28w6d	34w2d
82 mm	32w0d	29w2d	34w5d
83 mm	32w4d	29w6d	35w1d
84 mm	32w6d	30w1d	35w4d
85 mm	33w3d	30w5d	36w0d
86 mm	33w6d	31w1d	36w4d
87 mm	34w2d	31w4d	37w0d
88 mm	34w6d	32w1d	37w3d
89 mm	35w2d	32w4d	37w6d
90 mm	35w5d	33w0d	38w3d
91 mm	36w1d	33w4d	38w6d
92 mm	36w5d	34w0d	39w3d
93 mm	37w1d	34w4d	39w6d
94 mm	37w5d	35w0d	40w3d
95 mm	38w2d	35w4d	40w6d

## Merz1988

**Name:** Merz 1984

**Author:** Merz

**Year:** 1988

**Reference:** Merz E, Goldhofer W and Timor-Tritsch E , Ultrasound in Gynecology and Obstetrics, Textbook and Atlas, Georg Thieme Verlag , 1991

**Comments:** From Merz E, Habilitationsschrift, Mainz University Woman's Hospital, 1988

BPD (mm)	GA (wd)	5%	95%
21 mm	12w1d	10w5d	13w5d
22 mm	12w3d	10w6d	13w6d
23 mm	12w5d	11w1d	14w1d

<b>BPD (mm)</b>	<b>GA (wd)</b>	<b>5%</b>	<b>95%</b>
24 mm	13w0d	11w4d	14w4d
25 mm	13w1d	11w5d	14w5d
26 mm	13w4d	12w0d	15w0d
27 mm	13w6d	12w1d	15w3d
28 mm	14w1d	12w4d	15w5d
29 mm	14w2d	12w5d	15w6d
30 mm	14w4d	13w0d	16w1d
31 mm	14w6d	13w2d	16w4d
32 mm	15w1d	13w4d	16w6d
33 mm	15w3d	13w6d	17w0d
34 mm	15w5d	14w0d	17w3d
35 mm	16w0d	14w2d	17w5d
36 mm	16w2d	14w4d	18w0d
37 mm	16w4d	14w6d	18w1d
38 mm	16w6d	15w1d	18w4d
39 mm	17w1d	15w3d	18w6d
40 mm	17w3d	15w5d	19w1d
41 mm	17w5d	15w6d	19w4d
42 mm	18w0d	16w1d	19w6d
43 mm	18w2d	16w4d	20w1d
44 mm	18w4d	16w6d	20w3d
45 mm	18w6d	17w1d	20w5d
46 mm	19w1d	17w3d	21w0d
47 mm	19w3d	17w4d	21w1d
48 mm	19w5d	17w6d	21w4d
49 mm	20w0d	18w1d	21w6d
50 mm	20w3d	18w4d	22w1d
51 mm	20w5d	18w6d	22w4d
52 mm	21w0d	19w1d	22w6d
53 mm	21w2d	19w3d	23w1d
54 mm	21w4d	19w5d	23w4d
55 mm	21w6d	20w0d	23w6d

BPD (mm)	GA (wd)	5%	95%
56 mm	22w1d	20w2d	24w1d
57 mm	22w4d	20w4d	24w3d
58 mm	22w6d	20w6d	24w5d
59 mm	23w1d	21w1d	25w1d
60 mm	23w4d	21w4d	25w4d
61 mm	23w6d	21w6d	25w6d
62 mm	24w1d	22w1d	26w1d
63 mm	24w4d	22w4d	26w4d
64 mm	24w6d	22w6d	26w6d
65 mm	25w1d	23w1d	27w1d
66 mm	25w4d	23w4d	27w4d
67 mm	25w6d	23w6d	27w6d
68 mm	26w1d	24w1d	28w2d
69 mm	26w4d	24w3d	28w4d
70 mm	26w6d	24w5d	28w6d
71 mm	27w1d	25w1d	29w2d
72 mm	27w4d	25w4d	29w5d
73 mm	27w6d	25w6d	30w0d
74 mm	28w2d	26w1d	30w3d
75 mm	28w4d	26w4d	30w5d
76 mm	29w0d	26w6d	31w1d
77 mm	29w3d	27w1d	31w4d
78 mm	29w6d	27w4d	32w0d
79 mm	30w1d	27w6d	32w2d
80 mm	30w4d	28w2d	32w5d
81 mm	30w6d	28w5d	33w1d
82 mm	31w2d	29w1d	33w4d
83 mm	31w5d	29w4d	33w6d
84 mm	32w1d	29w6d	34w2d
85 mm	32w4d	30w2d	34w5d
86 mm	32w6d	30w5d	35w1d
87 mm	33w2d	31w0d	35w4d



BPD (mm)	GA (wd)	5%	95%
88 mm	33w6d	31w4d	36w1d
89 mm	34w1d	31w6d	36w4d
90 mm	34w4d	32w2d	36w6d
91 mm	35w1d	32w6d	37w3d
92 mm	35w4d	33w1d	37w6d
93 mm	35w6d	33w4d	38w1d
94 mm	36w3d	34w0d	38w6d
95 mm	36w6d	34w4d	39w2d
96 mm	37w2d	34w6d	39w5d
97 mm	37w6d	35w3d	40w1d
98 mm	38w2d	35w6d	40w5d
99 mm	38w6d	36w3d	41w1d
100 mm	39w2d	36w6d	41w6d
101 mm	39w6d	37w2d	42w2d
102 mm	40w2d	37w6d	42w6d

## Hansmann 1986

**Name:** Hansmann 1986

**Author:** Hansmann

**Year:** 1986

**Reference:** Hansmann, Hackeloer, Staudach and Wittman, Ultrasound Diagnosis in Obstetrics and Gynecology, Springer-Verlag, New York, 1986

BPD (mm)	GA (day)	5%	95%
29 mm	94 days	86 days	101 days
30 mm	96 days	89 days	103 days
31 mm	98 days	90 days	106 days
32 mm	100 days	93 days	108 days
33 mm	102 days	94 days	111 days

<b>BPD (mm)</b>	<b>GA (day)</b>	<b>5%</b>	<b>95%</b>
34 mm	105 days	96 days	114 days
35 mm	107 days	99 days	115 days
36 mm	109 days	101 days	118 days
37 mm	112 days	104 days	120 days
38 mm	114 days	105 days	123 days
39 mm	116 days	108 days	125 days
40 mm	119 days	110 days	127 days
41 mm	121 days	112 days	130 days
42 mm	123 days	115 days	132 days
43 mm	125 days	116 days	134 days
44 mm	127 days	118 days	136 days
45 mm	130 days	121 days	139 days
46 mm	132 days	123 days	141 days
47 mm	134 days	125 days	144 days
48 mm	136 days	126 days	146 days
49 mm	138 days	127 days	148 days
50 mm	140 days	130 days	148 days
51 mm	143 days	133 days	153 days
52 mm	145 days	135 days	155 days
53 mm	147 days	136 days	158 days
54 mm	150 days	140 days	160 days
55 mm	152 days	142 days	161 days
56 mm	154 days	145 days	163 days
57 mm	156 days	147 days	165 days
58 mm	159 days	150 days	167 days
59 mm	161 days	151 days	171 days
60 mm	163 days	153 days	172 days
61 mm	165 days	155 days	175 days
62 mm	168 days	158 days	178 days
63 mm	170 days	160 days	179 days
64 mm	172 days	162 days	182 days
65 mm	174 days	165 days	184 days

<b>BPD (mm)</b>	<b>GA (day)</b>	<b>5%</b>	<b>95%</b>
66 mm	176 days	167 days	187 days
67 mm	178 days	169 days	190 days
68 mm	181 days	171 days	191 days
69 mm	183 days	174 days	193 days
70 mm	185 days	175 days	195 days
71 mm	187 days	177 days	199 days
72 mm	190 days	179 days	200 days
73 mm	192 days	182 days	205 days
74 mm	195 days	183 days	207 days
75 mm	197 days	185 days	209 days
76 mm	200 days	187 days	212 days
77 mm	202 days	190 days	215 days
78 mm	205 days	191 days	220 days
79 mm	208 days	192 days	224 days
80 mm	210 days	195 days	225 days
81 mm	213 days	198 days	228 days
82 mm	217 days	202 days	232 days
83 mm	219 days	203 days	236 days
84 mm	223 days	206 days	240 days
85 mm	226 days	209 days	242 days
86 mm	229 days	211 days	246 days
87 mm	233 days	212 days	253 days
88 mm	236 days	217 days	255 days
89 mm	240 days	221 days	259 days
90 mm	243 days	224 days	262 days
91 mm	246 days	225 days	271 days
92 mm	251 days	233 days	275 days
93 mm	257 days	236 days	278 days
94 mm	262 days	243 days	281 days
95 mm	269 days	247 days	287 days
96 mm	272 days	247 days	290 days
97 mm	273 days	251 days	294 days

BPD (mm)	GA (day)	5%	95%
98 mm	275 days	255 days	294 days
99 mm	276 days	256 days	298 days
100 mm	277 days	257 days	296 days
101 mm	278 days	260 days	298 days
102 mm	279 days	260 days	296 days
103 mm	280 days	261 days	296 days
104 mm	281 days	262 days	296 days
105 mm	282 days	265 days	296 days

## CROWN-RUMP LENGTH (GA BY CRL)

### ASUM2003

**Name:** ASUM 2003

**Author:** ASUM

**Year:** 2003

**Reference:** ASUM and Campbell Westerway S , Ultrasonic fetal Measurement Standards for an Australian Population, ASUM, 2003

Input parameter: CRL (mm)

Min limit: 1

Max limit: 87

Output: GA (week)

Equation:

$$-0.0007 * \_CRL * \_CRL + 0.1584 * \_CRL + 5.2876$$

## Jeanty1984

**Name:** Jeanty 1984

**Author:** Jeanty

**Year:** 1984

**Reference:** Jeanty P and Romero R, Obstetrical Ultrasound, McGraw-Hill, 1984

CRL (mm)	GA (wd)
5 mm	6w2d
6 mm	6w4d
7 mm	6w5d
8 mm	6w6d
9 mm	7w1d
10 mm	7w2d
11 mm	7w3d
12 mm	7w4d
13 mm	7w6d
14 mm	7w6d
15 mm	8w1d
16 mm	8w1d
17 mm	8w3d
18 mm	8w4d
19 mm	8w4d
20 mm	8w6d
21 mm	8w6d
22 mm	9w0d
23 mm	9w1d
24 mm	9w1d
25 mm	9w3d
26 mm	9w4d
27 mm	9w4d

<b>CRL (mm)</b>	<b>GA (wd)</b>
28 mm	9w5d
29 mm	9w6d
30 mm	9w6d
31 mm	10w0d
32 mm	10w1d
33 mm	10w1d
34 mm	10w2d
35 mm	10w3d
36 mm	10w4d
37 mm	10w4d
38 mm	10w5d
39 mm	10w6d
40 mm	10w6d
41 mm	11w0d
42 mm	11w1d
43 mm	11w1d
44 mm	11w1d
45 mm	11w2d
46 mm	11w3d
47 mm	11w4d
48 mm	11w4d
49 mm	11w5d
50 mm	11w6d
51 mm	11w6d
52 mm	11w6d
53 mm	12w0d
54 mm	12w1d

## Hansmann 1986

**Name:** Hansmann 1986

**Author:** Hansmann

**Year:** 1986

**Reference:** Hansmann, Hackeloer, Staudach and Wittman, Ultrasound Diagnosis in Obstetrics and Gynecology, Springer-Verlag, New York, 1986

CRL (mm)	GA (wd)	- 2SD	+ 2SD
6 mm	6w1d	5w1d	7w0d
7 mm	6w2d	5w3d	7w2d
8 mm	6w4d	5w4d	7w3d
9 mm	6w6d	5w6d	7w6d
10 mm	7w0d	6w1d	8w0d
11 mm	7w2d	6w2d	8w1d
12 mm	7w3d	6w3d	8w3d
13 mm	7w4d	6w5d	8w4d
14 mm	7w6d	6w6d	8w6d
15 mm	8w0d	7w0d	9w0d
16 mm	8w2d	7w2d	9w1d
17 mm	8w3d	7w3d	9w2d
18 mm	8w4d	7w4d	9w4d
19 mm	8w5d	7w5d	9w5d
20 mm	8w6d	7w6d	9w6d
21 mm	9w0d	8w0d	10w0d
22 mm	9w1d	8w1d	10w1d
23 mm	9w2d	8w2d	10w2d
24 mm	9w3d	8w3d	10w3d
26 mm	9w5d	8w5d	10w5d
28 mm	10w0d	8w6d	11w1d
30 mm	10w2d	9w1d	11w2d
32 mm	10w3d	9w2d	11w4d

<b>CRL (mm)</b>	<b>GA (wd)</b>	<b>- 2SD</b>	<b>+ 2SD</b>
34 mm	10w5d	9w4d	11w5d
36 mm	10w6d	9w5d	12w0d
38 mm	11w1d	9w6d	12w2d
40 mm	11w2d	10w1d	12w3d
42 mm	11w3d	10w2d	12w4d
44 mm	11w4d	10w3d	12w6d
46 mm	11w6d	10w5d	13w0d
48 mm	12w0d	10w6d	13w2d
50 mm	12w1d	10w6d	13w3d
52 mm	12w2d	11w0d	13w4d
54 mm	12w3d	11w0d	13w5d
56 mm	12w4d	11w1d	13w6d
58 mm	12w5d	11w2d	14w0d
60 mm	12w6d	11w3d	14w1d
63 mm	13w0d	11w4d	14w3d
66 mm	13w2d	11w5d	14w5d
70 mm	13w3d	12w0d	15w0d
73 mm	13w5d	12w1d	15w1d
76 mm	13w6d	12w2d	15w3d
80 mm	14w1d	12w4d	15w5d
83 mm	14w2d	12w5d	16w0d
86 mm	14w4d	12w6d	16w2d
90 mm	14w6d	13w1d	16w4d
93 mm	15w1d	13w3d	16w6d
96 mm	15w3d	13w4d	17w1d
100 mm	15w5d	13w6d	17w3d
103 mm	16w0d	14w1d	17w6d
106 mm	16w2d	14w3d	18w1d
110 mm	16w4d	14w5d	18w4d
113 mm	17w0d	15w0d	19w0d
116 mm	17w2d	15w2d	19w2d
120 mm	17w4d	15w4d	19w4d



CRL (mm)	GA (wd)	- 2SD	+ 2SD
123 mm	18w0d	16w0d	20w0d
126 mm	18w2d	16w2d	20w3d
130 mm	18w6d	16w5d	20w6d
133 mm	19w1d	17w0d	21w2d
136 mm	19w4d	17w3d	21w6d
140 mm	20w0d	17w6d	22w2d
143 mm	20w3d	18w1d	22w5d
146 mm	20w6d	18w4d	23w1d
150 mm	21w3d	19w0d	23w5d

## FEMUR LENGTH (GA BY FL)

### ASUM2003

**Name:** ASUM 2003

**Author:** ASUM

**Year:** 2003

**Reference:** ASUM and Campbell Westerway S , Ultrasonic fetal Measurement Standards for an Australian Population, ASUM, 2003

Input parameter: FL (mm)

Min limit: 8

Max limit: 77

Output: GA (week)

Equation:

$$0.41 * \_FL - 0.002884 * \_FL * \_FL + 0.00003924 * \_FL * \_FL * \_FL + 8.284$$

## CFEF2000

**Name:** CFEF

**Author:** CFEF

**Year:** 2000

**Reference:** Crequat J, Duyme M and Brodaty G, Fetal growth charts by the French College of fetal ultrasonography and the Inserm U 155 , Biometry 2000, 28, pp 435-455, 2000

**Comments:** <http://cfef.org/>

FL (mm)	GA (week)
6.33 mm	12 weeks
9.88 mm	13 weeks
13.33 mm	14 weeks
16.66 mm	15 weeks
19.95 mm	16 weeks
23.12 mm	17 weeks
26.23 mm	18 weeks
29.25 mm	19 weeks
32.23 mm	20 weeks
35.05 mm	21 weeks
37.87 mm	22 weeks
40.5 mm	23 weeks
43.16 mm	24 weeks
45.69 mm	25 weeks
48.17 mm	26 weeks
50.53 mm	27 weeks
52.8 mm	28 weeks
54.94 mm	29 weeks
57.13 mm	30 weeks
59.15 mm	31 weeks
61.11 mm	32 weeks
63 mm	33 weeks

FL (mm)	GA (week)
64.76 mm	34 weeks
66.47 mm	35 weeks
68.13 mm	36 weeks
69.63 mm	37 weeks
71.11 mm	38 weeks
72.48 mm	39 weeks
73.79 mm	40 weeks
74 mm	41 weeks

## Chitty1997

**Name:** Chitty 1997

**Author:** Chitty

**Year:** 1997

**Reference:** Altman D.G and Chitty L.S, New charts for ultrasound dating of pregnancy, Ultrasound Obstet. Gynecol, Vol 10, pp 174-191, 1997

FL (mm)	GA (wd)	5%	95%
10 mm	13w0d	12w1d	13w6d
11 mm	13w2d	12w3d	14w1d
12 mm	13w4d	12w5d	14w4d
13 mm	13w6d	13w0d	14w6d
14 mm	14w1d	13w1d	15w1d
15 mm	14w3d	13w3d	15w3d
16 mm	14w5d	13w5d	15w6d
17 mm	15w0d	14w0d	16w1d
18 mm	15w2d	14w2d	16w3d
19 mm	15w5d	14w4d	16w6d
20 mm	16w0d	14w6d	17w1d
21 mm	16w2d	15w1d	17w3d

<b>FL (mm)</b>	<b>GA (wd)</b>	<b>5%</b>	<b>95%</b>
22 mm	16w4d	15w3d	17w6d
23 mm	16w6d	15w5d	18w1d
24 mm	17w2d	16w0d	18w4d
25 mm	17w4d	16w2d	18w6d
26 mm	17w6d	16w4d	19w2d
27 mm	18w2d	16w6d	19w5d
28 mm	18w4d	17w1d	20w0d
29 mm	18w6d	17w4d	20w3d
30 mm	19w2d	17w6d	20w5d
31 mm	19w4d	18w1d	21w1d
32 mm	20w0d	18w3d	21w4d
33 mm	20w2d	18w5d	22w0d
34 mm	20w5d	19w1d	22w2d
35 mm	21w0d	19w3d	22w5d
36 mm	21w3d	19w5d	23w1d
37 mm	21w5d	20w1d	23w4d
38 mm	22w1d	20w3d	24w0d
39 mm	22w4d	20w5d	24w3d
40 mm	22w6d	21w1d	24w6d
41 mm	23w2d	21w3d	25w2d
42 mm	23w5d	21w6d	25w5d
43 mm	24w1d	22w1d	26w1d
44 mm	24w3d	22w4d	26w4d
45 mm	24w6d	22w6d	27w1d
46 mm	25w2d	23w2d	27w4d
47 mm	25w5d	23w4d	28w0d
48 mm	26w1d	24w0d	28w3d
49 mm	26w4d	24w3d	29w0d
50 mm	27w0d	24w5d	29w3d
51 mm	27w3d	25w1d	30w0d
52 mm	27w6d	25w4d	30w3d
53 mm	28w2d	26w0d	31w0d

FL (mm)	GA (wd)	5%	95%
54 mm	28w5d	26w2d	31w3d
55 mm	29w2d	26w5d	32w0d
56 mm	29w5d	27w1d	32w3d
57 mm	30w1d	27w4d	33w0d
58 mm	30w4d	28w0d	33w4d
59 mm	31w1d	28w3d	34w1d
60 mm	31w4d	28w6d	34w4d
61 mm	32w1d	29w2d	35w1d
62 mm	32w4d	29w5d	35w5d
63 mm	33w1d	30w1d	36w2d
64 mm	33w4d	30w4d	36w6d
65 mm	34w1d	31w0d	37w3d
66 mm	34w4d	31w3d	38w0d
67 mm	35w1d	32w0d	38w5d

## Hadlock 1984

**Name:** Hadlock 1984

**Author:** Hadlock

**Year:** 1984

**Reference:** Hadlock F.P, Deter R.L, Harrist R.B. and Park S.K, Estimating fetal age: computer-assisted analysis of multiple fetal growth parameters, Radiology, 152, pp 497-501, 1984

FL (cm)	GA (week)	+/- 2SD
0.7 cm	12.1553 weeks	1.38 weeks
0.9 cm	12.7017 weeks	1.38 weeks
1.1 cm	13.2617 weeks	1.38 weeks
1.2 cm	13.5468 weeks	1.38 weeks
1.4 cm	14.1272 weeks	1.38 weeks
1.6 cm	14.7212 weeks	1.38 weeks

<b>FL (cm)</b>	<b>GA (week)</b>	<b>+/- 2SD</b>
1.7 cm	15.0233 weeks	1.38 weeks
1.9 cm	15.6377 weeks	1.38 weeks
2 cm	15.95 weeks	1.38 weeks
2.2 cm	16.5848 weeks	1.38 weeks
2.4 cm	17.2332 weeks	1.38 weeks
2.5 cm	17.5625 weeks	1.38 weeks
2.7 cm	18.2313 weeks	1.8 weeks
2.8 cm	18.5708 weeks	1.8 weeks
3 cm	19.26 weeks	1.8 weeks
3.1 cm	19.6097 weeks	1.8 weeks
3.3 cm	20.3193 weeks	1.8 weeks
3.4 cm	20.6792 weeks	1.8 weeks
3.5 cm	21.0425 weeks	1.8 weeks
3.7 cm	21.7793 weeks	1.8 weeks
3.8 cm	22.1528 weeks	1.8 weeks
4 cm	22.91 weeks	1.8 weeks
4.1 cm	23.2937 weeks	1.8 weeks
4.2 cm	23.6808 weeks	1.8 weeks
4.4 cm	24.4652 weeks	2.08 weeks
4.5 cm	24.8625 weeks	2.08 weeks
4.6 cm	25.2632 weeks	2.08 weeks
4.7 cm	25.6673 weeks	2.08 weeks
4.9 cm	26.4857 weeks	2.08 weeks
5 cm	26.9 weeks	2.08 weeks
5.1 cm	27.3177 weeks	2.08 weeks
5.2 cm	27.7388 weeks	2.08 weeks
5.4 cm	28.5912 weeks	2.08 weeks
5.5 cm	29.0225 weeks	2.08 weeks
5.6 cm	29.4572 weeks	2.08 weeks
5.7 cm	29.8953 weeks	2.08 weeks
5.8 cm	30.3368 weeks	2.96 weeks
5.9 cm	30.7817 weeks	2.96 weeks

FL (cm)	GA (week)	+/- 2SD
6 cm	31.23 weeks	2.96 weeks
6.1 cm	31.6817 weeks	2.96 weeks
6.2 cm	32.1368 weeks	2.96 weeks
6.3 cm	32.5953 weeks	2.96 weeks
6.4 cm	33.0572 weeks	2.96 weeks
6.5 cm	33.5225 weeks	2.96 weeks
6.6 cm	33.9912 weeks	2.96 weeks
6.7 cm	34.4633 weeks	2.96 weeks
6.8 cm	34.9388 weeks	2.96 weeks
6.9 cm	35.4177 weeks	2.96 weeks
7 cm	35.9 weeks	3.12 weeks
7.1 cm	36.3857 weeks	3.12 weeks
7.2 cm	36.8748 weeks	3.12 weeks
7.3 cm	37.3673 weeks	3.12 weeks
7.4 cm	37.8632 weeks	3.12 weeks
7.5 cm	38.3625 weeks	3.12 weeks
7.6 cm	38.8652 weeks	3.12 weeks
7.7 cm	39.3713 weeks	3.12 weeks

## Jeanty1984

**Name:** Jeanty 1984

**Author:** Jeanty

**Year:** 1984

**Reference:** Jeanty P and Romero R, Obstetrical Ultrasound, McGraw-Hill, 1984

FL (mm)	GA (wd)	5%	95%
10 mm	12w4d	10w3d	14w6
11 mm	12w6d	10w5d	15w1
12 mm	13w2d	11w1d	15w4

<b>FL (mm)</b>	<b>GA (wd)</b>	<b>5%</b>	<b>95%</b>
13 mm	13w4d	11w3d	15w6
14 mm	13w6d	11w5d	16w1
15 mm	14w1d	12w0d	16w3
16 mm	14w4d	12w3d	16w6
17 mm	14w6d	12w5d	17w1
18 mm	15w1d	13w0d	17w3
19 mm	15w4d	13w3d	17w6
20 mm	15w6d	13w5d	18w1
21 mm	16w2d	14w1d	18w4
22 mm	16w4d	14w3d	18w6
23 mm	16w6d	14w5d	19w1
24 mm	17w2d	15w1d	19w4
25 mm	17w4d	15w3d	19w6
26 mm	18w0d	15w6d	20w1
27 mm	18w2d	16w1d	20w4
28 mm	18w5d	16w4d	20w6
29 mm	19w0d	16w6d	21w1
30 mm	19w3d	17w1d	21w4
31 mm	19w6d	17w4d	22w0
32 mm	20w1d	17w6d	22w2
33 mm	20w4d	18w2d	22w5
34 mm	20w6d	18w5d	23w1
35 mm	21w1d	19w0d	23w3
36 mm	21w4d	19w3d	23w6
37 mm	22w0d	19w6d	24w1
38 mm	22w3d	20w1d	24w4
39 mm	22w5d	20w4d	24w6
40 mm	23w1d	20w6d	25w2
41 mm	23w4d	21w2d	25w5
42 mm	23w6d	21w5d	26w1
43 mm	24w2d	22w1d	26w4
44 mm	24w5d	22w4d	26w6



<b>FL (mm)</b>	<b>GA (wd)</b>	<b>5%</b>	<b>95%</b>
45 mm	25w0d	22w6d	27w1
46 mm	25w3d	23w1d	27w4
47 mm	25w6d	23w4d	28w0
48 mm	26w1d	24w0d	28w3
49 mm	26w4d	24w3d	28w6
50 mm	27w0d	24w6d	29w1
51 mm	27w3d	25w1d	29w4
52 mm	27w6d	25w4d	30w0
53 mm	28w1d	26w0d	30w3
54 mm	28w4d	26w3d	30w6
55 mm	29w1d	26w6d	31w2
56 mm	29w4d	27w2d	31w5
57 mm	29w6d	27w5d	32w1
58 mm	30w2d	28w1d	32w4
59 mm	30w5d	28w4d	32w6
60 mm	31w1d	28w6d	33w2
61 mm	31w4d	29w3d	33w6
62 mm	32w0d	29w6d	34w1
63 mm	32w3d	30w1d	34w4
64 mm	32w6d	30w5d	35w1
65 mm	33w2d	31w1d	35w4
66 mm	33w5d	31w4d	35w6
67 mm	34w1d	32w0d	36w3
68 mm	34w4d	32w3d	36w6
69 mm	35w0d	32w6d	37w1
70 mm	35w4d	33w2d	37w5
71 mm	35w6d	33w5d	38w1
72 mm	36w3d	34w1d	38w4
73 mm	36w6d	34w4d	39w0
74 mm	37w2d	35w1d	39w4
75 mm	37w5d	35w4d	39w6
76 mm	38w1d	36w0d	40w3

FL (mm)	GA (wd)	5%	95%
77 mm	38w4d	36w3d	40w6
78 mm	39w1d	36w6d	41w2
79 mm	39w4d	37w2d	41w5
80 mm	40w0d	37w6d	42w1

## Merz1988

**Name:** Merz 1988

**Author:** Merz

**Year:** 1988

**Reference:** Merz E, Goldhofer W and Timor-Tritsch E , Ultrasound in Gynecology and Obstetrics, Textbook and Atlas, Georg Thieme Verlag , 1991

**Comments:** From Merz E, Habilitationsschrift, Mainz University Woman's Hospital, 1988

FL (mm)	GA (wd)	5%	95%
10 mm	12w2d	11w1d	13w4d
11 mm	12w5d	11w4d	13w6d
12 mm	13w0d	11w6d	14w1d
13 mm	13w2d	12w1d	14w4d
14 mm	13w5d	12w3d	15w0d
15 mm	14w0d	12w5d	15w2d
16 mm	14w3d	13w1d	15w5d
17 mm	14w5d	13w3d	16w0d
18 mm	15w1d	13w6d	16w3d
19 mm	15w3d	14w1d	16w5d
20 mm	15w6d	14w4d	17w1d
21 mm	16w1d	14w6d	17w3d
22 mm	16w4d	15w1d	17w6d
23 mm	16w6d	15w3d	18w1d

<b>FL (mm)</b>	<b>GA (wd)</b>	<b>5%</b>	<b>95%</b>
24 mm	17w1d	15w6d	18w4d
25 mm	17w4d	16w1d	19w1d
26 mm	17w6d	16w3d	19w3d
27 mm	18w2d	16w6d	19w6d
28 mm	18w4d	17w1d	20w1d
29 mm	19w0d	17w4d	20w4d
30 mm	19w3d	17w6d	20w6d
31 mm	19w5d	18w1d	21w1d
32 mm	20w1d	18w4d	21w4d
33 mm	20w4d	18w6d	22w1d
34 mm	20w6d	19w1d	22w3d
35 mm	21w1d	19w4d	22w6d
36 mm	21w4d	20w0d	23w1d
37 mm	21w6d	20w2d	23w4d
38 mm	22w2d	20w5d	23w6d
39 mm	22w5d	21w0d	24w3d
40 mm	23w1d	21w3d	24w6d
41 mm	23w3d	21w5d	25w1d
42 mm	23w6d	22w1d	25w4d
43 mm	24w1d	22w4d	25w6d
44 mm	24w4d	22w6d	26w3d
45 mm	25w0d	23w1d	26w6d
46 mm	25w3d	23w4d	27w1d
47 mm	25w6d	24w0d	27w4d
48 mm	26w1d	24w3d	28w0d
49 mm	26w4d	24w5d	28w2d
50 mm	26w6d	25w1d	28w5d
51 mm	27w2d	25w4d	29w1d
52 mm	27w5d	25w6d	29w4d
53 mm	28w1d	26w1d	30w0d
54 mm	28w4d	26w4d	30w4d
55 mm	29w0d	27w0d	31w0d

FL (mm)	GA (wd)	5%	95%
56 mm	29w3d	27w3d	31w3d
57 mm	29w6d	27w6d	31w6d
58 mm	30w1d	28w1d	32w1d
59 mm	30w4d	28w4d	32w4d
60 mm	31w0d	29w0d	33w0d
61 mm	31w4d	29w4d	33w4d
62 mm	31w6d	29w6d	33w6d
63 mm	32w2d	30w2d	34w2d
64 mm	32w6d	30w6d	34w6d
65 mm	33w1d	31w1d	35w1d
66 mm	33w4d	31w4d	35w4d
67 mm	34w1d	32w0d	36w1d
68 mm	34w4d	32w3d	36w4d
69 mm	35w0d	32w6d	37w1d
70 mm	35w3d	33w2d	37w4d
71 mm	35w6d	33w6d	38w0d
72 mm	36w2d	34w1d	38w3d
73 mm	36w6d	34w4d	39w0d
74 mm	37w2d	35w1d	39w4d
75 mm	37w5d	36w0d	39w6d
76 mm	38w1d	36w0d	40w3d
77 mm	38w5d	36w4d	40w6d
78 mm	39w1d	37w0d	41w3d
79 mm	39w4d	37w3d	41w6d
80 mm	40w1d	37w6d	42w2d

## Hansmann1986

**Name:** Hansmann 1986

**Author:** Hansmann

**Year:** 1986

**Reference:** Hansmann, Hackeloer, Staudach and Wittman, *Ultrasound Diagnosis in Obstetrics and Gynecology*, Springer-Verlag, New York, 1986

FL (cm)	GA (week)
1 cm	13 weeks
1.2 cm	14 weeks
1.6 cm	15 weeks
1.8 cm	16 weeks
2.2 cm	17 weeks
2.5 cm	18 weeks
2.8 cm	19 weeks
3.1 cm	20 weeks
3.4 cm	21 weeks
3.6 cm	22 weeks
3.9 cm	23 weeks
4.1 cm	24 weeks
4.4 cm	25 weeks
4.7 cm	26 weeks
4.9 cm	27 weeks
5.1 cm	28 weeks
5.4 cm	29 weeks
5.6 cm	30 weeks
5.9 cm	31 weeks
6.1 cm	32 weeks
6.3 cm	33 weeks
6.5 cm	34 weeks
6.7 cm	35 weeks
6.9 cm	36 weeks
7.1 cm	37 weeks
7.3 cm	38 weeks
7.4 cm	39 weeks

FL (cm)	GA (week)
7.5 cm	40 weeks

## GESTATIONAL SAC (GA BY GS)

### Daya 1991

**Name:** Daya 1991

**Author:** Daya

**Year:** 1991

**Reference:** Daya S, Woods S, Ward S, Lappalainen R and Caco R, Early pregnancy assessment with transvaginal ultrasound scanning, CMAJ, Vol 144(4), pp 441-446, 1991

GS (mm)	GA (day)	5%	95%
2 mm	34.9 days	31.6 days	38.2 days
3 mm	35.8 days	32.5 days	39.1 days
4 mm	36.6 days	33.3 days	39.9 days
5 mm	37.5 days	34.2 days	40.8 days
6 mm	38.4 days	35.1 days	41.7 days
7 mm	39.3 days	36 days	42.6 days
8 mm	40.2 days	36.9 days	43.5 days
9 mm	41.1 days	37.8 days	44.3 days
10 mm	41.9 days	38.7 days	45.2 days
11 mm	42.8 days	39.5 days	46.1 days
12 mm	43.7 days	40.4 days	47 days
13 mm	44.6 days	41.3 days	47.9 days
14 mm	45.5 days	42.2 days	48.7 days
15 mm	46.3 days	43.1 days	49.6 days
16 mm	47.2 days	44 days	50.5 days
17 mm	48.1 days	44.8 days	51.4 days

GS (mm)	GA (day)	5%	95%
18 mm	49 days	45.7 days	52.3 days
19 mm	49.9 days	46.6 days	53.2 days
20 mm	50.8 days	47.5 days	54 days
21 mm	51.6 days	48.3 days	54.9 days
22 mm	52.5 days	49.2 days	55.8 days
23 mm	53.4 days	50.1 days	56.7 days
24 mm	54.3 days	51 days	57.6 days
25 mm	55.2 days	51.9 days	58.5 days
26 mm	56 days	52.7 days	59.4 days
27 mm	56.9 days	53.6 days	60.3 days
28 mm	57.8 days	54.5 days	61.1 days
29 mm	58.7 days	55.4 days	62 days
30 mm	59.6 days	56.2 days	62.9 days

## HEAD CIRCUMFERENCE (GA BY HC)

### ASUM2003

**Name:** ASUM 2003

**Author:** ASUM

**Year:** 2003

**Reference:** ASUM and Campbell Westerway S , Ultrasonic fetal Measurement Standards for an Australian Population, ASUM, 2003

Input parameter: HC (mm)

Min limit: 59

Max limit: 344

Output: GA (week)

Equation:

$$0.0001797 * \_HC * \_HC + 0.02631 * \_HC + 9.667$$

CFEF2000

**Name:** CFEF

**Author:** CFEF

**Year:** 2000

**Reference:** Crequat J, Duyme M and Brodaty G, Fetal growth charts by the French College of fetal ultrasonography and the Inserm U 155 , Biometry 2000, 28, pp 435-455, 2000

**Comments:** <http://cfef.org/>

HC (mm)	GA (week)
120.86 mm	16 weeks
134.49 mm	17 weeks
147.55 mm	18 weeks
160.29 mm	19 weeks
172.47 mm	20 weeks
184.21 mm	21 weeks
195.74 mm	22 weeks
206.64 mm	23 weeks
217.18 mm	24 weeks
227.32 mm	25 weeks
236.72 mm	26 weeks
246 mm	27 weeks
254.77 mm	28 weeks
263 mm	29 weeks
270.84 mm	30 weeks
278.33 mm	31 weeks
285.29 mm	32 weeks
292 mm	33 weeks



HC (mm)	GA (week)
298.1 mm	34 weeks
303.62 mm	35 weeks
308.81 mm	36 weeks
313.52 mm	37 weeks
317.88 mm	38 weeks
321.86 mm	39 weeks
324 mm	40 weeks

## Chitty1997

**Name:** Chitty 1997

**Author:** Chitty 1997

**Year:** 1997

**Reference:** Altman D.G and Chitty L.S, New charts for ultrasound dating of pregnancy, Ultrasound Obstet. Gynecol, Vol 10, pp 174-191, 1997

HC (mm)	GA (wd)	5%	95%
85 mm	12w6d	12w1d	13w4d
90 mm	13w2d	12w4d	14w0d
95 mm	13w5d	12w6d	14w3d
100 mm	14w0d	13w2d	14w6d
105 mm	14w3d	13w4d	15w2d
110 mm	14w6d	14w0d	15w6d
115 mm	15w2d	14w3d	16w2d
120 mm	15w5d	14w5d	16w5d
125 mm	16w1d	15w1d	17w1d
130 mm	16w3d	15w3d	17w4d
135 mm	16w6d	15w6d	18w0d
140 mm	17w2d	16w1d	18w3d
145 mm	17w5d	16w4d	18w6d

HC (mm)	GA (wd)	5%	95%
150 mm	18w1d	17w0d	19w2d
155 mm	18w3d	17w2d	19w5d
160 mm	18w6d	17w5d	20w1d
165 mm	19w2d	18w0d	20w4d
170 mm	19w5d	18w3d	21w0d
175 mm	20w0d	18w5d	21w3d
180 mm	20w3d	19w1d	21w6d
185 mm	20w6d	19w3d	22w2d
190 mm	21w2d	19w6d	22w6d
195 mm	21w5d	20w1d	23w2d
200 mm	22w0d	20w4d	23w5d
205 mm	22w3d	20w6d	24w1d
210 mm	22w6d	21w2d	24w4d
215 mm	23w2d	21w5d	25w0d
220 mm	23w5d	22w0d	25w4d
225 mm	24w1d	22w3d	26w0d
230 mm	24w4d	22w6d	26w3d
235 mm	25w0d	23w1d	27w0d
240 mm	25w3d	23w4d	27w3d
245 mm	25w6d	24w0d	28w0d
250 mm	26w3d	24w3d	28w3d
255 mm	26w6d	24w6d	29w0d
260 mm	27w3d	25w2d	29w4d
265 mm	27w6d	25w5d	30w1d
270 mm	28w3d	26w2d	30w5d
275 mm	29w0d	26w5d	31w2d
280 mm	29w4d	27w2d	32w0d
285 mm	30w1d	27w5d	32w4d
290 mm	30w5d	28w2d	33w2d
295 mm	31w2d	28w6d	34w0d
300 mm	32w0d	29w3d	34w5d
305 mm	32w5d	30w0d	35w3d

HC (mm)	GA (wd)	5%	95%
310 mm	33w3d	30w5d	36w2d
315 mm	34w1d	31w2d	37w1d
320 mm	34w6d	32w0d	38w0d
325 mm	35w5d	32w5d	38w6d

## Hadlock 1984

**Name:** Hadlock 1984

**Author:** Hadlock 1984

**Year:** 1984

**Reference:** Hadlock F.P, Deter R.L, Harrist R.B. and Park S.K, Estimating fetal age: computer-assisted analysis of multiple fetal growth parameters, Radiology, 152, pp 497-501, 1984

HC (cm)	GA (week)	+/- 2SD
6.8 cm	12.7263 weeks	1.19 weeks
7.5 cm	13.1366 weeks	1.19 weeks
8.2 cm	13.5534 weeks	1.19 weeks
8.9 cm	13.9775 weeks	1.19 weeks
9.7 cm	14.4718 weeks	1.19 weeks
10.4 cm	14.9135 weeks	1.19 weeks
11 cm	15.2993 weeks	1.19 weeks
11.7 cm	15.7585 weeks	1.19 weeks
12.4 cm	16.228 weeks	1.19 weeks
13.1 cm	16.7084 weeks	1.19 weeks
13.8 cm	17.2004 weeks	1.19 weeks
14.4 cm	17.6318 weeks	1.19 weeks
15.1 cm	18.1469 weeks	1.48 weeks
15.8 cm	18.6753 weeks	1.48 weeks
16.4 cm	19.1393 weeks	1.48 weeks
17 cm	19.6139 weeks	1.48 weeks

HC (cm)	GA (week)	+/- 2SD
17.7 cm	20.1816 weeks	1.48 weeks
18.3 cm	20.6805 weeks	1.48 weeks
18.9 cm	21.1914 weeks	1.48 weeks
19.5 cm	21.7145 weeks	1.48 weeks
20.1 cm	22.2502 weeks	1.48 weeks
20.7 cm	22.7989 weeks	1.48 weeks
21.3 cm	23.3611 weeks	1.48 weeks
21.9 cm	23.937 weeks	1.48 weeks
22.4 cm	24.4278 weeks	2.06 weeks
23 cm	25.0301 weeks	2.06 weeks
23.5 cm	25.5434 weeks	2.06 weeks
24.1 cm	26.1733 weeks	2.06 weeks
24.6 cm	26.7101 weeks	2.06 weeks
25.1 cm	27.258 weeks	2.06 weeks
25.6 cm	27.8172 weeks	2.06 weeks
26.1 cm	28.3879 weeks	2.06 weeks
26.6 cm	28.9703 weeks	2.06 weeks
27.1 cm	29.5648 weeks	2.06 weeks
27.5 cm	30.0491 weeks	2.06 weeks
28 cm	30.6656 weeks	2.06 weeks
28.4 cm	31.1679 weeks	2.98 weeks
28.8 cm	31.6784 weeks	2.98 weeks
29.3 cm	32.3281 weeks	2.98 weeks
29.7 cm	32.8574 weeks	2.98 weeks
30.1 cm	33.3953 weeks	2.98 weeks
30.4 cm	33.8043 weeks	2.98 weeks
30.8 cm	34.3574 weeks	2.98 weeks
31.2 cm	34.9194 weeks	2.98 weeks
31.5 cm	35.3468 weeks	2.98 weeks
31.8 cm	35.7792 weeks	2.98 weeks
32.2 cm	36.3639 weeks	2.98 weeks
32.5 cm	36.8084 weeks	2.98 weeks

HC (cm)	GA (week)	+/- 2SD
32.8 cm	37.2583 weeks	3.2 weeks
33 cm	37.5611 weeks	3.2 weeks
33.3 cm	38.0198 weeks	3.2 weeks
33.5 cm	38.3286 weeks	3.2 weeks
33.8 cm	38.7963 weeks	3.2 weeks
34 cm	39.1112 weeks	3.2 weeks
34.2 cm	39.4285 weeks	3.2 weeks
34.4 cm	39.7483 weeks	3.2 weeks
34.6 cm	40.0705 weeks	3.2 weeks

## Jeanty1984

**Name:** Jeanty 1984

**Author:** Jeanty

**Year:** 1984

**Reference:** Jeanty P and Romero R, Obstetrical Ultrasound, McGraw-Hill, 1984

HC (mm)	GA (wd)	5%	95%
80 mm	13w2d	11w3d	15w2d
85 mm	13w5d	11w5d	15w4d
90 mm	14w0d	12w0d	15w6d
95 mm	14w2d	12w2d	16w2d
100 mm	14w4d	12w4d	16w4d
105 mm	14w6d	13w0d	16w6d
110 mm	15w2d	13w2d	17w1d
115 mm	15w4d	13w4d	17w4d
120 mm	15w6d	13w6d	17w6d
125 mm	16w2d	14w2d	18w1d
130 mm	16w4d	14w4d	18w4d
135 mm	16w6d	15w0d	18w6d

HC (mm)	GA (wd)	5%	95%
140 mm	17w2d	15w2d	19w2d
145 mm	17w4d	15w5d	19w4d
150 mm	18w0d	16w0d	20w0d
155 mm	18w3d	16w3d	20w2d
160 mm	18w5d	16w6d	20w5d
165 mm	19w1d	17w1d	21w1d
170 mm	19w4d	17w4d	21w3d
175 mm	19w6d	18w0d	21w6d
180 mm	20w2d	18w3d	22w2d
185 mm	20w5d	18w6d	22w5d
190 mm	21w1d	19w1d	23w1d
195 mm	21w4d	19w4d	23w4d
200 mm	22w0d	20w1d	24w0d
205 mm	22w3d	20w4d	24w3d
210 mm	23w0d	21w0d	24w6d
215 mm	23w3d	21w3d	25w3d
220 mm	23w6d	21w6d	25w6d
225 mm	24w3d	22w3d	26w2d
230 mm	24w6d	22w6d	26w6d
235 mm	25w3d	23w3d	27w2d
240 mm	25w6d	23w6d	27w6d
245 mm	26w3d	24w3d	28w2d
250 mm	26w6d	25w0d	28w6d
255 mm	27w3d	25w4d	29w3d
260 mm	28w0d	26w0d	30w0d
265 mm	28w4d	26w4d	30w4d
270 mm	29w1d	27w1d	31w1d
275 mm	29w5d	27w6d	31w5d
280 mm	30w2d	28w3d	32w2d
285 mm	31w0d	29w0d	32w6d
290 mm	31w4d	29w4d	33w4d
295 mm	32w1d	30w2d	34w1d

HC (mm)	GA (wd)	5%	95%
300 mm	32w6d	30w6d	34w6d
305 mm	33w4d	31w4d	35w3d
310 mm	34w1d	32w2d	36w1d
315 mm	34w6d	32w6d	36w6d
320 mm	35w4d	33w4d	37w4d
325 mm	36w2d	34w2d	38w2d
330 mm	37w0d	35w0d	39w0d
335 mm	37w5d	35w6d	39w5d
340 mm	38w4d	36w4d	40w3d
345 mm	39w2d	37w2d	41w2d
350 mm	40w0d	38w1d	42w0d
355 mm	40w6d	38w6d	42w6d
360 mm	41w5d	39w5d	43w4d

## Merz1988

**Name:** Merz 1988

**Author:** Merz

**Year:** 1988

**Reference:** Merz E, Goldhofer W and Timor-Tritsch E , Ultrasound in Gynecology and Obstetrics, Textbook and Atlas, Georg Thieme Verlag , 1991

**Comments:** From Merz E, Habilitationsschrift, Mainz University Woman's Hospital, 1988

HC (mm)	GA (wd)	5%	95%
72 mm	12w1d	11w0d	13w1d
74 mm	12w2d	11w1d	13w4d
76 mm	12w3d	11w1d	13w4d
78 mm	12w4d	11w2d	13w5d
80 mm	12w5d	11w4d	13w6d

HC (mm)	GA (wd)	5%	95%
82 mm	12w6d	11w4d	14w0d
84 mm	12w6d	11w5d	14w1d
86 mm	13w1d	11w6d	14w2d
88 mm	13w1d	12w0d	14w3d
90 mm	13w2d	12w1d	14w4d
92 mm	13w4d	12w2d	14w5d
94 mm	13w4d	12w3d	14w6d
96 mm	13w5d	12w4d	14w6d
98 mm	13w6d	12w5d	15w1d
100 mm	14w0d	12w6d	15w1d
102 mm	14w1d	12w6d	15w4d
104 mm	14w2d	13w0d	15w5d
106 mm	14w3d	13w1d	15w5d
108 mm	14w4d	13w2d	15w6d
110 mm	14w5d	13w3d	16w0d
112 mm	14w16d	13w4d	16w1d
114 mm	15w0d	13w5d	16w2d
116 mm	15w1d	13w6d	16w3d
118 mm	15w2d	14w0d	16w4d
120 mm	15w3d	14w1d	16w5d
122 mm	15w4d	14w1d	17w0d
124 mm	15w5d	14w2d	17w1d
126 mm	15w6d	14w3d	17w1d
128 mm	16w0d	14w4d	17w3d
130 mm	16w1d	14w5d	17w4d
132 mm	16w2d	14w6d	17w5d
134 mm	16w3d	15w0d	17w6d
136 mm	16w4d	15w1d	18w0d
138 mm	16w5d	15w2d	18w1d
140 mm	16w6d	15w4d	18w2d
142 mm	17w0d	15w4d	18w3d
144 mm	17w1d	15w6d	18w4d



HC (mm)	GA (wd)	5%	95%
146 mm	17w2d	15w6d	18w5d
148 mm	17w4d	16w0d	19w0d
150 mm	17w4d	16w1d	19w1d
152 mm	17w6d	16w2d	19w2d
154 mm	17w6d	16w3d	19w3d
156 mm	18w1d	16w4d	19w4d
158 mm	18w1d	16w5d	19w5d
160 mm	18w3d	16w6d	19w6d
162 mm	18w4d	17w0d	20w0d
164 mm	18w5d	17w1d	20w1d
166 mm	18w6d	17w2d	20w2d
168 mm	19w0d	17w4d	20w4d
170 mm	19w1d	17w4d	20w4d
172 mm	19w2d	17w6d	20w6d
174 mm	19w3d	17w6d	20w6d
176 mm	19w4d	18w0d	21w1d
178 mm	19w6d	18w1d	21w3d
180 mm	19w6d	18w2d	21w4d
182 mm	20w1d	18w4d	21w5d
184 mm	20w1d	18w4d	21w6d
186 mm	20w3d	18w6d	22w0d
188 mm	20w4d	19w0d	22w1d
190 mm	20w5d	19w1d	22w2d
192 mm	20w6d	19w2d	22w4d
194 mm	21w1d	19w4d	22w5d
196 mm	21w1d	19w4d	22w6d
198 mm	21w3d	19w5d	23w0d
200 mm	21w4d	19w6d	23w2d
202 mm	21w5d	20w0d	23w3d
204 mm	21w6d	20w1d	23w4d
206 mm	22w1d	20w3d	23w6d
208 mm	22w1d	20w4d	23w6d

HC (mm)	GA (wd)	5%	95%
210 mm	22w3d	20w5d	24w1d
212 mm	22w4d	20w6d	24w2d
214 mm	22w5d	21w0d	24w3d
216 mm	22w6d	21w1d	24w4d
218 mm	23w1d	21w3d	24w6d
220 mm	23w2d	21w4d	25w0d
222 mm	23w4d	21w6d	25w1d
224 mm	23w4d	21w6d	25w2d
226 mm	23w6d	22w1d	25w4d
228 mm	24w0d	22w1d	25w6d
230 mm	24w1d	22w3d	26w0d
232 mm	24w3d	22w4d	26w1d
234 mm	24w4d	22w5d	26w2d
236 mm	24w5d	22w6d	26w4d
238 mm	24w6d	23w1d	26w5d
240 mm	25w1d	23w2d	26w6d
242 mm	25w2d	23w4d	27w1d
244 mm	25w4d	23w5d	27w2d
246 mm	25w5d	23w6d	27w4d
248 mm	25w6d	24w1d	27w5d
250 mm	26w0d	24w1d	27w6d
252 mm	26w1d	24w3d	28w0d
254 mm	26w3d	24w4d	28w1d
256 mm	26w4d	24w6d	28w3d
258 mm	26w6d	25w0d	28w4d
260 mm	27w0d	25w1d	28w6d
262 mm	27w1d	25w3d	29w0d
264 mm	27w3d	25w4d	29w1d
266 mm	27w4d	25w6d	29w3d
268 mm	27w6d	26w0d	29w4d
270 mm	28w1d	26w1d	30w0d
272 mm	28w2d	26w3d	30w1d

HC (mm)	GA (wd)	5%	95%
274 mm	28w4d	26w4d	30w3d
276 mm	28w5d	26w6d	30w4d
278 mm	28w6d	27w0d	30w6d
280 mm	29w1d	27w1d	31w0d
282 mm	29w2d	27w3d	31w1d
284 mm	29w4d	27w5d	31w4d
286 mm	29w6d	27w6d	31w5d
288 mm	30w0d	28w1d	31w6d
290 mm	30w1d	28w2d	32w1d
292 mm	30w4d	28w4d	32w3d
294 mm	30w5d	28w6d	32w4d
296 mm	30w6d	29w0d	32w6d
298 mm	31w1d	29w1d	33w0d
300 mm	31w3d	29w3d	33w3d
302 mm	31w4d	29w4d	33w4d
304 mm	31w6d	29w6d	33w6d
306 mm	32w1d	30w1d	34w1d
308 mm	32w2d	30w2d	34w2d
310 mm	32w4d	30w4d	34w4d
312 mm	32w6d	30w6d	34w6d
314 mm	33w1d	31w1d	35w1d
316 mm	33w3d	31w3d	35w3d
318 mm	33w4d	31w4d	35w4d
320 mm	33w6d	31w6d	36w0d
322 mm	34w1d	32w0d	36w1d
324 mm	34w3d	32w2d	36w4d
326 mm	34w5d	32w4d	36w6d
328 mm	34w6d	32w6d	37w0d
330 mm	35w1d	33w1d	37w2d
332 mm	35w4d	33w2d	37w5d
334 mm	35w6d	33w4d	38w0d
336 mm	36w1d	33w6d	38w2d

HC (mm)	GA (wd)	5%	95%
338 mm	36w3d	34w1d	38w4d
340 mm	36w4d	34w3d	38w6d
342 mm	36w6d	34w5d	39w1d
344 mm	37w1d	35w0d	39w3d
346 mm	37w4d	35w2d	39w5d
348 mm	37w6d	35w4d	40w1d
350 mm	38w1d	35w6d	40w4d
352 mm	38w4d	36w1d	40w6d
354 mm	38w6d	36w4d	41w1d
356 mm	39w1d	36w6d	41w3d
358 mm	39w4d	37w1d	41w6d
360 mm	39w6d	37w4d	42w1d
362 mm	40w1d	37w6d	42w3d
364 mm	40w4d	38w1d	42w6d

## Hansmann 1986

**Name:** Hansmann 1986

**Author:** Hansmann

**Year:** 1986

**Reference:** Hansmann, Hackeloer, Staudach and Wittman, Ultrasound Diagnosis in Obstetrics and Gynecology, Springer-Verlag, New York, 1986

HC (cm)	GA (week)
10.6 cm	14 weeks
11.5 cm	15 weeks
12.7 cm	16 weeks
14 cm	17 weeks
15.2 cm	18 weeks
16.4 cm	19 weeks

HC (cm)	GA (week)
17.6 cm	20 weeks
19 cm	21 weeks
20.3 cm	22 weeks
21.5 cm	23 weeks
22.6 cm	24 weeks
24 cm	25 weeks
25.1 cm	26 weeks
26.3 cm	27 weeks
27.4 cm	28 weeks
28.4 cm	29 weeks
29.3 cm	30 weeks
30.3 cm	31 weeks
31.1 cm	32 weeks
31.8 cm	33 weeks
32.5 cm	34 weeks
33.2 cm	35 weeks
33.7 cm	36 weeks
34 cm	37 weeks
34.4 cm	38 weeks
34.7 cm	39 weeks
34.9 cm	40 weeks

## HUMERUS LENGTH (GA BY HL)

ASUM2003

**Name:** ASUM 2003

**Author:** ASUM

**Year:** 2003

**Reference:** ASUM and Campbell Westerway S , Ultrasonic fetal Measurement Standards for an Australian Population, ASUM, 2003

Input parameter: HL (mm)

Min limit: 8

Max limit: 68

Output: GA (week)

Equation:

$$0.406 * \text{HL} - 0.002804 * \text{HL} * \text{HL} + 0.0000563 * \text{HL} * \text{HL} * \text{HL} + 8.411$$

Jeanty1984

**Name:** Jeanty 1984

**Author:** Jeanty

**Year:** 1984

**Reference:** AJeanty P and Romero R, Obstetrical Ultrasound, McGraw-Hill, 1984

HL (mm)	GA (wd)	5%	95%
10 mm	12w4d	9w6d	15w2d
11 mm	12w6d	10w1d	15w4d
12 mm	13w1d	10w3d	15w6d
13 mm	13w4d	10w6d	16w1d
14 mm	13w6d	11w1d	16w4d
15 mm	14w1d	11w3d	16w6d
16 mm	14w4d	11w6d	17w2d
17 mm	14w6d	12w1d	17w4d
18 mm	15w1d	12w4d	18w0d
19 mm	15w4d	12w6d	18w2d

HL (mm)	GA (wd)	5%	95%
20 mm	15w6d	13w1d	18w5d
21 mm	16w2d	13w4d	19w1d
22 mm	16w5d	13w6d	19w3d
23 mm	17w1d	14w2d	19w6d
24 mm	17w3d	14w5d	20w1d
25 mm	17w6d	15w1d	20w4d
26 mm	18w1d	15w4d	21w0d
27 mm	18w4d	15w6d	21w3d
28 mm	19w0d	16w2d	21w6d
29 mm	19w3d	16w5d	22w1d
30 mm	19w6d	17w1d	22w4d
31 mm	20w2d	17w4d	23w0d
32 mm	20w5d	18w0d	23w4d
33 mm	21w1d	18w3d	23w6d
34 mm	21w4d	18w6d	24w2d
35 mm	22w0d	19w2d	24w6d
36 mm	22w4d	19w5d	25w1d
37 mm	22w6d	20w1d	25w5d
38 mm	23w3d	20w4d	26w1d
39 mm	23w6d	21w1d	26w4d
40 mm	24w2d	21w4d	27w1d
41 mm	24w6d	22w0d	27w4d
42 mm	25w2d	22w4d	28w0d
43 mm	25w5d	23w0d	28w4d
44 mm	26w1d	23w4d	29w0d
45 mm	26w5d	24w0d	29w4d
46 mm	27w1d	24w4d	30w0d
47 mm	27w5d	25w0d	30w4d
48 mm	28w1d	25w4d	31w0d
49 mm	28w6d	26w0d	31w4d
50 mm	29w2d	26w4d	32w0d
51 mm	29w6d	27w1d	32w4d

HL (mm)	GA (wd)	5%	95%
52 mm	30w2d	27w4d	33w1d
53 mm	30w6d	28w1d	33w4d
54 mm	31w3d	28w5d	34w1d
55 mm	32w0d	29w1d	34w5d
56 mm	32w4d	29w6d	35w2d
57 mm	33w1d	30w2d	35w6d
58 mm	33w4d	30w6d	36w3d
59 mm	34w1d	31w3d	36w6d
60 mm	34w6d	32w0d	37w4d
61 mm	35w2d	32w4d	38w1d
62 mm	35w6d	33w1d	38w5d
63 mm	36w4d	33w6d	39w2d
64 mm	37w1d	34w3d	39w6d
65 mm	37w5d	35w0d	40w4d
66 mm	38w2d	35w4d	41w1d
67 mm	38w6d	36w1d	41w5d
68 mm	39w4d	36w6d	42w2d
69 mm	40w1d	37w3d	42w6d

## OCCIPITO-FRONTAL DIAMETER (OFD)

### ASUM2003

**Name:** ASUM 2003

**Author:** ASUM

**Year:** 2003

**Reference:** ASUM and Campbell Westerway S , Ultrasonic fetal Measurement Standards for an Australian Population, ASUM, 2003

Input parameter: OFD (mm)



Min limit: 21

Max limit: 122

Output: Gest Age (week)

Equation:

$$0.381 * \text{\_OFD} - 0.00344 * \text{\_OFD} * \text{\_OFD} + 0.00002298 * \text{\_OFD} * \text{\_OFD} * \text{\_OFD} + 4.189$$

Hansmann1986

**Name:** Hansmann 1986

**Author:** Hansmann

**Year:** 1986

**Reference:** Hansmann, Hackeloer, Staudach and Wittman, Ultrasound Diagnosis in Obstetrics and Gynecology, Springer-Verlag, New York, 1986

OFD (cm)	GA (week)
3.1 cm	14 weeks
3.8 cm	15 weeks
4.1 cm	16 weeks
4.6 cm	17 weeks
5 cm	18 weeks
5.4 cm	19 weeks
5.8 cm	20 weeks
6.3 cm	21 weeks
6.7 cm	22 weeks
7.2 cm	23 weeks

OFD (cm)	GA (week)
7.6 cm	24 weeks
8 cm	25 weeks
8.4 cm	26 weeks
8.8 cm	27 weeks
9.1 cm	28 weeks
9.5 cm	29 weeks
9.8 cm	30 weeks
10 cm	31 weeks
10.3 cm	32 weeks
10.5 cm	33 weeks
10.7 cm	34 weeks
10.9 cm	35 weeks
11.1 cm	36 weeks
11.2 cm	37 weeks
11.3 cm	38 weeks
11.4 cm	39 weeks
11.5 cm	40 weeks

## TRANS-ABDOMINAL DIAMETER (GA BY TAD)

CFEF2000

**Name:** CFEF

**Author:** CFEF

**Year:** 2000

**Reference:** Crequat J, Duyme M and Brodaty G, Fetal growth charts by the French College of fetal ultrasonography and the Inserm U 155 , Biometry 2000, 28, pp 435-455, 2000

**Comments:** [Fhttp://cfef.org/](http://cfef.org/)

<b>TAD (mm)</b>	<b>GA (week)</b>
13.5 mm	11 weeks
17 mm	12 weeks
20.56 mm	13 weeks
24 mm	14 weeks
27.69 mm	15 weeks
31.21 mm	16 weeks
34.7 mm	17 weeks
38.31 mm	18 weeks
41.69 mm	19 weeks
45.21 mm	20 weeks
48.34 mm	21 weeks
51.57 mm	22 weeks
54.72 mm	23 weeks
57.88 mm	24 weeks
61 mm	25 weeks
64 mm	26 weeks
67.11 mm	27 weeks
70.27 mm	28 weeks
73.27 mm	29 weeks
76.17 mm	30 weeks
79.25 mm	31 weeks
82.1 mm	32 weeks
84.78 mm	33 weeks
87.55 mm	34 weeks
90 mm	35 weeks
92.36 mm	36 weeks
94.81 mm	37 weeks
97 mm	38 weeks
99.33 mm	39 weeks
101.64 mm	40 weeks
103 mm	41 weeks

## TIBIA (GA BY TIB)

Jeanty1984

**Name:** Jeanty 1984

**Author:** Jeanty

**Year:** 1984

**Reference:** Jeanty P and Romero R, Obstetrical Ultrasound, McGraw-Hill, 1984

TIB (mm)	GA (wd)	5%	95%
10 mm	13w3d	10w4d	16w2d
11 mm	13w5d	10w6d	16w4d
12 mm	14w1d	11w1d	17w0d
13 mm	14w3d	11w4d	17w2d
14 mm	14w6d	11w6d	17w5d
15 mm	15w1d	12w1d	18w0d
16 mm	15w4d	12w4d	18w3d
17 mm	15w6d	13w0d	18w6d
18 mm	16w1d	13w2d	19w1d
19 mm	16w4d	13w5d	19w4d
20 mm	17w0d	14w1d	19w6d
21 mm	17w3d	14w4d	20w2d
22 mm	17w6d	14w6d	20w5d
23 mm	18w1d	15w1d	21w1d
24 mm	18w4d	15w4d	21w3d
25 mm	18w6d	16w0d	21w6d
26 mm	19w2d	16w3d	22w1d
27 mm	19w5d	16w6d	22w4d
28 mm	20w1d	17w1d	23w0d
29 mm	20w4d	17w4d	23w4d
30 mm	21w0d	18w1d	23w6d

<b>TIB (mm)</b>	<b>GA (wd)</b>	<b>5%</b>	<b>95%</b>
31 mm	21w3d	18w4d	24w2d
32 mm	21w6d	18w6d	24w5d
33 mm	22w1d	19w2d	25w1d
34 mm	22w4d	19w5d	25w4d
35 mm	23w1d	20w1d	26w0d
36 mm	23w4d	20w4d	26w3d
37 mm	23w6d	21w0d	26w6d
38 mm	24w3d	21w4d	27w2d
39 mm	24w6d	21w6d	27w5d
40 mm	25w2d	22w3d	28w1d
41 mm	25w5d	22w6d	28w4d
42 mm	26w1d	23w2d	29w1d
43 mm	26w4d	23w5d	29w4d
44 mm	27w1d	24w1d	30w0d
45 mm	27w4d	24w4d	30w4d
46 mm	28w0d	25w1d	30w6d
47 mm	28w4d	25w4d	31w3d
48 mm	29w0d	26w1d	31w6d
49 mm	29w3d	26w4d	32w2d
50 mm	29w6d	27w0d	32w6d
51 mm	30w3d	27w4d	33w2d
52 mm	30w6d	28w0d	33w6d
53 mm	31w3d	28w4d	34w2d
54 mm	31w6d	29w0d	34w6d
55 mm	32w3d	29w4d	35w2d
56 mm	32w6d	30w0d	35w6d
57 mm	33w3d	30w4d	36w2d
58 mm	33w6d	31w0d	36w6d
59 mm	34w3d	31w4d	37w2d
60 mm	34w6d	32w0d	37w6d
61 mm	35w3d	32w4d	38w2d
62 mm	35w6d	33w0d	38w6d

TIB (mm)	GA (wd)	5%	95%
63 mm	36w4d	33w4d	39w3d
64 mm	37w0d	34w1d	39w6d
65 mm	37w4d	34w4d	40w3d
66 mm	38w0d	35w1d	41w0d
67 mm	38w4d	35w5d	41w4d
68 mm	39w1d	36w1d	42w0d
69 mm	39w5d	36w6d	42w4d

## ULNA (GA BY ULNA)

Jeanty1984

**Name:** Jeanty 1984

**Author:** Jeanty

**Year:** 1984

**Reference:** Jeanty P and Romero R, Obstetrical Ultrasound, McGraw-Hill, 1984

ULNA (mm)	GA (wd)	5%	95%
10 mm	13w1d	10w1d	16w1d
11 mm	13w4d	10w4d	16w4d
12 mm	13w6d	10w6d	16w6d
13 mm	14w1d	11w1d	17w2d
14 mm	14w4d	11w4d	17w5d
15 mm	15w0d	11w6d	18w0d
16 mm	15w3d	12w2d	18w3d
17 mm	15w5d	12w5d	18w6d
18 mm	16w1d	13w1d	19w1d
19 mm	16w4d	13w4d	19w4d
20 mm	16w6d	13w6d	20w0d

ULNA (mm)	GA (wd)	5%	95%
21 mm	17w2d	14w2d	20w3d
22 mm	17w5d	14w5d	20w6d
23 mm	18w1d	15w1d	21w1d
24 mm	18w4d	15w4d	21w4d
25 mm	19w0d	16w0d	22w1d
26 mm	19w3d	16w3d	22w4d
27 mm	19w6d	16w6d	22w6d
28 mm	20w2d	17w2d	23w3d
29 mm	20w6d	17w5d	23w6d
30 mm	21w1d	18w1d	24w2d
31 mm	21w5d	18w4d	24w6d
32 mm	22w1d	19w1d	25w1d
33 mm	22w5d	19w4d	25w5d
34 mm	23w1d	20w1d	26w1d
35 mm	23w4d	20w4d	26w5d
36 mm	24w1d	21w1d	27w1d
37 mm	24w4d	21w4d	27w5d
38 mm	25w1d	22w1d	28w1d
39 mm	25w4d	22w4d	28w5d
40 mm	26w1d	23w1d	29w1d
41 mm	26w5d	23w4d	29w5d
42 mm	27w1d	24w1d	30w2d
43 mm	27w5d	24w5d	30w6d
44 mm	28w2d	25w1d	31w2d
45 mm	28w6d	25w6d	31w6d
46 mm	29w3d	26w2d	32w3d
47 mm	29w6d	26w6d	33w0d
48 mm	30w4d	27w3d	33w4d
49 mm	31w1d	28w0d	34w1d
50 mm	31w4d	28w4d	34w5d
51 mm	32w1d	29w1d	35w2d
52 mm	32w6d	29w5d	35w6d

ULNA (mm)	GA (wd)	5%	95%
53 mm	33w3d	30w2d	36w3d
54 mm	34w0d	30w6d	37w0d
55 mm	34w4d	31w4d	37w5d
56 mm	35w1d	32w1d	38w2d
57 mm	35w6d	32w6d	38w6d
58 mm	36w3d	33w3d	39w4d
59 mm	37w1d	34w0d	40w1d
60 mm	37w5d	34w4d	40w6d
61 mm	38w2d	35w2d	41w3d
62 mm	39w0d	35w6d	42w0d
63 mm	39w4d	36w4d	42w5d
64 mm	40w2d	37w1d	43w2d

## TRANSVERSE THORACIC DIAMETER (GA BY TTD)

Hansmann 1986

**Name:** Hansmann 1986

**Author:** Hansmann

**Year:** 1986

**Reference:** Hansmann, Hackeloer, Staudach and Wittman, *Ultrasound Diagnosis in Obstetrics and Gynecology*, Springer-Verlag, New York, 1986

TTD (cm)	GA (week)
1.7 cm	12 weeks
2 cm	13 weeks
2.4 cm	14 weeks
2.7 cm	15 weeks
3.1 cm	16 weeks



<b>TTD (cm)</b>	<b>GA (week)</b>
3.4 cm	17 weeks
3.7 cm	18 weeks
4 cm	19 weeks
4.4 cm	20 weeks
4.7 cm	21 weeks
5 cm	22 weeks
5.3 cm	23 weeks
5.6 cm	24 weeks
5.9 cm	25 weeks
6.2 cm	26 weeks
6.5 cm	27 weeks
6.9 cm	28 weeks
7.2 cm	29 weeks
7.4 cm	30 weeks
7.8 cm	31 weeks
8.1 cm	32 weeks
8.3 cm	33 weeks
8.6 cm	34 weeks
8.9 cm	35 weeks
9.2 cm	36 weeks
9.4 cm	37 weeks
9.7 cm	38 weeks
9.9 cm	39 weeks
10.1 cm	40 weeks

# Estimated Fetal Weight (EFW) Equations and Tables

## ABDOMINAL CIRCUMFERENCE AND BIPARIETAL DIAMETER (EFW BY AC, BPD)

Merz 1991

**Name:** Merz 1991 - EFW by AC and BPD

**Author:** Merz

**Year:** 1991

**Reference:** Merz E, Goldhofer W and Timor-Tritsch E , Ultrasound in Gynecology and Obstetrics, Textbook and Atlas, Georg Thieme Verlag , 1991

**Comments:** FFrom Merz E, Lieser H, Schicketanz KH and Härle J, Intrauterine fetal weight assessment using ultrasound. A comparison of several weight assessment methods and development of a new formula for the determination of fetal weight, Ultraschall Med, pp 15-24, 1988

Input parameter: AC (cm)

Min limit: 21

Max limit: 37

Input parameter: BPD (cm)

Min limit: 7

Max limit: 11

Ouput: EFW 2 (g)

Equation:

$$157.07186* \_ac + 15.90931* \_bpd^2 - 3200.40479$$

Hadlock 1984

**Name:** Hadlock 1984 - EFW by AC and BPD

**Author:** Hadlock

**Year:** 1984

**Reference:** Hadlock F.P, Harrist R.B, Carpenter R.J, Deter R.L and Park S.K, Sonographic estimation of fetal weight. The value of femur length in addition to head and abdomen measurements, Radiology, 150, pp 535-540, 1984

**Comments:** Mean deviation +/- SD (%) 0.4 +/- 9.1

Input parameter: AC (cm)

Min limit: 4.6

Max limit: 35.3

Input parameter: BPD (cm)

Min limit: 1.7

Max limit: 9.4

Output: EFW 2 (g)

Equation:

$$10^{(1.1134 + 0.05845* \_ac - 0.000604* \_ac^2 - 0.007365* \_bpd^2 + 0.000595* \_bpd^3 + 0.1694* \_bpd)}$$

ABDOMINAL CIRCUMFERENCE, BIPARIETAL  
DIAMETER AND FEMUR LENGTH (EFW BY AC,  
BPD, FL)

Hadlock 1985

**Name:** Hadlock 1985 - EFW by AC, BPD and FL

**Author:** Hadlock

**Year:** 1985

**Reference:** Hadlock F.P, Harrist R.B, Sharman R.S, Deter R.L, Park S.K, Estimation of fetal weight with the use of head, body, and femur measurements--a prospective study, Am.J.Obstet.Gynecol., 151, pp 333-337, 1985

**Comments:** Mean deviation +/- SD (%) 0.3 +/- 7.5

Input parameter: AC (cm)

Min limit: 4.6

Max limit: 35.3

Input parameter: BPD (cm)

Min limit: 1.7

Max limit: 9.4

Input parameter: FL (cm)

Min limit: 0.7

Max limit: 7.7

Output: EFW 3 (g)

Equation:  $10^{(1.335-0.0034*_{ac}*_{fl}+0.0316*_{bpd}+0.0457*_{ac}+0.1623*_{fl})}$

ABDOMINAL CIRCUMFERENCE, BIPARIETAL DIAMETER, FEMUR LENGTH AND HEAD CIRCUMFERENCE (EFW BY AC, BPD, FL, HC)

Hadlock 1985

**Name:** Hadlock 1985 - EFW by AC, BPD, FL and HC

**Author:** Hadlock

**Year:** 1985

**Reference:** Hadlock F.P, Harrist R.B, Sharman R.S, Deter R.L, Park S.K, Estimation of fetal weight with the use of head, body, and femur measurements--a prospective study, Am.J.Obstet.Gynecol., 151, pp 333-337, 1985

**Comments:** Mean deviation +/- SD (%) 0.1 +/- 7.4

Input parameter: AC (cm)

Min limit: 4.6

Max limit: 35.3

Input parameter: BPD (cm)

Min limit: 1.7

Max limit: 9.4

Input parameter: FL (cm)

Min limit: 0.7

Max limit: 7.7

Input parameter: HC (cm)

Min limit: 6.8

Max limit: 34.6

Output: EFW 4 (g)

Equation:  $10^{(1.3596-0.00386*_{ac}*_{fl}+0.0064*_{hc}+0.00061*_{bpd}*_{ac}+0.0424*_{ac}+0.174*_{fl})}$

## ABDOMINAL CIRCUMFERENCE AND FEMUR LENGTH (EFW BY AC, FL)

Hadlock 1985

**Name:** Hadlock 1985 - EFW by AC and FL

**Author:** Hadlock

**Year:** 1985

**Reference:** Hadlock F.P, Harrist R.B, Sharman R.S, Deter R.L, Park S.K, Estimation of fetal weight with the use of head, body, and femur measurements--a prospective study, Am.J.Obstet.Gynecol., 151, pp 333-337, 1985

**Comments:** Mean deviation +/- SD (%) 0.3 +/- 8.0

Input parameter: AC (cm)

Min limit: 4.6

Max limit: 35.3

Input parameter: FL (cm)

Min limit: 0.7

Max limit: 7.7

Output: EFW 2 (g)

Equation:  $10^{(1.304+0.05281*_{ac}+0.1938*_{fl}-0.004*_{ac}*_{fl})}$

ABDOMINAL CIRCUMFERENCE, FEMUR LENGTH  
AND HEAD CIRCUMFERENCE (EFW BY AC, FL,  
HC)

Hadlock 1985

**Name:** Hadlock 1985 - EFW by AC, FL and HC

**Author:** Hadlock

**Year:** 1985

**Reference:** Hadlock F.P, Harrist R.B, Sharman R.S, Deter R.L, Park S.K, Estimation of fetal weight with the use of head, body, and femur measurements--a prospective study, Am.J.Obstet.Gynecol., 151, pp 333-337, 1985

**Comments:** Mean deviation +/- SD (%) 0.0 +/- 7.5

Input parameter: AC (cm)

Min limit: 4.6

Max limit: 35.3

Input parameter: FL (cm)

Min limit: 0.7

Max limit: 7.7

Input parameter: HC (cm)

Min limit: 6.8

Max limit: 34.6

Output: EFW 3 (g)

Equation:  $10^{(1.326-0.00326*_{ac}*_{fl}+0.0107*_{hc}+0.0438*_{ac}+0.158*_{fl})}$

## ABDOMINAL CIRCUMFERENCE AND HEAD CIRCUMFERENCE (EFW BY AC, HC)

Hadlock 1984

**Name:** Hadlock 1984 - EFW by AC and HC

**Author:** Hadlock

**Year:** 1984

**Reference:** Hadlock F.P, Harrist R.B, Carpenter R.J, Deter R.L and Park S.K, Sonographic estimation of fetal weight. The value of femur length in addition to head and abdomen measurements, Radiology, 150, pp 535-540, 1984

**Comments:** Mean deviation +/- SD (%) 0.4 +/- 9.1

Input parameter: AC (cm)

Min limit: 4.6

Max limit: 35.3

Input parameter: HC (cm)

Min limit: 6.8

Max limit: 34.6



Ouput: EFW 2 (g)

Equation:  $10^{(1.182+0.0273* \text{hc} +0.07057* \text{ac}-0.00063* \text{ac}^2-0.0002184* \text{hc}* \text{ac})}$

BIPARIETAL DIAMETER AND TDD (EFW BY BPD, TDD)

Hansmann 1986

**Name:** Hansmann 1986 - EFW by BPD and TTD

**Author:** Hansmann

**Year:** 1986

**Reference:** Hansmann, Hackeloer, Staudach and Wittman, Ultrasound Diagnosis in Obstetrics and Gynecology, Springer-Verlag, New York, 1986

**Comments:** Mean deviation +/- SD (%) 15.8

Input parameter: BPD (cm)

Min limit: 6

Max limit: 10.9

Input parameter: TTD (cm)

Min limit: 4.9

Max limit: 12.1

Ouput: EFW 2 (kg)

Equation:  $=- 1.05775 * \text{bpd} + 0.649145 * \text{ttd} + 0.0930707 * \text{bpd}^2 - 0.020562 * \text{ttd}^2 + 0.515263$



# Index

## Symbols

- 3D Imaging, 221
  - 3D and SWE, 226
  - 3D History Loop, 226
  - 3D Measurements, 227
- Acquisition, 221
  - Multi Slice (MS), 224
  - Multi-Planar Reconstruction (MPR), 222

## A

- Absorption, 59
- Accessories
  - Gels, 120
  - Transducer Sheaths, 121
- Accuracy (see Measurements Accuracy)
- Acoustic Output Detailed Reporting, 397
  - Mode Summary Table, 400
  - SC6-1 Transducer, 409
  - SE12-3 Transducer, 414
  - SL10-2 Transducer, 429
  - SL15-4 Transducer, 403
  - SLV16-5 Transducer, 422
  - SMC12-3 Transducer, 436
  - Symbols, 399
- Acoustic Power
  - B-mode, 167
  - CEUS, 236
  - Color Modes, 199
  - M-mode, 244
  - PW, 213
  - SWE, 188

- Additional Video Devices, 23
- Air Filters
  - Cleaning, 382
  - Recommended Cleaning Frequency, 379
- ALARA
  - Applying ALARA with the Aixplorer, 86
  - Controlling energy, 71
  - Controlling exposure time, 71
  - Controlling scanning technique, 72
  - Controlling system setup, 72
  - Effects of operating mode, 74
  - Effects of system capabilities, 72
  - Effects of transducer capabilities, 74
  - Practicing the ALARA Principle, 82
  - The ALARA Principle, 71
- Alarm System, 99
- Annotations
  - Annotation Library, 252
  - Home position, 252
- Audio Adjustment, 109
- AutoTGC (see Time Gain Compensation (TGC))

## B

- B-Mode, 163
  - Scanning Tips, 181
- Baseline
  - Color, 198

- PW, 215
  - Beginning an Exam, 142
  - BI-RADS, 288
  - Bioeffects and Biophysics of Ultrasound Interactions, 47
  - Biopsy
    - Biopsy Guidelines, 170
    - Compatible Biopsy Guides, 129
  - Blending, 201
  - Body Markers, 248
- C**
- Cable Holder, 112
  - Capturing Images and Clips, 311
  - Cavitation
    - Cavitation and Role of Gas Bubbles, 63
    - Factors Generating Cavitation, 63
    - Types of Cavitation, 64
  - CD/DVD Drive, 19
  - Certifications, 8
  - Cleaning and Disinfection Products, 388
    - For the SC6-1, 388
    - For the SE12-3, 389
    - For the SL10-2, 388
    - For the SL15-4, 388
    - For the SMC12-3, 388
  - Cleaning the System, 379
  - Clinical Application Examples
    - Abdominal/Pelvic, 94
    - Endocavitary, 95
    - MSK, 93
    - Obstetrics, 97
    - Small Parts, 92
    - Vascular, 96
  - Clinical Data Export, 324
  - Clips
    - Play, 160
  - Color Modes, 191
    - Color Flow imaging (CFI), 191
    - Color Power imaging (CPI), 191
    - Directional Color Power imaging (dCPI), 192
    - Scanning TIPS, 207
  - Color Priority, 200
  - Comparing images, 318
  - Conformance Standards, 7
  - Contact Us
    - China, 10
    - France, 9
    - Germany, 10
    - North America, 9
    - Service, 10
    - United Kingdom, 9
  - Contraindications, 6
  - Contrast Agent, 234
  - Contrast Enhanced Ultrasound Imaging (CEUS), 230
    - Scanning TIPS, 239
  - Contrast Imaging (see Contrast Enhanced Ultrasound Imaging (CEUS))
  - Control Panel
    - Cleaning, 381
    - Cleaning Frequency, 379
    - How to Move the Control Panel, 109
    - How to Swivel the Control Panel, 109
    - Knobology, 134
  - Customizing the System, 337
    - Administration, 352
    - Device Settings, 346
    - Measurements, 370
    - System Diagnostics, 376
    - System/Display, 340
- D**
- Date and time, setting, 342
  - Declaration of Electromagnetic Emissions, 40
  - Declaration of Immunity, 41

- Depth, 155
- DICOM
  - Devices, 353
  - DICOM Conformance Statement, 329
  - DICOM options, 349
  - DICOM Printer, 320
  - Icons, 152
- Digital Zoom, 158
- Dimensions of the system, 15
- Disinfectants (see Cleaning and Disinfection Products)
- Disk Maintenance, 356
- Display Format
  - M-mode, 245
  - PW, 214
  - SWE, 187
- Display unit, 186
- Doppler Line, 211
- Dual imaging, 159
- Duplex Mode (see Simultaneous Duplex and Triple Modes)
- DVD
  - Drive, location, 19
  - How to eject, 322
- DVI Port, 19
- Dynamic Range
  - B-mode, 166
  - CEUS, 237

## E

- Elasticity Range, 186
- Electrical Operating Requirements, 16
- Electromagnetic Emissions (see Declaration of Electromagnetic Emissions)
- Electromagnetic Interference, 35
- Ending an Exam, 148, 335
- Entering Patient Data, 142

## F

- Fine Angle Correct, 213
- Flash, 236
- Flash Power, 237
- Flash Suppression, 201
- Focal Zone (see Transmit Focal Zone)
- Foot Rests, 116
- Footswitch, 18
- Freeze, 155

## G

- Gain, 156
- Gel
  - Gel Holders, 113
  - Recommended Gels, 120
- Getting Started, 137

## H

- Handles, 115
- Hard Drive Maintenance (see Disk Maintenance)
- Harmonic Imaging, 165
- Heat Conduction Effect, 60
- Hide Color, 197
- Hide Patient Name, 161
- High PRF, 216

## I

- Icons (see Notification Icons)
- Image Orientation
  - Left/Right, 159
  - Top/Bottom, 159
- Imaging Modes, 149
- Immunity (see Declaration of Immunity)
- Indications for Use, 6
- Indices as Indicators of Thermal and Mechanical Effects, 54
- Intended Use, 5
- Invert
  - Color, 196

PW, 214

## K

Keyboard, 143  
Knobology, 134

## L

Labeled Measurements (see  
Measurements)  
Languages, 342  
Latex  
    Allergic Reactions, 126  
    Transducer Sheaths, 121  
Left/Right (see Image Orientation  
Left/Right)

## M

M-Mode, 240  
Measurements, 254  
    3D Measurements, 227  
    Accuracy, 273  
    Curved Distance, 176  
    d:D, 258  
    Distance, 254  
    Doppler Slope, 264  
    Doppler Trace, 264  
    Ellipse, 255  
    Functionalities, 270  
    Hip Angle, 258  
    ICA/CCA, 266  
    IMT, 259  
    Multi Q-Box, 269  
    PSV/EDV, 263  
    Q-Box, 268  
    Q-Box Ratio, 268  
    Q-Box Trace, 268  
    Trace, 256  
    Volume, 258  
Mechanical Index (MI), 55, 76,  
151  
Mechanisms for Thermal and Non-  
Thermal Bioeffects, 50

Modality Worklist, 145

Monitor

    Cleaning, 381  
    Description, 108  
    Display, 151  
    Recommended Cleaning  
    Frequency, 379

Moving the System, 117

MPR (see Multi-Planar  
Reconstruction)

Multi Slice (MS), 224

    Active view, 225  
    Display, 225  
    Navigation, 225

Multi-Planar Reconstruction, 222

    Active view, 222  
    Display, 222  
    Navigation, 223  
    Rotation, 223

MVI, 235

## N

Network

    Configuration, 354  
    Tools, 355

Notification Icons, 152

## O

On-Cart Storage, 113

On/Off

    Symbols, 30  
    Turning the System On and Off,  
137

Opacity, 187

Output Display Standard, 75

## P

Panoramic, 172

Patents, iii

Patient Data

    Creating a New Patient, 142  
    Editing Patient Data, 147

- Loading a Patient file from the Modality Worklist, 145
- Patient Directory, 316
- Patient Reports (see Reports)
- Persistence
  - B-mode, 168
  - Color, 200
  - SWE, 189
- Physical Overview, 13
- POI, 235
- Potential Hazards at High Output Levels, 49
- Power
  - Cable, 119
  - Switch, 137
- Presets, 359
- Printers
  - Additional Printer, 21
  - Configuration, 353
  - Integrated Printers, 21
- Printing Images, 319
- Prospective Clip, 312
- Pulse Repetition Frequency (PRF)
  - PRF, 167
- Pulse Wave Velocity (PWV), 178
- Pulsed Wave Doppler (PW), 209
- PWV (see Pulse Wave Velocity (PWV))

## Q

- Query and Retrieve, 328

## R

- Radiation Force, 65
- References, 441
- Reports, 295
  - Generating Reports, 308
  - Report Builder, 297
- Retrospective Clip, 311
- Reviewing an Exam, 315

## S

- Safety
  - Electrical Safety, 34
  - General Equipment Safety, 32
  - Mechanical Safety, 45
  - Safely Performing Ultrasound Examinations with the SuperSonic Imagine Aixplorer System, 47
  - Thermal Safety, 44
- Sample Volume
  - Position, 211
  - Size, 211
- Scale
  - Color, 198
  - PW, 215
- Scattering, 61
- Sending a Study, 321
- Service, 10, 11
- ShearWave Elastography, 182
  - Scanning TIPS, 190
- Sheaths
  - For the SC6-1, 122
  - For the SE12-3, 123
  - For the SL10-2, 125
  - For the SL15-4, 122
  - For the SLV16-5, 124
  - For the SMC12-3, 125
- Simultaneous Duplex and Triple Modes, 216
- Smoothing
  - Color, 199
  - M-mode, 246
  - SWE, 189
- Speakers, 109
- Speed of Sound (see TissueTuner)
- Steering
  - Color, 199
  - PW, 212
- Storage Area, 114
- Storing Aixplorer, 25

SuperCompound, 167  
SuperRes, 168  
SWE (see ShearWave Elastography)  
SWE Optimization, 185  
Sweep Speed, 216  
Sweep Speed; M-mode, 245  
Symbols, 30  
System Configuration (see Customizing the System)  
System Overview, 105

## T

Temperature, Pressure and Humidity Limits, 25  
TGC (see Time Gain Compensation (TGC))  
Thermal Bioeffects, 56  
Thermal Index (TI), 76, 78, 151  
Thumbnails, 317  
Thy-RADS, 291  
Time and date, setting (see Date and time, setting)  
Time Gain Compensation (TGC), 156  
    Auto TGC Offset, 168  
    AutoTGC, 156  
    ManualTouchTGC, 157  
Timer, 236  
TissueTuner, 166  
Top/Bottom (see Image Orientation Top/Bottom)  
Touch Screen  
    Cleaning, 381  
    Description, 154  
    Knobology, 136  
Transducers  
    Cleaning and Disinfection, 386  
    Connecting, 111  
    Selecting, 141  
    Sheaths, 121  
    Storing, 112

Transmit Focal Zone, 157  
Troubleshooting, 393

## U

UltraFast Doppler, 201  
Ultrasound Use, 48  
Upgrades and Updates, 12  
USB Ports, 17

## V

Velocity Optimization, 197  
Velocity Range, 186  
Volume Measurements  
    2D, 258  
    3D, 227

## W

Wall Filter  
    Color, 197  
    PW, 215  
Wheel Locks, 116  
Worklist (see Modality Worklist)  
Worksheet, 303

## Z

Zoom, 158  
    HD Zoom, 158



# 13 NOTES











**SuperSonic Imagine, S.A.**

Les Jardins de la Duranne - Bât. E et F  
510 rue René Descartes  
F - 13857 Aix-en-Provence, Cedex - France

Telephone: +33 (0)442 99 24 32  
Fax: +33 (0)442 52 59 21  
Email: [contactsFR@supersonicimagine.fr](mailto:contactsFR@supersonicimagine.fr)